

2022



**MARINA**  
Stores

**CATALOGUE**

# Sales Alert

Explore MARINA Stores Sales Alert and find out our special offers.

Stay always tuned in order to seize every opportunity, buying our products in discount, both online at [www.marinastores.gr](http://www.marinastores.gr) and through our retail stores network.



# PROMOTION

**What could be better than welcoming each month with a new offer?**

At MARINA Stores through the Products' Promotion in the beginning of each month, we inform you about the products that have the most advantageous prices depending on the season.

All you have to do is to follow our updates on social media, newsletters or text messages. Don't also forget to visit our official website [www.marinastores.gr](http://www.marinastores.gr).



# OUTLET

**Is it possible to find products with a discount up to -96%?**

In our Outlet category, yes it is! These are products with limited stock & at fantastic prices.

New products are being added as Outlet, on a regular basis, and you can find them online and in store.

\*Outlet products are not combined with other offers and prices are valid as long as there is available stock.



# MARINA

Stores

## WHAT MAKES US UNIQUE

Wide range of available codes



Products from leading manufacturers

Lofrans!  
WINDLASSES

MAX  
POWER

LALIZAS

ARIMAR

Nova Rade

OCEAN®

Immediate stock availability  
in our central warehouse

Perfect customer service from  
our experienced and highly  
knowledgeable staff



Exclusive offers  
on a monthly basis

**PROMOTION**

**%**

**Complete support**

Stores

● GREECE ● CROATIA ● MONTENEGRO ● CYPRUS

Webshop

[www.marinastores.gr](http://www.marinastores.gr)

**new**

**ARIMAR**



**ARIMAR COASTAL LIGHT Liferaft**  
Page 44



**SOFT LINE**  
Page 118



**SUP**  
Page 358

**Nuova Rade**



**Electric Horns**  
Page 165

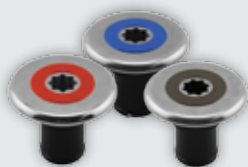

**INOX Deck Filler**  
Page 196



**Solar Powered Marine Light**  
Page 331

**SEA NAV**



**Binoculars**  
Page 261



**Fuel Primer Bulb**  
Page 158



**Two-way Speakers**  
Page 346

**SEA COVER**



**Jet Ski Cover**  
Page 229

**Lofrans**  
WINDLABBES



**Winch Handles**  
Page 235

**LALIZAS**



**Dry Bag**  
Page 386



**Gangway Carbon, Folding**  
Page 115

**new**

New Product



Two Colours



One Colour



Best Quality



Taped Seams



Easy mounting



Water Proof 100%



Unisex



Suitable for OFFSHORE



Suitable for COASTAL



Suitable for RACING



Guarantee



CE Approved



Pre-wired



Batteries Operated



Child



Suitable for FISHING



Suitable for SKI and JET SKI



Suitable for CANOE / KAYAK

## Contents

			Safety_____4-63
			Anchoring, Docking & Mooring__64-115
			Boats, Engines & Accessories_116-172
			Deck Equipment_____173-232
			Sailing Hardware_____233-247
			Electronics & Navigation_____248-269
			Plumbing & Ventilation_____270-312
			Electrical Equipment_____313-347
			Interior Equipment & Galley___348-357
			Watersports & Fishing_____358-376
			Clothing & Accessories_____377-388
			Cleaning & Maintenance_____389-399
			Index_____400-404
			

# Safety



Inflatable Lifejackets	5-12	Liferafts	36-48
Inflatable Lifejackets Accessories	13-15	Liferaft Equipment	49-52
Foam Lifejackets	16-20	Breathing Apparatus	52-53
Watersports Buoyancy Aids	20-22	Fire Fighting Equipmnet	53-56
Pet Buoyancy Aids	22-23	Marine Distress Signals & Pyrotechnics	56-59
Lifesaving Lights	23-25	Smoke Detectors	60
MOB Systems	25-34	Emergency Equipment Devices	60-61
Sea Anchors-Drogues	34-35	Medical Equipmnet	62
Retroreflective Tapes	35	IMO Signs	63
Immersion Suits	35-36		

The main priority in every trip at sea is to ensure the safety of all persons on board.

Every boat must have the necessary safety equipment in order to meet the requirements of the Authorities as well as to ensure the maximum possible safety of the passengers.

At MARINA Stores you will find approved inflatable lifejackets, buoyancy aids as well as MOB systems with the signature of the leading manufacturer of lifesaving equipment, LALIZAS.

Equip your boat by choosing what you need from a wide range of liferafts by LALIZAS, which guarantees comfort, stable cruising, and also space saving on board.



Quick burst zipper & automatic activation of inflator



Indicator window for easy check of the inflator status



Soft neoprene fabric at neck and chest areas



Quick adjusting & easy fit



Soft D-Ring & Safety knife pocket



Twin crotch-straps and lifting loops



**Kappa Inflatable Lifejacket, Auto, 180N, with Double Crotch & Harness, ISO**

- Certified per ISO 12402-3 & ISO 12401
- Ergonomic design, providing the advantage of unrestricted motion when on board
- Made of Nylon rip stop with PU coating and soft neoprene fabric for neck and chest areas
- Indicator window for easy check of the inflator status

Code	72194	72195
Adult	✓	✓
Automatic Inflator	LALIZAS JS1	HAMMAR MA1



**Kappa**  
LALIZAS

Ergonomic design  
High quality  
**LALIZAS**



**Theta Inflatable Lifejacket, Auto, 290N, with Sprayhood, Double Crotch & Harness, ISO**

- Certified per ISO 12402-2 & ISO 12401
- A complete and reliable solution for all seafarers looking for ultimate safety and style on board
- Ergonomic design offering unrestricted motion and comfort even when worn with heavy-duty clothing
- Made of Nylon rip stop with PU coating and soft neoprene fabric for neck and chest area

Code	72196	72197
Adult	✓	✓
Automatic Inflator	LALIZAS JS1	HAMMAR MA1

**Theta**  
LALIZAS



## Sigma Inflatable Lifejacket, 170N, ISO

- Certified per ISO 12402-3
- Auto & manual version
- Comfortable to wear & user-friendly due to its ultra-lightweight design and webbing system
- Transparent area allows the user to check the function of the operating head (this applies to certain codes)
- Ultra reliable auto-firing mechanism which is specially designed not to be unintentionally activated due to heavy weather
- Commercial heavy-duty protective outer cover
- Easy re-packing



**Combine with**  
LALIZAS Lifejacket  
LED flashing light  
page 23



Code	71094	71096	71097	720811	72081
Colour	●	●	●	●	●
Adult	✓	✓	✓	✓	✓
Automatic Inflator	✓	✓		✓	✓
Manual Inflator			✓		
Plastic Buckle					
Zipper					
D-ring / Harness	✓			✓	✓
Clip Crotch Strap				✓	✓
LALIZAS JS1	✓	✓			✓
Hammar MA1				✓	
Work Vest					

Safety





Safety



Zipper



Plastic Buckle

CE

**DESIGNED FOR  
EXTRA ERGONOMIC COMFORT**



Code	72154	72560	725601	72561	725611
Colour					
Adult	✓	✓	✓	✓	✓
Automatic Inflator	✓	✓	✓	✓	✓
Manual Inflator					
Plastic Buckle		✓	✓	✓	✓
Zipper				✓	✓
D-ring / Harness				✓	✓
Clip Crotch Strap				✓	✓
LALIZAS JS1	✓	✓	✓	✓	✓
Hammar MA1					
Work Vest	✓				

Safety



**Zeta Inflatable Lifejacket, Auto, 290N, ISO**

- Certified per ISO 12402-2
- Ergonomic lifejacket that is comfortable to wear & user-friendly due to its webbing system

Code	72399	72400
Colour	●	●
Adult	✓	✓
Automatic Inflator (LALIZAS JS1)	✓	✓
D-ring / Harness	✓	
Clip crotch strap	✓	
Durable PVC fabric cover		✓
Work Vest		✓

**Zeta** <sup>290N</sup> LALIZAS

CE

Work Vest



**Combine with**  
LALIZAS Lifejacket  
LED flashing light  
page 23



**Alpha Inflatable Lifejacket, 170N, ISO**

- Certified per ISO 12402-3
- Certified per ISO 12401 on all integral black harnesses
- Auto & manual version
- Compact design, low weight and high-quality construction
- Ideal for the coastal and inshore yachtsmen
- Ultra reliable firing mechanism
- Commercial heavy-duty protective outer cover
- Easy re-packing

Code	71098	71100	71101	71102
Adult	✓	✓	✓	
Child				✓
Automatic Inflator (LALIZAS JS1)	✓	✓		✓
Manual Inflator			✓	
D-ring / Harness	✓			✓

**Alpha** <sup>LALIZAS</sup> 170N

CE



**Combine with**  
Harness & Lifejacket  
Crotch Strap  
page 15



**Omega Inflatable Lifejacket, Auto, 290N, ISO**

- Certified per ISO 12402-2
- Certified per ISO 12401 on all integral black harnesses
- Slim fit, lightweight, with rugged constructions
- Coming in two codes, one with harness and one without harness
- Ultra reliable firing mechanism
- Commercial heavy-duty protective outer cover
- Easy re-packing

Code	71103	71105
Adult	✓	✓
Automatic Inflator (LALIZAS JS1)	✓	✓
D-ring / Harness	✓	



Safety



**Vita Inflatable Lifejacket, Manual, 120N, ISO**

- Certified per ISO 12402-4 & 12402-6 for ultimate safety while on board
- Designed to cover marine market's need for an ultra-lightweight lifejacket
- Reflective tapes and oral inflation tube with non-return valve (20610, certified per ISO 12402-7)
- Plastic buckle for quick closure & release
- Ideal for civil transport vessels and tourist boats
- Provided in transparent vacuumed pack



Vacuum packed  
Easy-to-store  
Saves valuable stowage space



*If package is without damage and stored appropriately, then it should be serviced every 10 years from manufacturing date.*

Safety

## Delta Inflatable Lifejacket Belt-Pack, 150N, ISO

- Certified per ISO 12402-3 for ultimate safety while on board
- Auto & manual version
- User-friendly, providing the maximum safety, thanks to its fast inflation ability, even at very low temperatures
- Ideal for all ships, especially the small ones where storage space is limited



**Delta**  
CE 150N  
ISO 12402-3  
**LALIZAS**  
www.lalizas.com



Code	71109	71201
Adult	✓	✓
Manual Inflator	✓	
Automatic Inflator (LALIZAS JS1)		✓



**Combine with**  
LALIZAS Lifejacket  
LED flashing light  
page 23

## Kappa - Theta - Omega - Alpha - Sigma - Delta - Vita

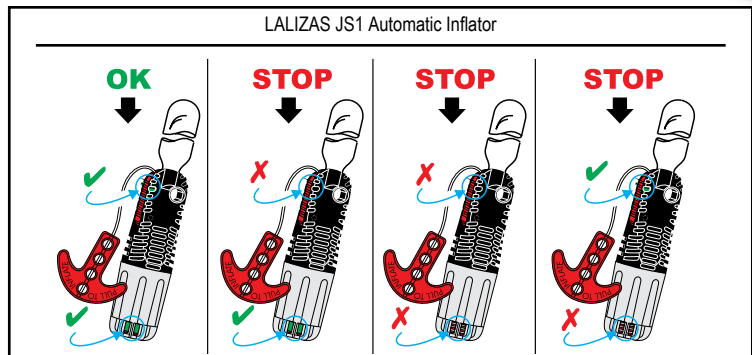
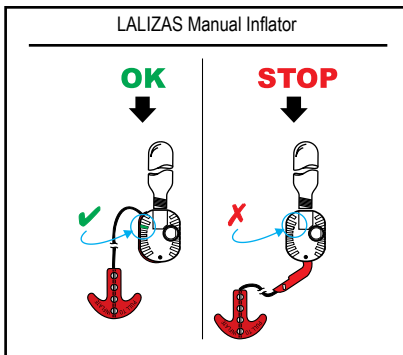

Code | 73582

**Kappa Inflatable Lifejacket, Auto, 180N, with Double Crotch & Harness, ISO, Adult, with Ocean Signal MOB1, Set**



Code | 73583

**Theta Inflatable Lifejacket, Auto, 290N, with Sprayhood, Double Crotch & Harness, ISO, Adult, with Ocean Signal MOB1, Set**



**For more information**

Ocean Signal  
Man Over Board Locator  
Beacon MOB1

page 60



Safety



**For more information**

Ocean Signal  
Man Over Board Locator  
Beacon MOB1

page 60



Code | 73581

**Sigma Inflatable Lifejacket, Auto, 170N, with Plastic Buckle, Harness & Zipper, ISO, Adult, with Ocean Signal MOB1, Set**



Code | 73580

**Sigma Inflatable Lifejacket, Auto, 170N, with Plastic Buckle, ISO, Adult, with Ocean Signal MOB1, Set**



Code | 73650

**Sigma Work Vest, Auto, 170N, ISO, Adult, Orange Durable PVC Fabric Cover, with Ocean Signal MOB1, Set**

**LALIZAS Inflatable Lifejackets Lamda, Auto, 150N, 275N, 330N, SOLAS/MED**

- Certified per SOLAS, for ultimate safety while on board
- Certified according to the specifications of the HSE Compatibility Test Protocol for Lifejackets and Immersion suits on Offshore installations (when combined with LALIZAS Immersion suit with rubber gloves)
- Ideal for use on commercial vessels, offshore platforms and mega yachts (based on the product code you will choose)
- Twin chambers as per SOLAS requirements
- Lamda 330N goes above and beyond the standard regulations of 275N
- It is the only SOLAS lifejacket in its category with two stainless steel buckles, on the center and side of the waist harness, in order to be easily removed even inflated, when needed & features a crotch strap
- Available in one adult size, which can be easily adjusted to passengers with chest size up to 175cm or more, with the use of the LALIZAS Waist Belt Extender (71161)



Front



Back



**LALIZAS Inflatable Lifejacket Lamda, Auto, SOLAS/MED**

Code	71107	71216
Adult	✓	✓
Newton	150	275



**LALIZAS Inflatable Lifejacket Advanced Lamda, Auto, 330N, with Crotch Strap, with/without Sprayhood, SOLAS/MED**

Code	72114	72115
Adult	✓	✓
Newton	330	
Sprayhood*		✓



**Combine with**  
LALIZAS Lifejacket  
LED flashing light  
page 23



72114



72115

\*LALIZAS Sprayhood for SOLAS Inflatable Lifejackets  
Code | 72113

## Inflatable Lifejackets

**LALIZAS** 

Safety

**new**



Code | 73629

**LALIZAS Inflatable Lifejacket Lamda, Auto, 150N, SOLAS/MED, Adult, with Ocean Signal MOB1, Set**



Code | 73584

**LALIZAS Inflatable Lifejacket Lamda, Auto, 275N, SOLAS/MED, Adult, with Ocean Signal MOB1, Set**

**For more information**  
 Ocean Signal  
 Man Over Board Locator  
 Beacon MOB1  
**page 60**



**Delta**  
 150N  
 SOLAS  
**LALIZAS**  
 www.lalizas.com

**LALIZAS Inflatable Lifejacket Belt-Pack Delta, Auto, 150N, SOLAS/MED, Adult**

- Certified per SOLAS, for ultimate safety while on board
- Twin chambers as per SOLAS requirements
- Provides the maximum safety thanks to its fast inflation ability, even at very low temperatures
- Extra user-friendly lifejacket, ideal for saving valuable space on board
- Available in one adult size, which can be easily adjusted to passengers with chest size up to 175cm or more, with the use of the LALIZAS waist belt extender (71161)

Code | 71108



**LALIZAS Inflatable Lifejacket Vacuum Packed, Delta, Auto 150N, SOLAS/MED, Adult with LALIZAS Lifejacket Light, SOLAS/MED**

- Ideal for passenger vessels
- Twin chambers as per SOLAS requirements
- Pre-installed LALIZAS Lifejacket LED Flashing Light "Safelite IV"
- Vacuum packed
- Increased lifespan
- Easy storage

Code | 711081



**Vacuum Packed**

**with LALIZAS Lifejacket Light**



**LALIZAS Sprayhood for ISO Inflatable Lifejackets**

- Suitable for every adult inflatable lifejacket of 150N
- Very easy to use, it is designed to fit over the head & cover the inflated chamber
- Equipped with ventilation holes for easy breathing
- Provided along with donning and storage instructions & sprayhood folding instructions
- Meets the requirements of ISO 12402-8



Suitable for Sigma, Alpha, Kappa & Delta inflatable lifejackets



Code | 72325



Safety

**LALIZAS Sprayhood for SOLAS Inflatable Lifejackets**

- Suitable for SOLAS inflatable lifejackets
- Designed to fit over the head and cover the inflated chamber
- Equipped with small holes to facilitate breathing
- It is not deployed automatically, so it is important to practice using it in advance
- It comes as standard with LALIZAS Infl. Lifejacket Adv. Lamda, Auto, 330N, w/sprayhood & crotch strap, SOLAS/MED (product code: 72115)

Suitable for LALIZAS Lamda & Delta inflatable lifejackets



Code | 72113



Code | 73676

**LALIZAS Auto Re-arm Kit for JS1 Adult Lifejacket, 60gr**



Code | 20190

**LALIZAS Auto Re-arm Kit for JS1 Adult Lifejacket, 33gr**



Code | 20200

**LALIZAS Auto Re-arm Kit for JS1 Child Lifejacket, 24gr**



Code | 71323

**LALIZAS Manual Re-arm Kit for Adult Lifejacket, 33gr**



Code | 71324

**LALIZAS Auto Re-arm Bobines, for Adult & Child Lifejacket, Set of 4**



**LALIZAS Auto Re-arm Mechanism HAMMAR MA1 & Cylinder 33gr**

Code | 71741



**CO<sub>2</sub> Cylinder**

Code	00349	00348	02597	02197
Size (gr)	24	33	38	60



Safety



**Safety Harness ISO**

Available in both adult and child sizes, it features a heavy-duty stainless steel interlocking buckle, a D-ring and a fully adjustable black polyester waist webbing.

Approved per the European standards ISO 12401.

Code	71145	71146
Type	Adult	Child
Chest Size (cm)	70 to 150	60 to 90
Weight (kg)	>50	20-50



**new**



**Safety Harness ISO, with Double Safety Line ISO, Set**

This safety harness comes as set with the LifeLink Double Safety Line of 185 cm in length for extra safety on board. Available in adult & child sizes. The safety harness as well as the safety line are ISO approved.

Code	74570	74571
Type	Adult	Child
Chest Size (cm)	70 to 150	60 to 90
Safety Line Length (cm)	185	
Weight (kg)	>50	20-50

Stainless steel double insured hooks



**LifeLink Safety Lines, ISO**

The LifeLink Safety Lines are available in single, double, double elastic and triple hook configurations and are all approved per ISO 12401. Their double action hook design prevents accidental opening whilst still offering superb single handed operation.



Code | 71147  
**Single, Length 150 cm**

Code | 71148  
**Double, Length 185 cm**

Code | 71149  
**Triple, Length 200 cm**

Code | 71150  
**Double, Elastic, Length 100-180 cm**

Code | 71151  
**LifeLink Hook, ISO**



 **Flameproof**

**LALIZAS Inflatable Lifejacket Protective Work Cover**

- Provides shielding against heat, sparks, flame, soft chemicals
- Easy fit / Simple-to-use design
- Lightweight fabric
- Does not affect the operation, behaviour & water performance of the protected lifejacket

Code | 71211



**Suitable for:**

**Sigma Lifejackets:**  
71096, 71097, 72154, 72560, 72561, 72081 & 720811

**Zeta Lifejackets:**  
72399 & 72400

**Lamda Lifejackets:**  
71107, 71216, 72114 & 72115





Safety

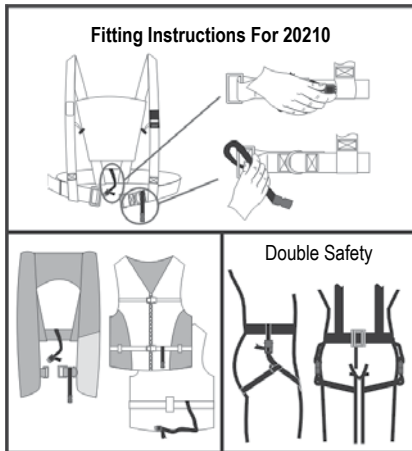

Code | 20210

**Harness & Lifejacket Crotch Strap**

The crotch strap can be used with all LALIZAS lifejackets / buoyancy aids and harnesses.



**LALIZAS Waist Belt Extender for SOLAS Inflatable Lifejackets**

Code | 71161  
Length | 50 cm

**Sea Dye Marker**

- Lifesaving device used for sea rescue, usually requested by Army/Navy
- Contains a fluorescent green dye that spreads over the surface of the water so as to increase visibility for a rescue pilot to see
- Can be easily placed in a life vest pocket or liferaft safety kits or else
- The bright green pattern on the water can be seen for about a mile or 2km and lasts vividly for about 60 minutes
- To use, just tear in the area indicating the marking on the PVC bag



**Main materials**

- PVC bag
- Fluorescent dye, Uranine U, 90gr

Code | 70464

**Maintenance of Inflatable Lifejackets**

**Maintenance-Storage Instructions:** Store the lifejacket in a dry place away from direct sunlight. Don't expose the lifejacket to excessive heat. Do not use as a cushion. Check if the CO<sub>2</sub> cylinder is perforated or damaged. In this case you should replace it. Check the state of the lifejacket (inflatable chamber, buckles, whistles, webbings and harnesses). In case of a severe drop or signs of deterioration contact your local approved service station. LALIZAS spare parts need to be replaced after each use, or 3 years after the manufacturing date. Always check the manufacturing date.

**Servicing Instructions:** Your lifejacket shall be serviced at least every year (and more frequently in case of intensive use)

**Lifetime of the lifejacket:** 10 years of the manufacturing date.

**How to wear an Inflatable Lifejacket**



**How to manually activate an Inflatable Lifejacket**



## Foam Lifejackets



Safety



### Chico Lifejacket 100N, ISO

- Approved to the European standards for 100 Newton lifejackets, ISO 12402-4
- All of its raw materials are tested per ISO 12402-7 and ISO 12402 -8, for higher strength, quality and durability
- Lifejacket's foam distribution helps the child to face upwards, out of the water, providing quick turn in case it is unconscious
- A large flotation collar supports the child's head
- All codes feature a crotch strap for higher safety
- It includes one webbing fastener, LALIZAS Whistle (70010), plastic zip and SOLAS Retroreflective Tapes (70180)
- An end rope with plastic button is fixed at the end of each lifejacket for adjustable wearing
- Improved fit and maximum safety
- The baby (72069) and the child (72070 & 71073) lifejackets feature fabric diaper
- Available in 4 sizes

Code	Type	Weight (kg)	Chest Size (cm)
72069	Baby	3-10	50-60
72070	Child	10-20	60-75
71073		15-30	60-70
71074		30-40	70-80

**LALIZAS**

**CHICO**



72069

### Chico Lifejacket 150N, ISO

- Approved to the European standards for 150 Newton lifejackets, ISO 12402-3
- All of its raw materials are tested per ISO 12402-7 and ISO 12402 -8, for higher strength, quality and durability
- Lifejacket's foam distribution helps the child to face upwards, out of the water, providing quick turn in case it is unconscious
- A large flotation collar supports the child's head
- All codes feature a crotch strap for higher safety
- It includes one webbing fastener, LALIZAS Whistle (70010), plastic zip and SOLAS Retroreflective Tapes (70180)
- An end rope with plastic button is fixed at the end of each lifejacket for adjustable wearing
- Improved fit and maximum safety
- The code 71075 features fabric diaper
- Available in 2 sizes

Code	Type	Weight (kg)	Chest Size (cm)
71075	Child	15-30	60-70
71076		30-40	70-80



**CHICO**



**Combine with**  
LALIZAS Lifejacket  
LED flashing light  
**page 23**



Child



### LALIZAS Lifejacket 100N, ISO

- Approved to the European standards for 100N Lifejackets and ISO 12402-4
- All of its raw materials are tested per ISO 12402-7 and ISO 12402 -8 for higher strength, quality and durability
- Specifically designed to turn the unconscious user on a face-up position on time and to offer support for the head
- A large flotation collar supports the user's head keeping it out of water
- It has a crotch strap for keeping the vest securely when in the water
- It has one webbing fastener, LALIZAS Whistle (70010), plastic zip and SOLAS Retroreflective Tapes (70180)
- An end rope with plastic button is fixed at the end of the lifejacket for adjustable wearing
- Three main options, suitable for infants, children and adults
- The baby (72067) and the child (72068 & 71077) lifejackets feature fabric diapers
- Available in 8 sizes, in fluorescent orange colour

Code	Type	Weight (kg)	Chest Size (cm)
72067	Baby	3-10	50-60
72068	Child	10-20	60-75
71077		15-30	60-70
71078		30-40	70-80
71079	Adult	40-50	80-90
71080		50-70	90-100
71081		70-90	100-120
71082		>90	120-130



72067

72068



**LALIZAS Lifejacket 150N, ISO**

- Approved to the European standards for 150N lifejackets, ISO 12402-3
- All of its raw materials are tested per ISO 12402-7 and ISO 12402-8, for higher strength, quality and durability
- Its design provides the user's turn on time
- A large flotation collar supports the user's head for keeping the head out of water
- It has a crotch strap for keeping the vest securely when in the water
- It has one webbing fastener, LALIZAS Whistle (70010), plastic zip and SOLAS Retroreflective Tapes (70180)
- An end rope with plastic button is fixed at the end of the lifejacket for adjustable wearing
- Provided with a lifting loop for rescue
- Suitable for children and adults
- The child lifejacket 71083 features fabric diapers
- Available in 6 sizes, in fluorescent orange colour



Safety



Child

Combine with  
LALIZAS Lifejacket  
LED flashing light  
page 23



Code	Type	Weight (kg)	Chest Size (cm)
71083	Child	15-30	60-70
71084		30-40	70-80
71085	Adult	40-50	80-90
71086		50-70	90-100
71087		70-90	100-120
71088		>90	120-130



**LALIZAS Lifebelt 100N, ISO**

- Certified per EN ISO 12402-4, EN ISO 12402-7 and EN ISO 12402-9 testing standards according to directive 2016/425/EEC for recreational boats
- Designed for people who may have to wait for rescue, but are likely to do so in sheltered water
- Equipped with a 30mm width waist webbing, 100cm<sup>2</sup> SOLAS Retroreflective Tapes (70180) and LALIZAS Whistle (70010)

Code	Child	Adult
70992	15-40	>40
70991	50-80	80-125



Child

**LALIZAS Lifebelt 150N, ISO**

- Certified per EN ISO 12402-3, EN ISO 12402-7 and EN ISO 12402-9 testing standards according to directive 2016/425/EEC for recreational boats
- Designed for general application or for use with foul weather clothing
- Capable to turn an unconscious person into a safe position
- Requires no subsequent action by the user to maintain this position
- Equipped with a 30mm width waist webbing, 300cm<sup>2</sup> SOLAS Retroreflective Tapes (70180) and LALIZAS Whistle (70010)



Child

Code	Child	Adult
70994	15-40	>40
70993	50/80	80/125



## Lifejackets Dry Bag

- Simple and easy-to-use Lifejackets Dry Bag
- The most "intelligent" and waterproof storage solution for all the necessary safety equipment of your boat
- Made of durable transparent material, without any unnecessary seams
- It meets the minimum space consumption requirements
- It offers the ability of immediate use in case of an emergency or a boat inspection
- Specially designed for storing foam lifejackets of 100N & 150N
- Can safely store all hand and smoke signals required by regulations, in the available space between the lifejackets' neck grooves

Code	Size	Dimensions (cm)	Suitable for LALIZAS lifejackets		
			70991 (100N)	70993 (150N)	70159 (Solus '74)
71220*	1	93x57x36	4	3	5
71221*	2	93x68x36	6	4	7
71222*	3	93x93x36	9	6	10

## Lifejackets Dry Bag with 4 or 6 pcs 70991 (100N), Set

Code	Included	Dimensions (cm)
71223	4pcs 70991 (100N)	60x36x28
71224	6pcs 70991 (100N)	60x36x45



\*Lifejackets not included

## LALIZAS Foam Folding Lifejacket Compact, SOLAS/MED

The series of Compact Folding Lifejackets SOLAS fully complies with the new regulations [IMO Resolutions (MSC.201(81), MSC.216(82), L.S.A. Code as amended by 207(81), 218(82); and MSC 81(70), MSC.200(80), MSC. 226(82), MSC. 323(89), MSC. 368(93) & MSC. 378(93)], which are mandatory for all lifejackets used on board EU flagged vessels.

Driven by regulation changes for lifejacket accessibility on cruise ships, and customer demand for reduced bulk and improved storage options, LALIZAS has designed COMPACT to best service these needs.



Code	72214	72215
Type	Adult	Child
Buoyancy (N)	146	88
Weight (kg)	43-140	15-43



Child



**Combine with**  
LALIZAS Lifejacket LED flashing light  
page 23

### Folding Options

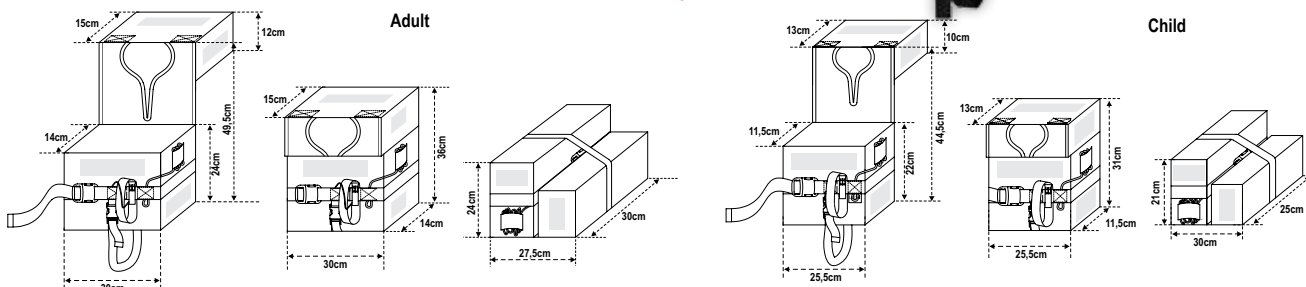



**LALIZAS Foam Lifejacket Advanced, SOLAS/MED**

The series of SOLAS Foam Lifejackets Advanced fully complies with the new regulations [IMO Resolutions (MSC.201(81), MSC.207(81), MSC.200(80), MSC.226(82), MSC.218(82), MSC.216(82), MSC 81(70), MSC. 323(89), MSC. 368(93) & MSC. 378(93)], which are mandatory for all lifejackets used on board EU flagged vessels.

**LALIZAS Foam Lifejacket Advanced, SOLAS/MED**



- Manufactured to equip all commercial vessels under SOLAS/MED
- Features lifting loop and orange buddy line for easy rescue
- Recommended to combine the lifejacket with the compatible LALIZAS Lifejacket LED Flashing Light
- Required on board EU flagged vessels as per regulations

Code	70176
Type	Infant
Weight (kg)	0-15

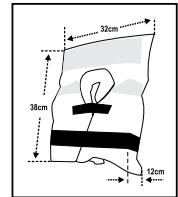

**Combine with**  
LALIZAS Lifejacket  
LED flashing light  
page 23

**LALIZAS Foam Lifejacket Advanced, SOLAS/MED**



- Manufactured to equip all commercial vessels under SOLAS/MED
- Provided with lifting loop and orange buddy line for easier rescue
- Supplied in adult and child sizes
- The adult lifejacket is appropriate for passengers with chest size up to 175cm and overweight passengers
- Recommended to combine the lifejacket with the compatible LALIZAS Lifejacket LED Flashing Light
- Required on board all EU flagged vessels as per regulations

Code	70177	70178
Type	Child	Adult
Weight (kg)	15-43	>43



Child

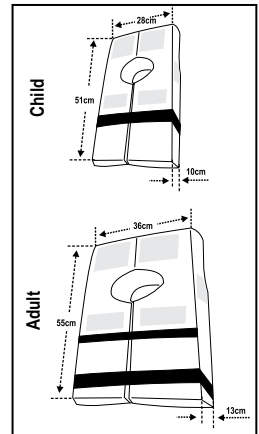

**Features:**



Adjustable strap  
(70176 & 70178)



Comfortable fit around  
the neck



Whistle



Lifting loop



Orange buddy line

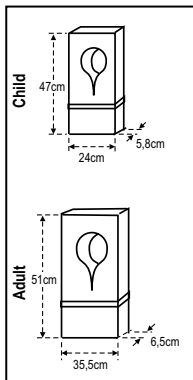

**LALIZAS Foam Lifejacket SOLAS '74**

- Manufactured in accordance with SOLAS '74 requirements
- Commercial grade lifejacket
- Available in adult and child sizes

Code	70157	70159
Type	Child	Adult
Weight (kg)	0-55	>55



Child

## Foam Lifejackets

**LALIZAS**

Safety



CE

### LALIZAS Work Vest 50N, ISO

- Approved to the European standards for 50N buoyancy aids, ISO 12402-5
- All of its raw materials are tested per ISO 12402-7 and ISO 12402-8 for higher strength, quality and durability
- Specifically designed and manufactured for use in the work environment
- It is open on the side areas, being lightweight when wearing it
- Made of special polyester anti-fire fabric
- Its two waist webbings are adjusted by the stainless steel D-rings and hooks
- It comes with SOLAS Retroreflective Tapes (70180)
- It has a fabric pocket for placing tools or other light equipment
- It is available in one adult size and in orange colour

Code	Type	Weight (kg)	Chest Size (cm)
71144	Adult	>40	80-130

### Accessories for the Work Vest



71154



71153



71155

Code	Description
71153	Buckle for 71144, Inox 304, 34x26,5x3mm
71154	D-Ring for 71144, Inox 316, 25x20mm
71155	J Hook for 71144, Nickel plated steel

## Watersports Buoyancy Aids

**LALIZAS**

CE



### Easy Rider Buoyancy Aid 50N, ISO

- Ideal for ski & jet ski
- It covers the waist and back, while it remains comfortable
- It includes one fixed and one adjustable webbing fastener and SOLAS Retroreflective Tapes (70180)
- Approved to the European standards for 50N buoyancy aids, ISO 12402-5
- All of its raw materials are tested per ISO 12402-7 and ISO 12402-8, for higher strength, quality and durability
- Available in 2 sizes, in orange & yellow colour combination

Code	Type	Weight (kg)	Chest Size (cm)
71089	Child	25-40	65-80
71090	Adult	>40	80-130

**easy rider**

CE



### Fit & Float Buoyancy Aid 50N, ISO

- Ideal for ski & jet ski
- It covers the waist and back, while it remains comfortable
- It includes one webbing fastener and plastic zip
- End and top ropes are fixed on the lifejacket for adjustable wearing
- All of its raw materials are tested per ISO 12402-7 and ISO 12402-8 for higher strength, quality and durability

Code	Type	Weight (kg)	Chest Size (cm)
72155	Child	30-50	60-80
72156		50-70	80-100
72157	Adult	70-90	100-130
72158		>90	130-160

**FIT & FLOAT**



**Performance Buoyancy Aid 50N, ISO**

- Ideal for canoe kayak, ski, jet ski & sailing
- Ergonomic design that provides better fit and storage
- It offers a new level of comfort and buoyancy
- Features one waist webbing fastener for total safety, plastic zip and SOLAS Retroreflective Tapes (70180)
- Its reflective silver edging and advanced back neck area complete its design characteristics
- Approved to the European standards for 50N buoyancy aids, ISO 12402-5
- All of its raw materials are tested per ISO 12402-7 and ISO 12402-8, for higher strength, quality and durability
- Available in 4 sizes, in blue & white colour combination

Code	Type	Weight (kg)	Chest Size (cm)
71091	Child	25-40	65-80
71092		40-70	80-100
71093	Adult	>70	100-130
71288		>90	130-160



CE

Safety

**Action Buoyancy Aid 50N, ISO**

- Ideal for ski & jet ski
- Improved design, providing tighter and convenient fit on the wearer
- Dual webbing fasteners for total safety (steady and movable), plastic zip and SOLAS Retroreflective Tapes (70180)
- It offers a new level of comfort and buoyancy
- Its reflective silver edging and advanced back neck area complete its design characteristics
- Approved to the European standards for 50N buoyancy aids, ISO 12402-5
- All of its raw materials are tested per ISO 12402-7 and ISO 12402-8 for higher strength, quality and durability
- Available in 4 sizes, in orange & black colour combination



Code	Type	Weight (kg)	Chest Size (cm)
71060	Child	25-40	65-80
71061		40-70	80-100
71062	Adult	70-90	100-110
71063		>90	110-125



CE

**Slalom Buoyancy Aid 50N, ISO**

- Ideal for ski & jet ski
- Tighter and convenient fitting on the wearer due to its improved design
- It offers a new level of comfort and buoyancy
- Dual webbing fasteners and one top waist webbing fastener for total safety, plastic loop for keys, net holes for removing water and SOLAS Retroreflective Tapes (70180)
- Approved to the European standards for 50N buoyancy aids, ISO 12402-5
- All of its raw materials are tested per ISO 12402-7 and ISO 12402-8, for higher strength, quality and durability
- Available in 4 sizes, in blue & black colour combination



Code	Type	Weight (kg)	Chest Size (cm)
71064	Child	25-40	65-80
71065		40-70	80-100
71066	Adult	70-90	100-110
71067		>90	110-125



CE

## Watersports Buoyancy Aids



Safety



### Neo Buoyancy Aid 50N, ISO

- Ideal for ski & jet ski
- New design, made of neoprene fabric for tighter and stylish fit
- It offers a new level of comfort and buoyancy
- Two webbing moving fasteners for total safety, neoprene outer shell, plastic zip, net holes for removing water and SOLAS Retroreflective Tapes (70180)
- Approved to the European standards for 50N buoyancy aids, ISO 12402-5
- All of its raw materials are tested per ISO 12402-7 and ISO 12402-8 for higher strength, quality and durability
- Available in 5 sizes, in white, red & black colour combination



Code	Type	Weight (kg)	Chest Size (cm)
71068	Child	25-40	65-80
71069		40-50	80-90
71070	Adult	50-70	90-110
71071		70-90	110-120
71072		>90	120-130



### Pro Race Buoyancy Aid 50N, ISO, Adult

- Ideal for ski, jet ski, canoe kayak & sailing
- Designed as the ultimate high performance jacket
- Compact design, ideally suited for dinghy sailors, sport canoeists and windsurfers
- It features high-density soft PVC foam buoyancy, double sided velcro waist straps, side entry zip, a mesh front pocket and SOLAS Retroreflective Tapes (70180)
- The unique double velcro waist strap makes it fully adjustable to a variety of chest size users
- The elastic band shoulders make it to fit younger users
- Approved to the European standards for 50N buoyancy aids, ISO 12402-5
- All of its raw materials are tested per ISO 12402-7 & ISO 12402-8, for higher strength, quality and durability
- Available in 3 sizes in red and orange colour



● Code	71443	71444	71445
● Code	71446	71447	71448
Type	Adult		
Weight (kg)	25-40	40-70	>70
Chest size (cm)	65-80	80-100	100-130



Our unique double velcro waist strap makes the Pro Race series fully adjustable to a variety of chest size users



Pro race buoyancy aid has elastic band shoulders, designed to fit younger users



## Pet Buoyancy Aids



### LALIZAS Pet Retriever Buoyancy Aid

- Foam construction buoyancy aid
- Features strong lifting loop to enable you to retrieve your pet
- Suitable for both dogs and cats
- Available in four sizes from extra small to large

Code	20020	20021	20022	20023
Weight (kg)	< 8	8-15	15-40	> 40
Chest circumference min-max (cm)	25-48	30-60	43-84	46-95







Safety

new



**Comfy Pet Buoyancy Aid**

- Ideal for all water-related activities, offering the extra buoyancy your pet needs
- Lightweight and easily adjustable
- Durable grab handle for secure retrieval aboard
- Storage pocket for multiple uses
- Reflective edging for enhanced visibility
- Available in five sizes, from XS to XL, ensuring that there is one that fits your pet perfectly, being safe and comfortable at the same time

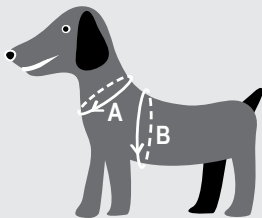

Code	73573	73574	73575	73576	73577
Size	XS	S	M	L	XL
Weight (kg)	up to 5	5-10	10-20	20-40	40-80
A Neckline (cm)	22-34	33-43	40-49	47-60	57-76
B Chest (cm)	25-45	43-63	61-80	77-103	91-113

Lifesaving Lights



**LALIZAS Lifejacket LED Flashing Light "Safelite IV" ON-OFF Water-activated, SOLAS/MED/USCG**

- Water-activated LED flashlight technology
- Extra powerful LED light: Offers lower consumption, longer life and operates automatically when it comes in contact with water
- ON-OFF button operation: To turn it ON-OFF when out of water
- Durable plastic body: 100% Waterproof via ultrasound welding for extra safety
- Universal size clamp: Fits & locks easily in two moves with every 20 - 40 mm lifejacket belt, providing security & stability against sudden moves of panic
- Easy-to-read marking for instant inspection
- Lithium battery: Ensures 5 year lifetime and more than 8 hours of continuous operation. Better performance in extreme weather temperatures

Original Size



Code | 72349



**LALIZAS Lifejacket LED Flashing Light "Safelite IV" ON-OFF Water-activated, SOLAS/MED/USCG**

Code | 723491

Blister



**Hole Puncher for 72348-49 Lights**

Code | 71215



**Base for Lifejacket Flashing Light 72349**

Code | 71214



**Base for Lifejacket Flashing Light 72348**

Code | 72543

Safety

## LALIZAS Lifejacket LED Flashing Light "Alkalite II" ON-OFF Water-activated, SOLAS/MED/USCG

- Water-activated LED flashlight technology
- Extra powerful LED light: Offers lower consumption, longer life and operates automatically when it comes in contact with water
- ON-OFF button operation: To turn it ON-OFF when out of water
- Durable plastic body: 100% Waterproof via ultrasound welding & epoxy resin for extra safety
- Universal size clamp: Fits & locks easily in two moves with every 20 - 50 mm lifejacket belt, providing security & stability against sudden moves of panic
- Easy-to-read marking for instant inspection
- Alkaline battery: Ensures 5 year lifetime and more than 8 hours of continuous operation. Smoother and easier waste batteries management



Code | 72348



## LALIZAS Lifebuoy LED Light STELLA, SOLAS/MED

LALIZAS STELLA Lifebuoy LED Light is a floating light that provides optimum visibility at sea.

### Features of this product in details are:

- SOLAS/MED approved
- Floating lifebuoy light with high-visibility LED light
- Very compact lifebuoy light, low power consumption
- LED-type flashlight, operates with one R20 alkaline battery. 360° arc of visibility
- Dimensions: 160 x 80 x 80 mm
- Weight: 90 gr (without battery)
- Light intensity: 2 cd
- Duration: Approx. 8 hours at 60 flash/minute
- Battery: 1 x R20 battery / D type (not included)
- 3m rope included

Code | 196482



STELLA



Code | 45184

### Clip Holder for STELLA Lifebuoy Light

- Fits any tube or rail, horizontal or vertical Ø 20 to 30 mm
- Screws not included

## LALIZAS Lifebuoy Light M.O.B SOLAS/MED/USCG

LALIZAS offers you optimum visibility at sea with its classic marine product, the Lifebuoy Light M.O.B.

### Specifications

- SOLAS/MED/USCG approved
- Capable of burning continuously with high luminous intensity
- Not less than 2cd in all directions of the upper hemisphere for a period of at least 2h (in white colour)
- To be used with 4 alkaline batteries size D

Code | 70030

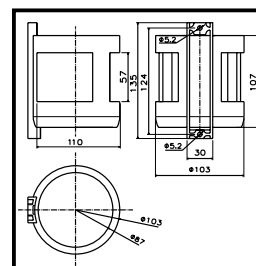
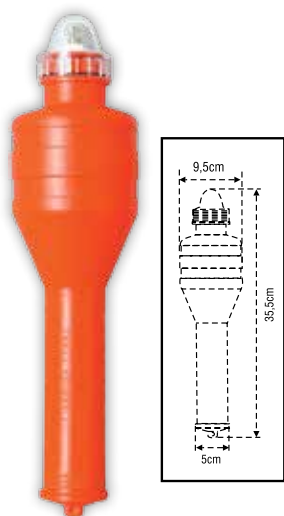

Code | 70000

### LALIZAS Lifebuoy Light Holder

High-quality black polycarbonate lifebuoy light holder. Designed to hold the light vertically in the 'off' position and to provide easy removal in emergencies.

### Rail Mount for Lifebuoy Light



Code | 20581

### Spring Clip



Code | 50530



### LALIZAS Lifebuoy Light SOLAS/MED/USCG

LALIZAS Lifebuoy Light uses flashing light with LED technology and is designed to withstand the toughest rigours of the commercial and offshore sectors. It is completely watertight with a compact structure and designed to be tamper proof, corrosion resistant and to deliver, as a minimum standard, an omnidirectional over 2cd output for at least 2 hours.

**Specifications**

- SOLAS/MED/USCG approved
- Five-year lifetime
- No maintenance or replacement batteries are required
- Supplied complete with bracket & 1 m Lifebuoy Lanyard
- Compact size
- Mounting bracket with easy fitting in all locations
- Advanced LED technology for low consumption and enhanced reliability



Code | 71325



### LALIZAS Lifebuoy Light SOLAS/MED/USCG - ATEX/IECEx

LALIZAS Lifebuoy Light uses flashing light with LED technology and is designed to withstand the toughest rigours of the commercial and offshore sectors. It is completely watertight with a compact structure and designed to be tamper proof, corrosion resistant and to deliver, as a minimum standard, an omnidirectional over 2cd output for at least 2 hours. It is specifically designed to be highly resistant to accidental damage on board. Meeting full SOLAS and EC MED approvals, it is also approved to both ATEX and IECEx standards making it the only choice for hazardous installations such as offshore oil rigs, gas and oil tankers (for use in hazardous zones 0,1 and 2).

**Specifications**

- SOLAS/MED/USCG approved
- ATEX & IECEx Intrinsically Safe Approvals
- Intrinsically safe, for use in all potentially explosive zones
- Five-year lifetime
- No maintenance or replacement batteries are required
- Supplied complete with bracket & 1 m lifebuoy lanyard
- Compact size
- Mounting bracket with easy fitting in all locations
- Advanced LED technology for low consumption and enhanced reliability

Code | 71326



The holding base of 71325 & 71326 can be self-mounted or combined with the support bases of the "Store-All" cases



Rail Support Base for "Store-All" Cases - Graphite

Fixed Mount Support Base for "Store-All" Cases - Graphite



### MOB Systems



### LALIZAS Encapsulated Lifebuoy Rescue Line, 30 m

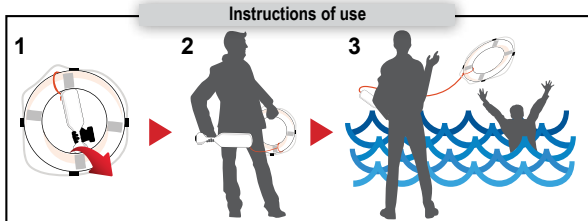
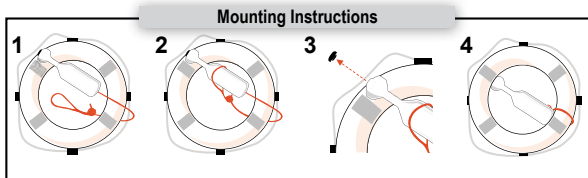

- 30 m lifeline in plastic tube, which fits in LALIZAS lifebuoys
- Material: UV resistant polyethylene
- Dimensions: L 480 x W 130 x H 80 mm
- Weight: 950 gr
- Rope: Ø 8 mm, length 30 m
- Lifeline Breaking Load: 500 kg
- Compliance with SOLAS requirements

Code | 72190





Safety



**Ext. Diameter:**  
Ø 720 mm ± 10 mm  
**Int. Diameter:**  
Ø 440 mm ± 10 mm  
**Height:**  
105 mm ± 10 mm

**LALIZAS Lifebuoy Ring, with SOLAS Retroreflective Tape**

Designed for pleasure and commercial usage, features an orange, rack hard, cross - linked polyethylene outer shell that will not deteriorate and is unaffected by extreme weather conditions.

Code	70090	70110
Approval	SOLAS/MED	
Weight (kg)	2.5	4
Drop Height (m)	80	



Code	700901	701101
Approval	USCG	
Weight (kg)	2.5	4
Drop Height (m)	80	

**Plastic Holder for Lifebuoy Ring, Set of 3pcs**

Code | 01107



**GIOVE**

**LALIZAS Lifebuoy Ring GIOVE, SOLAS/MED**

- With 4 Retroreflective Tapes SOLAS (70180) & 3 m grabline
- Polyethylene outer structure, filled with polyurethane foam
- Stowage height: Anywhere up to 30 m above the waterline



Code	Ø ext. (cm)	Ø int. (cm)	Height (cm)	Weight (kg)	Buoyancy (N)
38158	63	41	12	2.5	144

**SATURNO Lifebuoy Ring, Non-SOLAS**

- Polyethylene structure
- Fitted with a 3m grabline

**SATURNO**



**Holder for Lifebuoy Ring & Light**

- Glass-reinforced plastic
- Fits easily on any rail Ø 18-25 mm



Code | 45185

Code	Description	Ø ext. (cm)	Ø int. (cm)	Height (cm)	Weight (kg)	Buoyancy (N)
44666	Filled with polyurethane foam	57	35	9	1,3	88
12010	No foam-filling	57	35	9	0,9	91



Safety



**Clip-on Lifebuoy Support, for Rail Ø25-28mm, White**

Code | 197763



Height: 85cm  
Width: 85cm  
Depth: 20cm

**LALIZAS Lifebuoy Ring Case with Ring (70090) & 30 m Floating Rope**

Code | 71285

**LALIZAS Deck Pole Base for Lifebuoy Ring Case**

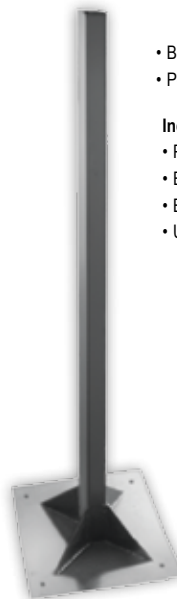

- Base Dimensions: 30x30cm
- Pole Height: 150cm

**Includes:**

- Pole base (1 pc)
- Expand bolts (4 pcs)
- Bolt & nut (1 pc)
- U bolts & nuts (2 pcs)

Code | 71286

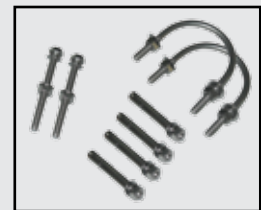
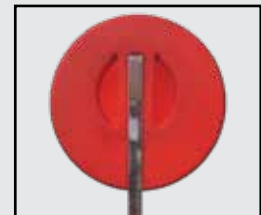

Mounting Kit Included

**LALIZAS Lifebuoy Ring SOLAS 75cm, Lifebuoy Light 71325, 30m Rope, Grey Case, Set**

**The Set includes:**

- 1 Lifebuoy Ring (code 70090)
- 1 Lifebuoy Light (code 71325)
- 30m Floating Rope, Ø 8mm
- 1 case (code 72345)

Code | 72077

\*Lifebuoy Light 70030 (not included) can also fit into the case

**Case for Set Lifebuoy Ring SOLAS 75cm, Lifebuoy Light 71325, 30m Rope Grey**

Code | 72345



**Lifebuoy Ring Container Standard**

Dimensions: 84 x 108 x 31 cm (H x W x Depth)



Code | 40212

Please note that the container is supplied empty. A lifebuoy ring must be ordered separately.

**Container with Door for Lifebuoy Ring Ø 60 or 75 cm**

It features a transparent round opening to check the presence of the lifebuoy.  
Dimensions: 90 x 90 x 22 cm (H x W x Depth)



Code | 196992

Please note that the container is supplied empty. A lifebuoy ring must be ordered separately.

**Accessories for mounting**

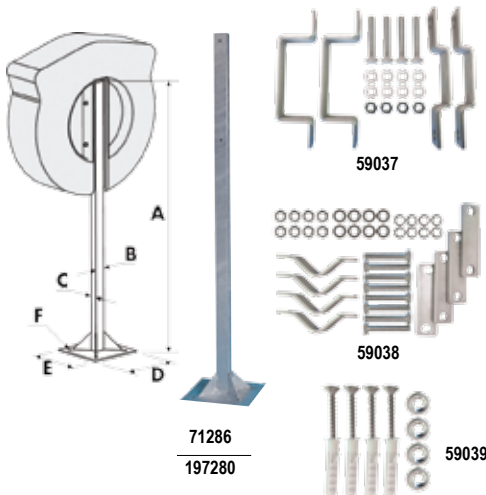

Description	Pole Kit for lifebuoy container		Mounting kit for rail	Wall mounting kit (bolts + screws)
	Pole	Mounting Kit For Pole		
For standard container model	71286		59038	59039
For container with door	197280	59037		

Code	Model	A (cm)	B (cm)	C (cm)	D (cm)	E (cm)	F (base hole diameter)
71286	Standard container	150	5,8	3,8	30	30	Ø 1,5 cm
197280	Container with door	200	10	5	30	30	2,5 x 1,4 cm (oblong hole)



**Mooring Ring with 30m Rope Ø4mm**

Designed for the retrieval of MOB, the ring is moulded in PVC, weighing only 250gr and it is tied to a 30m floating rope.

Ext. Diam.: 166 mm  
Int. Diam.: 110 mm

Code | 20693



**Lifebuoy Ring, No 45 with Rope**

- Int.Diam. 210mm
- Ext.Diam. 420mm

Code | 63219

**Mooring Ring, Ø166**

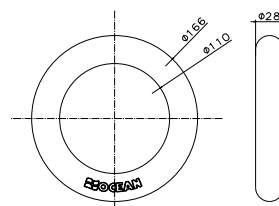

Code | 72449



### Horseshoe Lifebuoy "Basic I", 140N

- Offers personal floatation to seafarers in case of man overboard emergency
- Essential equipment for all boats, both yachts and motorboats
- Features a flexible zipper cover and a plastic clip fastening
- Simple to use
- Three different colours: white, yellow and orange

Code	20530	20540	20550
Colour	Orange	White	Yellow



### Horseshoe Lifebuoy "Quick RD", 142N

- Made of polyester with PVC backing
- Waterproof, its fabric doesn't fade
- Highly resistant to UV radiation
- Features a flexible zipper cover and plastic hook fastening

**For storing this lifebuoy:**

You can use the Horseshoe Bracket (20580), where the Lifebuoy Light M.O.B (70030) can be also mounted, while the "Quick Fit" Horseshoe Cases (70018 & 70019) are ideal for its storage.

Code	70162	70164	70165
Colour	Yellow	Orange	White



### Horseshoe Lifebuoy Case with "Quick RD" Orange (70164), Lifebuoy Light (71325) & 30 m Rope, Grey

**The Set Includes:**

- 1 Horseshoe Lifebuoy "Quick RD" (code 70164)
- 1 Lifebuoy Light (code 71325)
- 30 m floating rope, Ø 8 mm, orange
- 1 horseshoe case (code 72330)

\*Lifebuoy Light 70030 (not included) can also fit into the case

Code | 72078



### Horseshoe Case for "Quick RD", Grey

Code | 72330



### Horseshoe Case "Quick Fit" for "Basic I"

- Suitable for storing the "Basic I" Horseshoe Lifebuoy
- Made of polyester fabric, with PVC backing
- Waterproof, protecting the lifebuoy from any weather conditions
- Features a quick velcro open - close system and straps for mounting the case on your boat's rails
- Its design allows you to store the lifebuoy light as well
- Available in white & yellow colour



Code	70018	70019
Colour	White	Yellow

### Horseshoe Bracket, Inox

- Can be easily installed on any kind of vessel
- Its fixing system allows horseshoe and lifebuoy light to be easily removed in case of emergency



Code | 20580

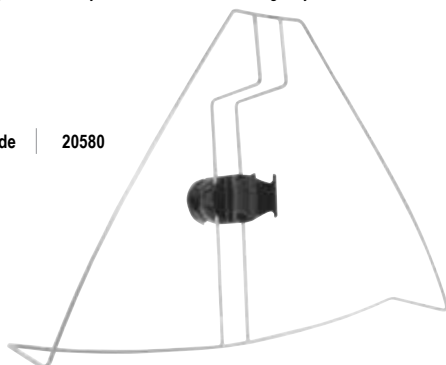

Code | 20707

### Holder for Ring or Horseshoe Lifebuoy

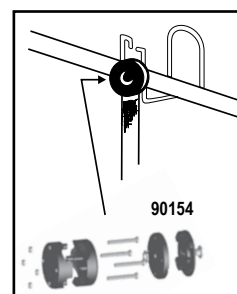

\* The set of connector & rail mounts 90154 is not included



### Holder for Lifebuoy Ring/Horseshoe & Lifebuoy Light

- Ideal for placing and storing your lifebuoy ring or horseshoe
- It comes with a plastic holder, which makes it really easy to mount it on your boat's rails
- Made of stainless steel
- Comes with a small elastic stretch cord for keeping the ring or lifebuoy steady on the holder
- You can also store the lifebuoy light, since it features plastic clips on the base of the holder

Code | 95733



Code | 20581

### Rail Mount for Lifebuoy Light



### Connector, Parallel, for Fender Baskets, 2 pcs

Code | 90163



### Connector & Rail Support for Fender Baskets, Set

Code | 90154



### CABO Floating Line, Orange

Material: Polyethylene

Code	Diameter (mm)	Length (m)	Strength (kg)
94801	6	30	320
70260	8	30	400



### CABO Floating Rope, Orange

Material: Polyethylene

Code	Diameter (mm)	Length (m)	Strength (kg)
98991*	6	200	100
98992*	8	200	260
98993*	10	200	310

\* Sold by linear meter







**LifeLink Rescue Sling**

- Used for MOB retrieval
- Designed to be permanently mounted onto the pushpit in its own soft, easy-to-clean PVC bag
- The kit contains 36 m of floating line attached to a sturdy buoyant PVC life-sling and a personal retaining clip for added safety
- Deployment is achieved by removing the LifeLink, attaching the floating line to a secure point and throwing it towards the man overboard

- Once in the water, the boat should circle the casualty allowing the LifeLink to be towed to their aid
- Rescue is completed when the casualty is safely clipped into the LifeLink winched to the boat and hauled on board
- Available in white and yellow colour



**Contents:**

- Rail mounted PVC stowage bag
- 36m floating line
- LifeLink with webbing strap

**Features:**

- Breaking strain of line > 200 kg
- Breaking strain of flotation belt > 700 kg



Code	20440	73670
Colour	Yellow	White

**Meets ISAF regulation**

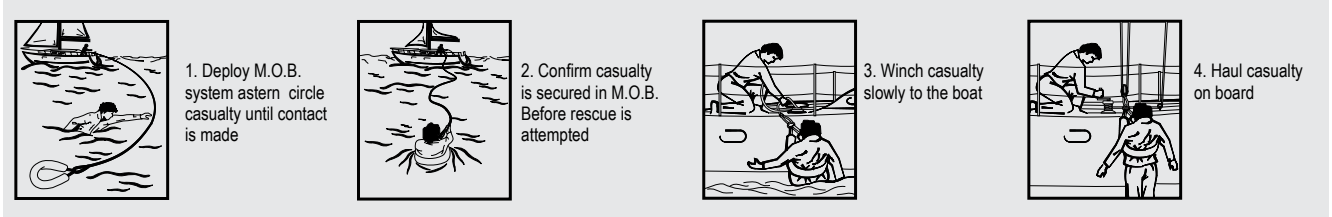

**LifeLink Throwing Line, with 23m Rope**

- Ideal for sailing, boating, canoeing, rafting and getting a line ashore
- Can be used either in hand or attached onto the rail for MOB retrieval
- Comes in a high visibility yellow bag with 23 m of floating line
- The smallest of the LifeLink MOB appliances offers maximum flexibility for storage
- Quick and easy to deploy
- Featuring a hand loop on top & an attachment loop at ends, it enables both the rescuer and casualty to be connected
- User instructions are printed on the reverse side of the bag
- The deployment loop has a PVC cover which aids grip and allows easy and quick rescue if required
- Can be used as a standard throwing sock or attached to the rail deployed and towed behind the vessel whilst circling the casualty



Code | 71682

**Meets ISAF regulation**

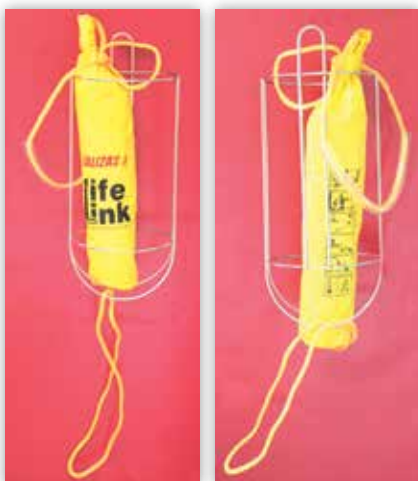

\*Attention, the product is provided without the stainless steel bracket.

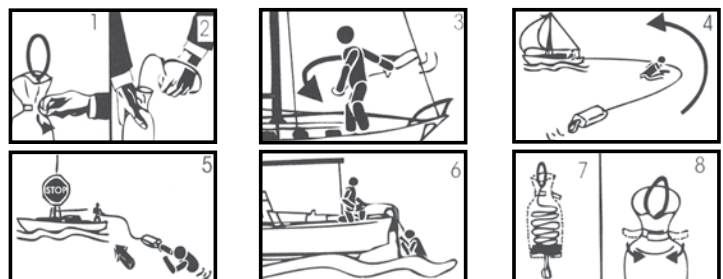

Safety

**Flushmount Safety Ladder**

- It helps any crewmember get back easily on board without external help
- Suitable for frequent use (during your vacations) or in case of Man Over Board
- It consists of 3 polypropylene steps and 1 stainless steel handle assembled by a highly resistant line (bright yellow polyester of Ø 3mm)
- It is stored in a polyamide tube with a grey polypropylene cap, for optimum protection and waterproofness
- The Man Over Board removes the cap, pulls the ladder down and climb on board
- Lightweight
- Easily flushmounted (like a thru-hull fitting)
- Transom or skirt mount (sail and power boats), just above waterline

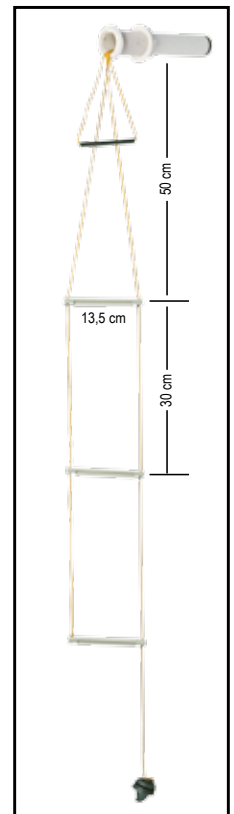
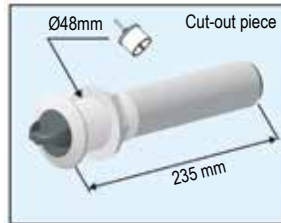

Code | 51558



**Safety Ladder "Safe Up", M.O.B, 5 steps**

- A must-have MOB safety equipment for your boat
- Provides instant aid to an overboard crewmember in getting back on board
- The overboard crewmember only needs to grab & pull the handle in order to unfold instantly the fabric ladder and climb back on board safely
- It features 3 loops that can be fastened firmly on the rail of a boat and can be placed overboard
- When unfolded, it provides 5 steps with a steady foothold for the user to climb on board easily
- Lightweight
- Waterproof
- Made of durable fabric in order to withstand sunlight and harsh sea environment
- It can be repacked easily

- Dimensions when folded: Width 38 cm - Height 20 cm
- Dimensions when unfolded: Width 38 cm - Height 185 cm
- Case Fabric: 500D PVC & Polyester
- Webbing: Strong Polyester
- Weight limit: 507lbs (230kg)



Code | 71684

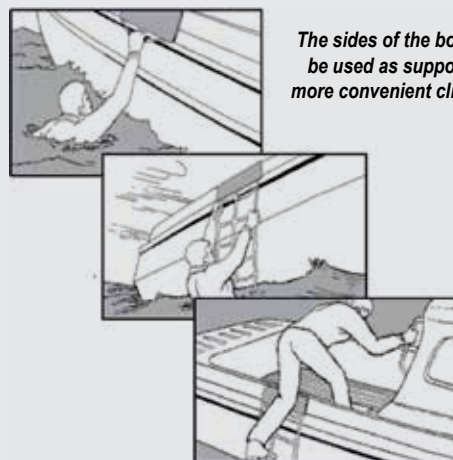
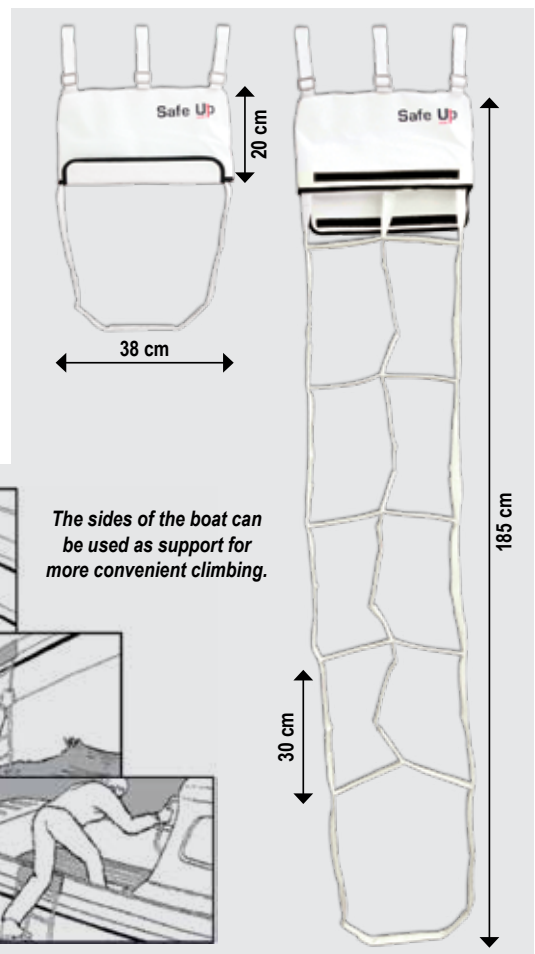

*The sides of the boat can be used as support for more convenient climbing.*



Safety

**new**

**LifeLink MOB Danbuoy & Horseshoe, Grey**

- The MOB items are automatically inflated after release & coming into contact with water
- Saving valuable stowage space
- Easy-to-fit MOB
- Rapid deployment in case of emergency
- Material HDPE with UV protection
- All metal components are stainless steel
- Created via rotomolding
- Distance between horizontal rails: 300 – 310 mm

**Includes:**

- An HDPE durable case
- High visible inflatable Danbuoy assembled with LALIZAS Lifejacket LED Flashing Light water-activated "Safelite IV" SOLAS/MED/USCG
- High visible inflatable Horseshoe with LALIZAS Whistle (70010)
- Drogue
- The stainless steel parts for its placement onto boat rails



Made in EU

Code | 73669

**Mounting on the rails**

**Conforms to the ISAF Offshore Special Regulations**

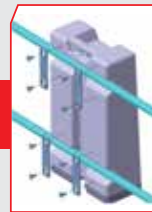

2 horizontal rails

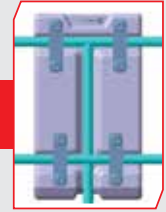
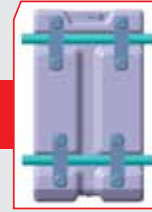

Intersection of 2 horizontal rails with a vertical one

Service required after each use or 3 years after the manufacturing date by an authorised LALIZAS service station.



**CE**

Certified EN361

Code | 71152

**Vestype Safety Harness, with D-ring**



**LifeLink Safety Jacklines, Set (2 pcs)**

- Provides you safety while on board without hindering your freedom of movement to a great extent
- Made of 25mm durable, UV-resistant polyester strap
- Features two loops to attach it to the boat
- Available in white colour and five sizes from 6m to 10m

Code	20702	20703	20704	20705	20706
Length (m)	6	7	8	9	10
Width (mm)	25				
Colour	White				



**new**

**Lifeguard Rescue Can, with Polyurethane Foam, Orange**



Code | 74371

- Designed for rescue at sea
- Made of high-density polyethylene (HDPE)
- Internal filling with polyurethane foam for higher buoyancy
- Features cotton strap and polyethylene rope
- Buoyancy: >150N

- Dimensions: (L x W x H): 68 x 24,5 x 14cm
- Maximum load: 150kg



Safety



## Lifesaving Apparatus

- For use on sail or motor boats
- Outer cover made of high strength polyethylene with an inner polystyrene filling
- Complete with all-round rope lifeline
- Available in 4, 8 and 12 person models
- High visibility orange
- Approved to EEP. Approval number: 4232/46/00

Code	70131	70133	70135
Persons	4	8	12
Volume (lit.)	80	151	252
Weight (kg)	5	11	18
A (cm)	55	76	100
B (cm)	55	76	100
C (cm)	25	25	25

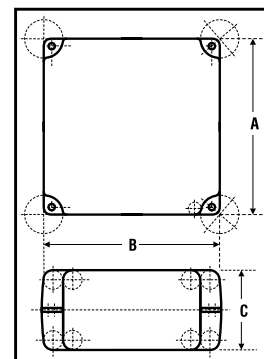

## Lifesaving Apparatus "Cushion Type"

- For use on sail or motor boats
- Made of a durable nylon outer shell and inner layers of polyethylene
- Complete with all round rope (lifeline)
- Lightweight
- Can be used as a seat cushion
- Available in 3,4 and 6 person models
- High visibility orange
- Approved to EEP. Approval number: 4232/24/01

Code	70270	70271	70272
Persons	3	4	6
A (cm)	40	52	46
B (cm)	50	47	70
C (cm)	29	25	36

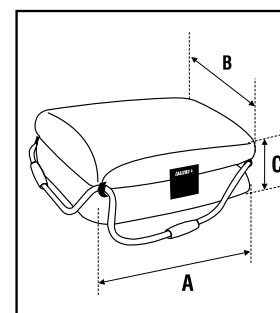

## DELFINO Life float Foam filled with Retroreflective Tape

- It provides efficient buoyancy in case of shipwreck or Man Overboard, allowing the casualties to gather for easier survival and rescue
- Made of indestructible plastic material
- High density polyethylene, filled with polyurethane foam for buoyancy
- Fitted with retroreflective tape for added visibility
- Braided rope is reeved through reinforced eyelets at regular intervals (2, 3 or 4 eyelets on each side) to account for a larger number of persons grasping the rope

Code	Persons	Length (mm)	Width (mm)	Height (mm)	Weight (kg)
195392	4	900	900	280	16
195393	8	900	900	280	16
195394	12	980	980	300	23

Approved by the Italian Merchant Marine

Made in Italy

# Sea Anchors-Drogues

## Sea Anchor (Drogue)

- Designed to reduce the speed of the ship, slow down the drift, stabilize the hull, reduce the swing frequency, and effectively reduce the water drift effect of the hull
- Suitable for power boats, sail boats, inflatable boat, jet skis, kayaks as sea brake or sea anchor
- Ideal for fishing

- PVC strong coated with continuous inside webbing for added strength and durability
- Easy to deploy and to retrieve, without tangling and spinning
- With portable and compact design, it dries quickly and stores compactly
- Weighted bottom and automatic opening
- Available in 5 sizes
- Packed with harness buoy

Code	Boat Length	A(cm)	B(cm)	C(cm)	D(cm)
10071	4,5m (15ft)	50	55	8	64
10072	6m (20ft)	65	75	10	70
10073	7,5m (25ft)	125	125	17	125
10074	9m (30ft)	135	142	20	125
10075	13,5m (45ft)	190	145	20	130

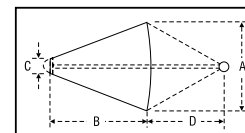

**ATTENTION:** This is a very general guide and there may be variations based on the weight & keel of the boat, or even on the intended use of the sea anchor etc. Your choice should not be based only on the guide.



**Professional Sea Anchor (Drogue)**

- Especially designed for use on large boats and under harsh conditions
- The fabric is 200D polyester coated on both sides with 0,45 mm PVC
- It is immensely strong using 40mm, UV-resistant webbing terminating on a 6 mm x 60 mm Inox connecting ring
- All drogues are supplied in a hardy and durable yellow safety storage bag
- Available in different sizes

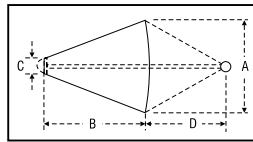

**ATTENTION:** This is a very general guide and there may be variations based on the weight & keel of the boat, or even on the intended use of the sea anchor etc. Your choice should not be based only on the guide.



Safety

Code	Boat Length	A(cm)	B(cm)	C(cm)	D(cm)
10240	15m (49ft)	200	165	20	160
10241	18m (59ft)	250	210	25	200
10242	21m (69ft)	300	250	30	240

**Retroreflective Tapes**

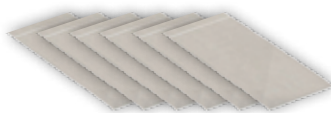

**Retroreflective Tapes ORALITE , SOLAS, 5 x 10cm, Set (6pcs)**

Retroreflective tape retail pack to SOLAS (L.S.A Code). Six 10cmx5cm self-adhesive strips per pack. May be sewn.

Code | 70190

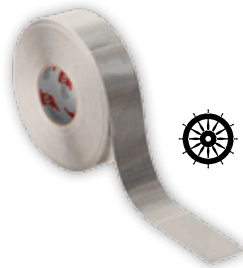

**Retroreflective Tape ORALITE, SOLAS & USCG, 40m Roll**

- High performance micro prismatic tape
- Permanently marked with ships wheel logo for immediate compliance identification
- Single layer construction for durability, abrasion resistance and flexibility
- No risk of water penetration
- Complies with SOLAS and the IMO LSA Code
- Tested in accordance with IMO Resolution A.658 (16) for Type I applications
- Approved by the US Coast Guard and Bureau Veritas
- Vinyl construction designed for inflatable devices and use in harsh maritime environments
- Length 40 m, width 50mm

Code | 70180

**Immersion Suits**



**LALIZAS Immersion Suit "Neptune", Insulated, SOLAS/MED**



- Exceeds the latest SOLAS specifications for hypothermia protection
- Ideal for use on board ferries, offshore drilling rigs, rescue boats, man-overboard boats and for general commercial use
- Protects you in situations where the danger of hypothermia is great, increasing your chances of survival
- Made of reinforced neoprene material (5mm thickness)
- Ergonomic design
- Thermally insulated
- Diesel, oil & flame resistant
- Successfully submitted to water ingress, jump & leak tests
- Easy & quick donning
- Should be worn in conjunction with an approved lifejacket

**Features:**

- A face seal and flap
- 3-finger gloves
- Front waterproof zipper ankle cuffs
- Neoprene pocket
- SOLAS Retroreflective Tapes (70180)



\* With rubber gloves

**LALIZAS Immersion Suit "Neptune", Insulated, with Rubber Gloves, SOLAS/MED\***

Code	72746	70457	72747
Size	Small	Universal Size	XLarge
Height Range (cm)	140-160	160-190	190-210
Weight Range (kg)	40-80	55-95	85-130

**LALIZAS Immersion Suit "Neptune", Insulated, with Neoprene Gloves, SOLAS/MED**

Code	72745	70454	70455
Size	Small	Universal Size	XLarge
Height Range (cm)	140-160	160-190	190-210
Weight Range (kg)	40-80	55-95	85-130

## Immersion Suits

**LALIZAS** 

Safety



### LALIZAS Inspection Device for Immersion Suit

The aluminium kit contains a set of Servicing Equipment:

- Face fixture (2 pcs)
- Pressure gauge (0-6kPa)
- Foot pump (with multi-valve adaptor)
- Glue and applicator (2 pcs)
- Neoprene patches

MSC /Circ./1047, MSC /Circ. 1114

Code | 70168

## Liferafts

**LALIZAS** 

new



Made in Italy

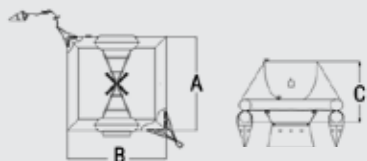

### LALIZAS ISO ATLANTIC C Liferaft >24h

LALIZAS ISO ATLANTIC C Liferaft >24h is designed for survival for more than 24 hours. Ideal for offshore sailing with complete survival equipment. Certified according to ISO 9650-1 A testing standard. ISO 9650-1 defines liferafts designed for long voyages or cruises when gusts of wind can be expected, together with exceptional wave height (excluding abnormal conditions such as hurricanes). Each liferaft contains thermal floor, internal & external light, pop-up tent and 4 stabilising pockets.

Available in 4 to 12 person versions, packed either in a canister or in a waterproof valise. Designed to inflate in an outdoor temperature of -15°C to +65°C. The inspection interval depends on the flag, while after 10 years it is recommended every year.

#### Equipment:

1. Sea anchor with rope (1 piece)
2. Life ring with rope (1 piece)
3. Floating paddles (2 pieces)
4. Immediate action (1 piece)
5. Floating knife (1 piece)
6. Canopy support (2 pieces)
7. Bailer (1 piece)
8. Sponge (2 pieces)
9. Whistle (1 piece)
10. Repair kit (1 piece)
11. Manual pump (1 piece)
12. User internal manual (1 piece)
13. Seasickness bag (12 pieces)
14. Torch kit (2 pieces)
15. Red hand flares (6 pieces)
16. Red parachute flares (2 pieces)
17. Signaling mirror (1 piece)
18. Drinking water (1,5 L per person)
19. Food per person (10.000 Kcal per person)
20. Anti-seasickness pills (6 per person)
21. First aid kit (1 piece – ISO)
22. Thermal protective aids (2 pieces)





















Canister



Valise

Model	Dimensions (mm)		
	A	B	C
LALIZAS ISO ATLANTIC C 4	1940	2040	1240
LALIZAS ISO ATLANTIC C 6	1940	2040	1240
LALIZAS ISO ATLANTIC C 8	1940	3110	1240
LALIZAS ISO ATLANTIC C 10	1990	3760	1340
LALIZAS ISO ATLANTIC C 12	1990	3760	1340

Code									
Code	501538	501543	501548	501552	501555	501519	501524	501530	501534
Code									
Persons	4	6	8	10	12	4	6	8	10
Packaging	Canister					Valise			
Total Weight (kg)	47	51	61	79	82	44	48	57	72
Length (mm)	720	720	730	850	850	680	680	710	770
Width (mm)	460	460	470	600	600	340	340	330	440
Height (mm)	320	320	330	330	330	420	420	450	470

\*Please note that all liferafts' dimensions and weight may slightly vary ( ±3 cm for dimensions, ±5% for weight)



Safety

new



Made in Italy



### LALIZAS ISO ATLANTIC PG Liferaft >24H, Grab Bag

LALIZAS ISO ATLANTIC PG Liferaft >24 Grab Bag is supplied with an approved grab bag to reduce weight and dimensions, designed for survival more than 24 hours. Certified according to ISO 9650-1 A testing standard. ISO 9650-1 defines liferafts designed for long voyages or cruises when gusts of wind can be expected, together with exceptional wave height (excluding abnormal conditions such as hurricanes). It is available in 4 to 12 person versions, packed either in a canister or in a waterproof valise. Each life raft contains thermal floor, internal and external light, pop-up tent and 4 stabilizing pockets. Designed to inflate in an outdoor temperature of -15°C to +65°C while its inspection interval is every 3 years.

**Equipment:**

- 1. Sea anchor with rope (1 piece)
- 2. Life ring with rope (1 piece)
- 3. Floating paddles (2 pieces)
- 4. Immediate action (1 piece)
- 5. Floating knife (1 piece)
- 6. Canopy support (2 pieces)
- 7. Bailer (1 piece)
- 8. Sponge (2 pieces)
- 9. Whistle (1 piece)
- 10. Repair kit (1 piece)
- 11. Manual pump (1 piece)
- 12. User internal manual (1 piece)
- 13. Torch kit (2 pieces)
- 14. Red hand flares (3 pieces)
- 15. Red parachute flares (1 piece)
- 16. Signaling mirror (1 piece)
- 17. Drinking water (0,5 L per person)
- 18. Anti-seasickness pills (6 per person)

**Grab bag Equipment:**

- 1. Seasickness bag (8 pieces)
- 2. Red hand flares (3 pieces)
- 3. Red parachute flares (1 piece)
- 4. Drinking water (1 L per person)
- 5. Food (10.000 Kcal per person)
- 6. First aid kit (1 piece)
- 7. Thermal protective aids (2 pieces)



Canister



Valise



Model	Dimensions (mm)		
	A	B	C
LALIZAS ISO ATLANTIC PG 4	1940	2040	1240
LALIZAS ISO ATLANTIC PG 6	1940	2040	1240
LALIZAS ISO ATLANTIC PG 8	1940	3110	1240
LALIZAS ISO ATLANTIC PG 10	1990	3760	1340
LALIZAS ISO ATLANTIC PG 12	1990	3760	1340

Code	501541	501546	501551	501556	501559	501522	501528	501533	501536
Persons	4	6	8	10	12	4	6	8	10
Packaging	Canister					Valise			
Total Weight (kg)	37	38	45	60	61	34	35	42	53
Length (mm)	660	660	720	850	850	640	640	650	760
Width (mm)	420	420	460	600	600	270	270	320	360
Height (mm)	280	280	320	290	290	400	400	390	450



new



Made in Italy



### ARIMAR OCEANUS PG Liferaft IT, Grab Bag

ARIMAR OCEANUS PG Liferaft IT is ideal for ships flying the Italian flag and for navigation without limits. It is supplied with an approved grab bag to reduce weight and dimensions. It has been certified according to according to the Italian legislation Zattera riconosciuta equivalente al DM 219/2002 and ISO 9650:2005 (Type 1 - Group A). ISO 9650 clearly states the performance level and technical specifications of the liferaft and materials used in its construction. It is available in 4 to 12 person versions, packed either in a canister or in a waterproof valise. Each life raft contains thermal floor, internal and external light, pop-up tent and 4 stabilizing pockets. ARIMAR OCEANUS PG WITH GRAB BAG Life raft is designed to inflate in an outdoor temperature of -15°C to +65°C while its inspection interval is every 2 years.

**Equipment**

- 1. Sea anchor with rope (1 piece)
- 2. Life ring with rope (1 piece)
- 3. Floating paddles (2 pieces)
- 4. Immediate action (1 piece)
- 5. Floating knife (1 piece)
- 6. Canopy support (2 pieces)
- 7. Bailer (1 piece)
- 8. Sponge (2 pieces)
- 9. Whistle (1 piece)
- 10. Repair kit (1 piece)
- 11. Manual pump (1 piece)
- 12. User internal manual (1 piece)
- 13. Seasickness bag (12 pieces)
- 14. Torch kit (1 piece)
- 15. Red hand flares (3 pieces)
- 16. Red parachute flares (1 piece)
- 17. Signaling mirror (1 piece)
- 18. Drinking water (0,5 L per person)
- 19. Anti-seasickness pills (6 per person)

**Grab bag Equipment**

- 1. Seasickness bag (8 pieces)
- 2. Red hand flares (1 piece)
- 3. Red parachute flares (1 piece)
- 4. Floating smoke signal (2 pieces)
- 5. Drinking water (1 L per person)
- 6. Food (10.000 Kcal per person)
- 7. First aid kit (1 piece)
- 8. Thermal protective aids (2 pieces)
- 9. Fishing kit (1 piece)



Canister



Valise

Model	Dimensions (mm)		
	A	B	C
ARIMAR OCEANUS PG 4	1940	2040	1240
ARIMAR OCEANUS PG 6	1940	2040	1240
ARIMAR OCEANUS PG 8	1940	3110	1240
ARIMAR OCEANUS PG 10	1990	3760	1340
ARIMAR OCEANUS PG 12	1990	3760	1340

Code	500642	500644	500647	500005	500651	500654	500657	500661	500662
Persons	4	6	8	10	12	4	6	8	10
Packaging	Canister					Valise			
Total Weight (kg)	37	38	45	60	61	34	35	42	53
Length (mm)	660	660	720	850	850	640	640	650	760
Width (mm)	420	420	460	600	600	270	270	320	360
Height (mm)	280	280	320	290	290	400	400	390	450

\*Please note that all liferaft dimensions and weight may slightly vary (±3 cm for dimensions, ±5% for weight)

**new**



Made in Italy

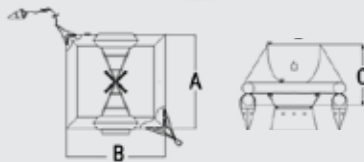

Model	Dimensions (mm)		
	A	B	C
LALIZAS ISO ATLANTIC P 4	1940	2040	1240
LALIZAS ISO ATLANTIC P 6	1940	2040	1240
LALIZAS ISO ATLANTIC P 8	1940	3110	1240
LALIZAS ISO ATLANTIC P 10	1990	3760	1340
LALIZAS ISO ATLANTIC P 12	1990	3760	1340

## LALIZAS ISO ATLANTIC P Liferaft FR <24

LALIZAS ISO ATLANTIC P Liferaft FR <24h is ideal for offshore sailing characterised by a complete "PLUS" survival kit. Certified according to ISO 9650-1 A testing standard. ISO 9650-1 defines life rafts designed for long voyages or cruises when gusts of wind can be expected, together with exceptional wave height (excluding abnormal conditions such as hurricanes).

It is available in 4 to 12 person versions, packed either in a canister or in a waterproof valise. Each liferaft contains thermal floor, internal and external light, pop-up tent and 4 stabilizing pockets. Designed to inflate in an outdoor temperature of -15°C to +65°C while its inspection interval is every 3 years.

### Equipment

- Sea anchor with rope (1 piece)
- Life ring with rope (1 piece)
- Floating paddles (2 pieces)
- Immediate action (1 piece)
- Floating knife (1 piece)
- Canopy support (2 pieces)
- Bailer (1 piece)
- Sponge (2 pieces)
- Whistle (1 piece)
- Repair kit (1 piece)
- Manual pump (1 piece)
- User internal manual (1 piece)
- Seasickness bag (12 pieces)
- Torch kit (2 pieces)
- Red hand flares (3 pieces)
- Red parachute flares (2 pieces)
- Signaling mirror (1 piece)
- Drinking water (0,5 L per person)
- Anti-seasickness pills (6 per person)



Canister



Valise



Code		501540	501545	501550	501553	501557	501521	501527	501532	501535
<b>Persons</b>		<b>4</b>	<b>6</b>	<b>8</b>	<b>10</b>	<b>12</b>	<b>4</b>	<b>6</b>	<b>8</b>	<b>10</b>
<b>Packaging</b>		<b>Canister</b>				<b>Valise</b>				
<b>Total Weight (kg)</b>		37	38	45	60	61	34	35	42	53
<b>Length (mm)</b>		660	660	720	850	850	640	640	650	760
<b>Width (mm)</b>		420	420	460	600	600	270	270	320	360
<b>Height (mm)</b>		280	280	320	290	290	400	400	390	450

**new**



Made in Italy

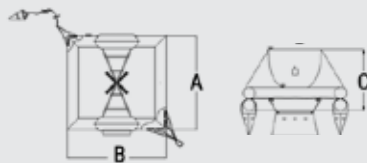

Model	Dimensions (mm)		
	A	B	C
ARIMAR OCEANUS 4	1940	2040	1240
ARIMAR OCEANUS 6	1940	2040	1240
ARIMAR OCEANUS 8	1940	3110	1240
ARIMAR OCEANUS 10	1990	3760	1340
ARIMAR OCEANUS 12	1990	3760	1340

## ARIMAR OCEANUS Liferaft IT

ARIMAR OCEANUS Liferaft IT is ideal for ships flying the Italian flag and for navigation without limits. It is updated, having reduced weight by 17% and lower dimensions by 10% than the old model. It has been certified according to the Italian legislation DM 12/08/2002 n. 219. It is available in 4 to 12 person versions, packed either in a canister or in a waterproof valise. Each liferaft contains thermal floor, internal and external light, pop-up tent and 4 stabilizing pockets. ARIMAR OCEANUS Liferaft is designed to inflate in an outdoor temperature of -15°C to +65°C while its inspection interval is every 2 years.

### Equipment

- Sea anchor with rope (1 piece)
- Life ring with rope (1 piece)
- Floating paddles (2 pieces)
- Immediate action (1 piece)
- Floating knife (1 piece)
- Canopy support (2 pieces)
- Bailer (1 piece)
- Sponge (2 pieces)
- Whistle (1 piece)
- Repair kit (1 piece)
- Manual pump (1 piece)
- User internal manual (1 piece)
- Seasickness bag (12 pieces)
- Torch kit (1 piece)
- Red hand flares (4 pieces)
- Red parachute (2 pieces)
- Floating smoke signal (2 pieces)
- Signaling mirror (1 piece)
- Drinking water (1,5 L per person)
- Food (10.000 Kcal per person)
- Anti-seasickness pills (6 per person)
- First aid kit (1 piece – ISO)
- Thermal protective aids (2 pieces)
- Fishing kit (1 piece)



Canister



Valise



Code		500641	500408	500409	500649	500004	500653	500656	500660	500410
<b>Persons</b>		<b>4</b>	<b>6</b>	<b>8</b>	<b>10</b>	<b>12</b>	<b>4</b>	<b>6</b>	<b>8</b>	<b>10</b>
<b>Packaging</b>		<b>Canister</b>				<b>Valise</b>				
<b>Total Weight (kg)</b>		47	51	61	79	82	44	48	57	72
<b>Length (mm)</b>		720	720	730	850	850	700	700	710	77
<b>Width (mm)</b>		460	460	470	600	600	300	300	330	440
<b>Height (mm)</b>		320	320	330	320	330	430	430	450	470

\*Please note that all liferaft dimensions and weight may slightly vary ( ±3 cm for dimensions, ±5% for weight)





**new**



Made in Italy

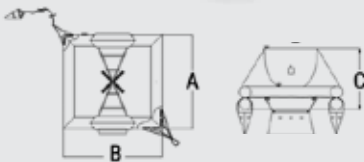

Model	Dimensions (mm)		
	A	B	C
LALIZAS ISO ATLANTIC L 4	1940	2040	1240
LALIZAS ISO ATLANTIC L 6	1940	2040	1240
LALIZAS ISO ATLANTIC L 8	1940	3110	1240
LALIZAS ISO ATLANTIC L 10	1990	3760	1340
LALIZAS ISO ATLANTIC L 12	1990	3760	1340

**LALIZAS ISO ATLANTIC L Liferaft <24 (HR & Int.)**

LALIZAS ISO ATLANTIC L Liferaft <24h is ideal for offshore sailing with limited survival equipment. Certified according to ISO 9650-1 A testing standard. ISO 9650-1 defines liferafts designed for long voyages or cruises when gusts of wind can be expected, together with exceptional wave height (excluding abnormal conditions such as hurricanes). Each liferaft contains thermal floor, internal & external light, pop-up tent and 4 stabilising pockets.

Available in 4 to 12 person versions, packed either in a canister or in a waterproof valise. Designed to inflate in an outdoor temperature of -15°C to +65°C. The inspection interval depends on the flag, while after 10 years it is recommended every year.



**Equipment**

1. Sea anchor with rope (1 piece)
2. Life ring with rope (1 piece)
3. Floating paddles (2 pieces)
4. Immediate action (1 piece)
5. Floating knife (1 piece)
6. Canopy support (2 pieces)
7. Bailer (1 piece)
8. Sponge (2 pieces)
9. Whistle (1 piece)
10. Repair kit (1 piece)
11. Manual pump (1 piece)
12. User internal manual (1 piece)
13. Seasickness bag (12 pieces)
14. Torch kit (1 piece)
15. Red hand flares (3 pieces)
16. Red parachute flares (2 pieces)
17. Signaling mirror (1 piece)
18. Anti-seasickness pills (6 per person)



Canister

Valise

Code		501539	501544	501549	501554	501558	501520	501526	501531	501560	
Code		501481	501483	501484	501479	501480	501482	501478	501474	501476	
Persons		4	6	8	10	12	4	6	8	10	
Packaging		Canister					Valise				
Total Weight (kg)		35	35	41	55	55	32	32	38	48	
Length (mm)		660	660	720	850	850	640	640	650	760	
Width (mm)		420	420	460	600	600	270	270	320	360	
Height (mm)		280	280	320	290	290	400	400	390	450	

**new**



Made in Italy

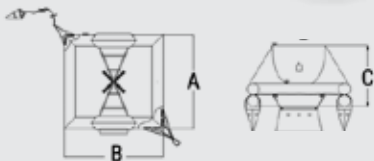

Model	Dimensions (mm)		
	A	B	C
LALIZAS SEAWORLD PB 4	1940	2040	1240
LALIZAS SEAWORLD PB 6	1940	2040	1240
LALIZAS SEAWORLD PB 8	1940	3110	1240
LALIZAS SEAWORLD PB 10	1990	3760	1340
LALIZAS SEAWORLD PB 12	1990	3760	1340

**LALIZAS SEAWORLD Liferaft PB GR**

LALIZAS SEAWORLD Liferaft PB GR is extremely light and compact, ideal for yachts and small ships. It is manufactured according to the standards in Greece and it is equipped with a First Aid Kit approved by the Greek Ministry. It is available in 4 to 12 person versions, packed either in a canister or in a waterproof valise. Designed to inflate in an outdoor temperature of 0°C to +65°C while its inspection interval is every year.

**Equipment**

1. Sea anchor with rope (1 piece)
2. Life ring with rope (1 piece)
3. Floating paddles (2 pieces)
4. Immediate action (1 piece)
5. Knife (1 piece)
6. Canopy support (2 pieces)
7. Bailer (1 piece)
8. Sponge (2 pieces)
9. Whistle (1 piece)
10. Repair kit (1 piece)
11. Manual pump (1 piece)
12. User internal manual (1 piece)
13. Seasickness bag (12 pieces)
14. Torch kit (1 piece)
15. Red hand flares (4 pieces)
16. Red parachute flares (2 pieces)
17. Drinking water (0,3 L per person)
18. First aid kit (1 piece)
19. Signaling table (1 piece)



Canister



Valise

Code		501491	501493	501495	501497	501499	501501	501502	501504	501506	501508
Persons		4	6	8	10	12	4	6	8	10	12
Packaging		Canister					Valise				
Total Weight (kg)		34	35	39	50	51,5	25	25,5	29	48	49
Length (mm)		680	680	720	730	730	660	660	660	720	720
Width (mm)		420	420	460	470	470	280	280	330	360	360
Height (mm)		280	280	320	330	330	350	350	400	400	400

\*Please note that all liferaft dimensions and weight may slightly vary (±3 cm for dimensions, ±5% for weight)



Safety



## LALIZAS ISO RACING Liferaft, <24h

LALIZAS ISO RACING high-quality standard liferaft is ultra-light, having a compact size which provides easy storage. Due to the lightweight material, it is ideal for racing sailboats that need to save space and weight. Its manufacturing technology and materials are inspired by the aviation industry to ensure maximum performance. Available in sizes for 4 - 12 persons, packed either in a canister or in a waterproof valise.

It is automatically inflated by a 12-metre painter line and its inflation system provides enough gas to inflate all the buoyancy chambers. Each chamber is capable of fully supporting the raft with its maximum number of occupants. LALIZAS ISO RACING is manufactured and tested according to ISO 9650-1 standards as last amended for Safety and offers highly visible, stable and sheltered conditions for the occupants.



**Ultra Lightweight**

Approved by BV & MMF

Made in EU

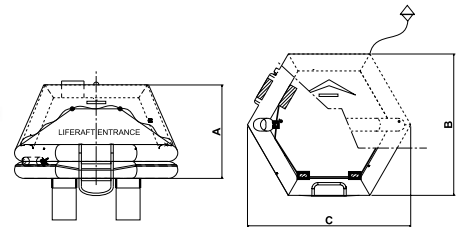

Model	Dimensions (mm)		
	A	B	C
ISO RACING 4	1170	1770	2044
ISO RACING 6	1200	2090	2413
ISO RACING 8	1250	2385	2755
ISO RACING 10	1300	2615	3020
ISO RACING 12	1350	2850	3291



Canister



Valise

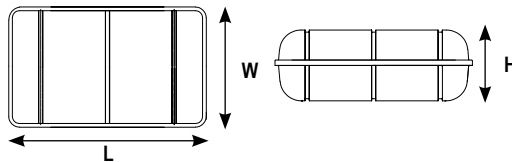

Code	72371	72372	72373	72374	72375
Code	723711*	723721*	723731*	723741*	723751*
Persons	4	6	8	10	12
Packaging	Canister				
Total Weight (kg)	29	32	36	42	45
L (mm)	680	695	695	841	841
W (mm)	480	495	495	551	551
H (mm)	240	252	252	302	302

### Features & Specifications

1. Thermally insulated floor
2. International orange, self erecting canopy with retro-reflective tapes
3. Twin independent buoyancy tubes containing safety valves
4. Rain water collection gutter
5. Ventilation and observation port
6. Fully closeable entrance flap, (the 10 to 12 person versions also include an additional entrance)
7. External, internal lifelines and righting device suitable for handling even by one person
8. Comprehensive international service centers
9. Operating temperature -15° C to +65° C
10. Stowage max height: 6m above sea level

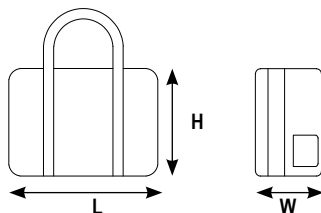

Code	72376	72377	72378	72379
Code	723761*	723771*	723781*	723791*
Persons	4	6	8	10
Packaging	Valise			
Total Weight (kg)	27	30	34	38
L (mm)	630	630	680	740
W (mm)	250	250	300	340
H (mm)	420	420	430	470

### Standard Equipment

1. Portable buoyant bailer (1pc)
2. Sponge (2pcs)
3. Pair of buoyant paddles (1pc)
4. Whistle (1pc)
5. Waterproof torch /bulb (2pcs)
6. Signalling mirror (1pc)
7. Anti-seasickness pills/per person (6pcs)
8. Seasickness bag/per person (1pc)
9. Red hand flare (in accordance with SOLAS LSA Code Chapter III, 3.2) (3pcs)
10. Red parachute flares (in accordance with SOLAS LSA Code Chapter III, 3.1) (2pcs)
11. Repair kit (1pc)
12. Bellow (1pc)
13. Operational Manual (1pc)
14. Table of the life-saving signals (1pc)
15. Log Book + Immediate actions Card (1pc)
16. Mooring Ring with 30m rope (1pc)
17. Safety knife connected to the liferaft, buoyant, fixed blade, rounded tips (1pc)
18. Floating anchor with 30m rope (1pc)



\*Please note that all liferaft dimensions and weight may slightly vary ( ±3 cm for dimensions, ±5% for weight)



**LALIZAS ISO-RAFT International Liferaft**

LALIZAS ISO-RAFT can be used on recreational boats and is certified according to ISO 9650-1 testing standard for Safety and offers highly visible, stable and sheltered conditions for the occupants. This testing standard has been adopted by the most European Countries. This liferaft is available in 4 to 12 person versions, fitted with a single floor as standard and designed to be extremely safe. The ISO-RAFT combines compact size and structural integrity with proven liferaft design. It is automatically inflated by a 12-meter painter line and its inflation system provides enough gas to inflate all the buoyancy chambers. The main body of the life raft consists of two buoyant chambers inflated through a non-return valve ensuring the flotation of the liferaft.

Each chamber is capable of fully supporting the raft with its maximum number of occupants. It can be packed either in a canister or in a waterproof valise. It is initially certified by Polish Register of Shipping-1463 and furthermore approved by the Maritime Authority of the Country of Destination in case it is needed.



Safety

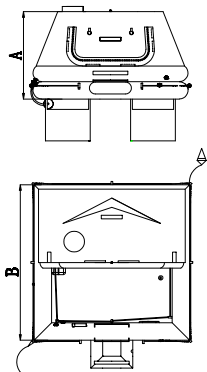

Model	Dimensions (mm)	
	A	B
ISO-RAFT 4	1170	1634
ISO-RAFT 6	1200	1956
ISO-RAFT 8	1250	2224
ISO-RAFT 10	1300	2458
ISO-RAFT 12	1350	2667



Canister



Valise

**Features & Specifications**

1. Thermally insulated floor
2. International orange, self erecting canopy with retro-reflective tapes
3. Twin independent buoyancy tubes containing safety valves
4. Rain water collection gutter
5. Ventilation and observation port
6. Fully closeable entrance flap with zip tape. The 10 to 12 person versions also include an additional entrance.
7. External, internal lifelines and righting device suitable for handling even by one person
8. Comprehensive international service centers
9. Operating temperature -15° C to + 65° C
10. Stowage max height: 6m above sea level

**Standard Equipment**

1. Portable buoyant bailer (1pc)
2. Sponge (2pcs)
3. Pair of buoyant paddles (1pc)
4. Whistle (1pc)
5. Waterproof torch /separate battery /bulb (1pc)
6. Signalling mirror (1pc)
7. Anti-seasickness pills/per person (6pcs)
8. Seasickness bag/per person (1pc)
9. Red hand flare (in accordance with SOLAS LSA Code Chapter III, 3.2) (3pcs)
10. Red parachute flares (in accordance with SOLAS LSA Code Chapter III, 3.1) (2pcs)
11. Repair kit (1pc)
12. Bellow (1pc)
13. Operational Manual (1pc)
14. Table of the life-saving signals (1pc)
15. Log Book + Immediate actions Card (1pc)
16. Mooring Ring with 30m rope (1pc)
17. Safety knife connected to the liferaft, buoyant, fixed blade, rounded tips (1pc)
18. Floating anchor with 30m rope (1pc)

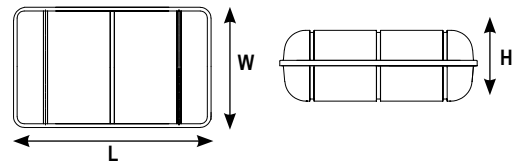

Code	78800	78810	78820	78830	78840
Persons	4	6	8	10	12
Packaging	Canister				
Total Weight (kg)	38	42	50	56	62
L (mm)	760	760	770	820	920
W (mm)	480	480	550	570	570
H (mm)	330	330	345	355	340

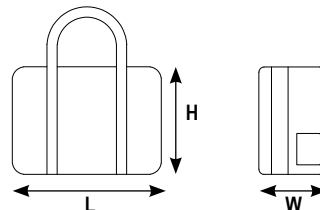

Code	78850	78860	78870	78880
Persons	4	6	8	10
Packaging	Valise			
Total Weight (kg)	32	36	38	45
L (mm)	680	710	710	800
W (mm)	250	280	280	300
H (mm)	400	420	420	470

\*Please note that all liferaft dimensions and weight may slightly vary ( ±3 cm for dimensions, ±5% for weight)

**new**



Made in Italy



Canister



Valise

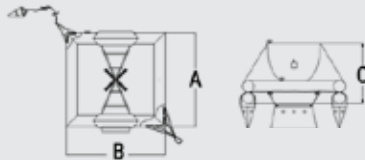

**LALIZAS SEAWORLD Liferaft PB**

LALIZAS SEAWORLD Liferaft PB is ideal for coastal navigation in countries where there is no specific legislation. It is available in 4 to 12 person versions, packed either in a canister or in a waterproof valise. It comes with equipment of complete version. Designed to inflate in an outdoor temperature of 0°C to +65°C while its inspection interval is every 3 years.

**Equipment**

1. Sea anchor with rope (1 piece)
2. Life ring with rope (1 piece)
3. Floating paddles (2 pieces)
4. Immediate action (1 piece)
5. Floating knife (1 piece)
6. Canopy support (2 pieces)
7. Bailer (1 piece)
8. Sponge (2 pieces)
9. Whistle (1 piece)
10. Repair kit (1 piece)
11. Manual pump (1 piece)
12. User internal manual (1 piece)
13. Seasickness bag (12 pieces)
14. Torch kit (1 piece)
15. Red hand flares (3 pieces)
16. Drinking water (0,5 L per person)
17. Anti-seasickness pills (6 per person)
18. First aid kit (1 piece – Leisure)

Model	Dimensions (mm)		
	A	B	C
LALIZAS SEAWORLD PB 4	1940	2040	1240
LALIZAS SEAWORLD PB 6	1940	2040	1240
LALIZAS SEAWORLD PB 8	1940	3110	1240
LALIZAS SEAWORLD PB 10	1990	3760	1340
LALIZAS SEAWORLD PB 12	1990	3760	1340

Code	501575	501576	501577	501578	501579	501571	501572	501573	501574	
Persons	4	6	8	10	12	4	6	8	10	
Packaging	Canister					Valise				
Total Weight (kg)	29	30	35	50	51,5	27	28	32	48	
Length (mm)	660	660	660	740	740	660	660	640	690	
Width (mm)	420	420	420	470	470	280	280	270	370	
Height (mm)	280	280	280	330	330	350	350	400	420	

**new**



Made in Italy

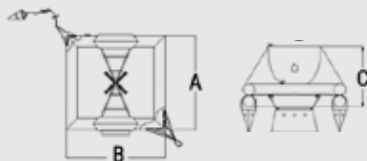

**ARIMAR ISO LUSO Liferaft PT**

ARIMAR LUSO Liferaft PT is ideal for ships flying the Portuguese flag and has been certified according to ISO 9650-1 testing standard. ISO 9650-1 defines liferafts designed for long voyages or cruises when gusts of wind can be expected, together with exceptional wave height (excluding abnormal conditions such as hurricanes). It is ideal for recreational boats, having quick opening thanks to its pop-up tent. It is available in 4 to 12 person versions, packed either in a canister or in a waterproof valise. It is designed to inflate in an outdoor temperature of -15°C to +65°C while its inspection interval is every 3 years.

**Equipment**

1. Sea anchor with rope (1 piece)
2. Life ring with rope (1 piece)
3. Floating paddles (2 pieces)
4. Immediate action (1 piece)
5. Floating knife (1 piece)
6. Canopy support (2 pieces)
7. Bailer (1 piece)
8. Sponge (2 pieces)
9. Whistle (1 piece)
10. Repair kit (1 piece)
11. Manual pump (1 piece)
12. User internal manual (1 piece)
13. Seasickness bag (12 pieces)
14. Torch kit (1 piece)
15. Red hand flares (3 pieces)
16. Red parachute flares (2 pieces)
17. Signaling mirror (1 piece)
18. Anti-seasickness pills (6 per person)



Canister



Valise



Model	Dimensions (mm)		
	A	B	C
ARIMAR ISO LUSO 4	1940	2040	1240
ARIMAR ISO LUSO 6	1940	2040	1240
ARIMAR ISO LUSO 8	1940	3110	1240
ARIMAR ISO LUSO 10	1990	3760	1340
ARIMAR ISO LUSO 12	1990	3760	1340

Code	500720	500721	500722	500723	500724	500725	500726	500727	500728	
Persons	4	6	8	10	12	4	6	8	10	
Packaging	Canister					Valise				
Total Weight (kg)	36	37	43	60	61	32	32	38	53	
Length (mm)	660	660	720	850	850	640	640	650	760	
Width (mm)	420	420	450	600	600	270	270	320	360	
Height (mm)	280	280	310	290	290	400	400	390	450	

\*Please note that all liferaft dimensions and weight may slightly vary ( ±3 cm for dimensions, ±5% for weight)



Safety

new



Made in Italy

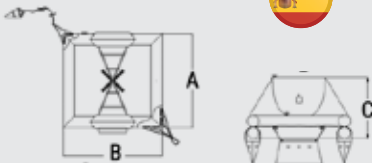

### ARIMAR OPEN SEA Liferaft ESP

ARIMAR Liferaft OPEN SEA ESP has been certified according to ISO 9650-1 A testing standard. ISO 9650-1 defines liferafts designed for long voyages or cruises when gusts of wind can be expected, together with exceptional wave height (excluding abnormal conditions such as hurricanes). It is ideal for ships flying the Spanish flag and for navigation within 60 miles while it complies with category B, zone II and III. It is also approved by the Minister of Development of Spain while its equipment is SOLAS B-pack. It is available in 4 to 12 person versions, packed either in a canister or in a waterproof valise. ARIMAR Liferaft OPEN SEA ESP is designed to inflate in an outdoor temperature of -15°C to +65°C while its inspection interval is every year.

#### Equipment

1. Sea anchor with rope (1 piece)
2. Life ring with rope (1 piece)
3. Floating paddles (2 pieces)
4. Immediate action (1 piece)
5. Floating knife (1 piece)
6. Canopy support (2 pieces)
7. Bailer (1 piece)
8. Sponge (2 pieces)
9. Whistle (1 piece)
10. Repair kit (1 piece)
11. Manual pump (1 piece)
12. User internal manual (1 piece)
13. Seasickness bag (12 pieces)
14. Torch kit (1 piece)
15. Red hand flares (3 pieces)
16. Red parachute flares (2 pieces)
17. Floating smoke signal (1 piece)
18. Signaling mirror (1 piece)
19. Anti-seasickness pills (6 per person)
20. First aid kit (1 piece – SOLAS)
21. Thermal protective aids (2 pieces)
22. Radar reflector (1 piece)
23. Radar reflector support (1 piece)
24. Sea anchor (1 piece) 2
25. Signaling table (1 piece)
26. Drinking water vessel (1 piece)



Canister



Valise

Model	Dimensions (mm)		
	A	B	C
ARIMAR OPEN SEA 4	1940	2040	1240
ARIMAR OPEN SEA 6	1940	2040	1240
ARIMAR OPEN SEA 8	1940	3110	1240
ARIMAR OPEN SEA 10	2550	2550	1410
ARIMAR OPEN SEA 12	2690	2690	1490

Code	500640	500643	500646	500608	500763	500652	50783	500659	500766
Persons	4	6	8	10	12	4	6	8	10
Packaging	Canister					Valise			
Total Weight (kg)	38	38	46	63	73	35	35	42.5	60
Length (mm)	720	720	730	730	850	660	660	730	760
Width (mm)	460	460	470	470	600	330	330	330	360
Height (mm)	320	320	330	390	320	400	400	470	540



new



Made in Italy

### LALIZAS SEAWORLD Liferaft LB

LALIZAS SEAWORLD Liferaft LB is ideal for coastal navigation in countries where there is no specific legislation. It is available in 4 to 12 person versions, packed either in a canister or in a waterproof valise, and comes with equipment of lightened version. Designed to inflate in an outdoor temperature of 0°C to +65°C while its inspection interval is every 3 years.

#### Equipment

1. Sea anchor with rope (1 piece)
2. Life ring with rope (1 piece)
3. Floating paddles (2 pieces)
4. Immediate action (1 piece)
5. Knife (1 piece)
6. Bailer (1 piece)
7. Sponge (2 pieces)
8. Whistle (1 piece)
9. Repair kit (1 piece)
10. Manual pump (1 piece)
11. User internal manual (1 piece)
12. Seasickness bag (12 pieces)
13. Torch kit (1 piece)

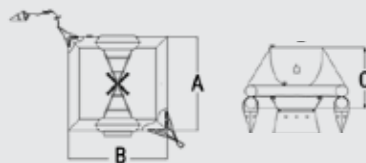

Model	Dimensions (mm)		
	A	B	C
LALIZAS SEAWORLD LB 4	1940	2040	1240
LALIZAS SEAWORLD LB 6	1940	2040	1240
LALIZAS SEAWORLD LB 8	1940	3110	1240
LALIZAS SEAWORLD LB 10	1990	3760	1340
LALIZAS SEAWORLD LB 12	1990	3760	1340



Canister



Valise

Code	501566	501567	501568	501569	501570	501561	501562	501563	501564	501565
Persons	4	6	8	10	12	4	6	8	10	12
Packaging	Canister					Valise				
Total Weight (kg)	29	29	30	51,5	51,5	26	26	27	40	40
Length (mm)	660	660	660	750	750	660	660	660	660	660
Width (mm)	420	420	420	480	480	280	280	280	330	330
Height (mm)	280	280	280	330	330	350	350	350	400	400

\*Please note that all liferaft dimensions and weight may slightly vary ( ±3 cm for dimensions, ±5% for weight)

**new**



Made in Italy

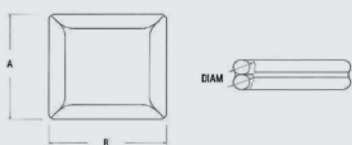

Model	Dimensions (mm)		
	A	B	DIAM
LALIZAS EUROPE II INSHORE 4	1440	1440	220
LALIZAS EUROPE II INSHORE 6	1700	1700	240
LALIZAS EUROPE II INSHORE P 8	1940	1940	260

## LALIZAS EUROPE II INSHORE Liferaft (FR & HR)

LALIZAS EUROPE II INSHORE Liferaft can be used on recreational boats and has been certified according to ISO 9650-2 testing standard. ISO 9650-2 defines life rafts designed for sailing in areas where moderate conditions are expected, such as coastal waters, bays, estuaries, rivers and lakes. It is available in 4 to 8 person versions, packed either in a canister or in a waterproof valise. LALIZAS EUROPE II INSHORE Life raft is designed to inflate in an outdoor temperature of 0°C to +65°C. The inspection interval depends on the flag, while after 10 years it is recommended every year.

### Equipment

1. Sea anchor with rope (1 piece)
2. Life ring with rope (1 piece)
3. Floating paddles (2 pieces)
4. Immediate action (1 piece)
5. Floating knife (1 piece)
6. Canopy support (2 pieces)
7. Bailer (1 piece)
8. Sponge (2 pieces)
9. Whistle (1 piece)
10. Repair kit (1 piece)
11. Manual pump (1 piece)
12. User internal manual (1 piece)
13. Seasickness bag (12 pieces)
14. Torch kit (1 piece)
15. Red hand flares (3 pieces)
16. Red parachute flares (2 pieces)
17. Signaling mirror (1 piece)
18. Anti-seasickness pills (6 per person)



Canister



Valise

Code			501537	501542	501547	501518	501523	501529
Code			501485	501486	501487	501488	501489	501490
Persons			4	6	8	4	6	8
Packaging			Canister			Valise		
Total Weight (kg)			30	34	36	28	30	33
Length (mm)			660	660	660	700	700	700
Width (mm)			420	420	420	300	300	320
Height (mm)			280	280	280	320	320	350

**new**



Made in Italy

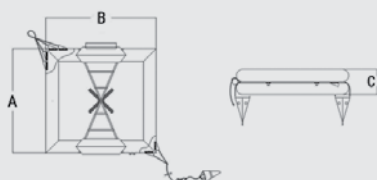

Model	Dimensions (mm)		
	A	B	C
ARIMAR COSTAL LIGHT 4	1940	2040	470
ARIMAR COSTAL LIGHT 6	1940	2040	470
ARIMAR COSTAL LIGHT 8	1940	3110	470
ARIMAR COSTAL LIGHT 10	1990	3760	580
ARIMAR COSTAL LIGHT 12	1990	3760	580

## ARIMAR COASTAL LIGHT Liferaft (IT & PG)

ARIMAR COASTAL LIGHT Liferaft is the smallest and lightest in the market. Ideal for ships flying the Italian and Portuguese flag. It is available in 4 to 12 person versions and can be packed either in a canister or in a waterproof valise. It is designed to inflate in an outdoor temperature of -15°C to +65°C. ARIMAR COASTAL LIGHT IT is also ideal for navigation within 12 miles from the coast, approved by the Italian Ministry of Infrastructure and Transport. Certified according to the Italian legislation Decreto Diriginziale 2 marzo 2009. The inspection interval depends on the flag.

### Equipment

1. Sea anchor with rope (1 piece)
2. Life ring with rope (1 piece)
3. Floating paddles (2 pieces)
4. Immediate action (1 piece)
5. Floating knife (1 piece)
6. Bailer (1 piece)
7. Sponge (2 pieces)
8. Whistle (1 piece)
9. Repair kit (1 piece)
10. Manual pump (1 piece)
11. User internal manual (1 piece)
12. Seasickness bag (12 pieces)
13. Torch kit (1 piece)
14. Drinking water (0,250 L per person) - IT



Canister



Valise



Code			500554	500555	500556	500557	500406	500558	500407	500400
Code			500791	500792	500793	500795	500760	500761	500762	500764
Persons			4	6	8	4	6	8	10	12
Packaging			Canister			Valise				
Total Weight (kg)			28	28	35	25	25	30	43,7	43,7
Length (mm)			660	660	660	670	670	640	700	700
Width (mm)			420	420	420	290	290	330	330	330
Height (mm)			280	280	280	270	270	300	360	360

\*Please note that all life rafts' dimensions and weight may slightly vary ( ±3 cm for dimensions, ±5% for weight)



Safety

**LALIZAS LEISURE-RAFT Liferaft**

Ideal for in-shore boating, the LALIZAS high quality standard Leisure-Raft is perfect for those that don't need a full feature liferaft. It is the smallest, lightest and most inexpensive liferaft in the market. The LALIZAS Leisure-Raft with its light weight allows for easy deployment, and the compact size makes storage easy in the smallest spaces.

- TPED approved CO<sub>2</sub> cylinder for easy transport
- Thermobonding technique that ensures extreme durability and reliability
- SOLAS approved water-activated compact LED light

**Standard Equipment**

- 20 ft. (6m) Painter line
- Hand pump - Sea anchor (1 piece)
- Raft knife (1 piece)
- Pressure relief valve (1 piece)
- CO<sub>2</sub> Inflation system
- Water-activated locator light
- Ballast bags (2 pieces)
- Case (1 piece)



**LEISURE-RAFT**

\*3-year recommended service interval

Valise

Code	Persons	Description	Liferaft Dimensions (mm)			Valise Dimensions (mm)			Weight (kg)
			A	B	C	Length	Width	Height	
72201	4	without canopy	225	2004	2443	410	320	140	8,20
72203	6		308	2004	2443	500	340	180	11,50
72200	4	with canopy	1170	2004	2443	410	330	150	9,10
72202	6		1200	2004	2443	500	350	190	12,50



Made in EU

with canopy

without canopy

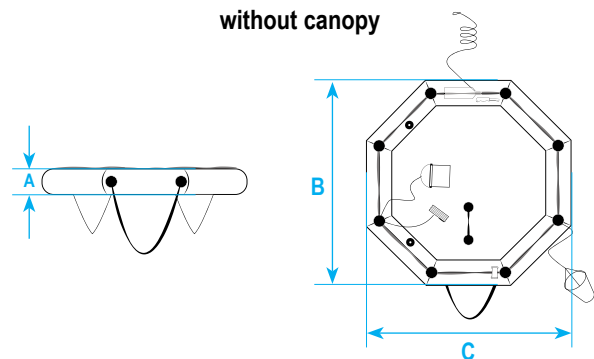
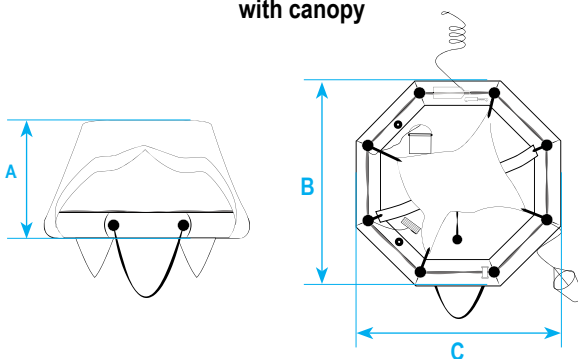

TPED approved CO<sub>2</sub> cylinder for easy transport.



Thermobonding technique that ensures extreme durability and reliability.



SOLAS approved water activated compact LED light.

\*Please note that all liferaft dimensions and weight may slightly vary ( ±3 cm for dimensions, ±5% for weight)

**new**

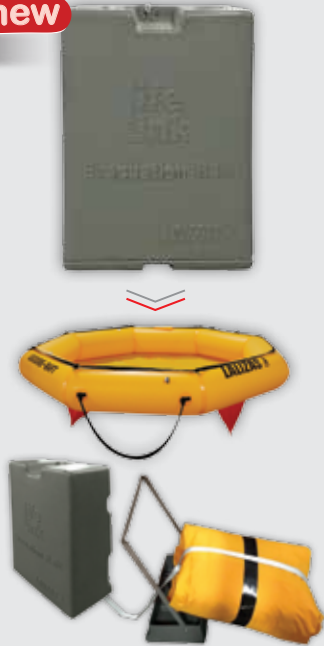

**LifeLink Evacuation Liferaft, Grey**

The LifeLink Evacuation Liferaft is one of the most manageable and user-friendly appliances in case of emergency. It is designed for the LALIZAS Leisure Liferaft - 4 persons (the liferaft is included) and guarantees rapid deployment in an M.O.B. situation. By mounting the LifeLink Evacuation Liferaft on the rails, the user manages to save valuable stowage space on board.

**Features**

- Material HDPE with UV protection
- All metal components of stainless steel
- Created via rotomolding

**Made in EU**



Distance between horizontal rails: 310 mm ± 20 mm

Code | 73668

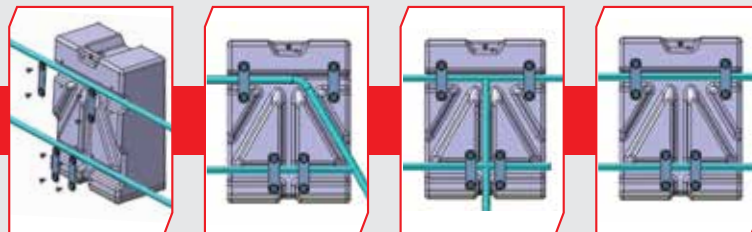

**Mounting on the rails**

\*3-year recommended service interval



**LALIZAS Liferaft SOLAS OCEANO, Throw-overboard Type**

Ideal for use onboard commercial vessels engaged on international voyages.

- 6, 8, 10, 12, 16, 20, 25, 30 & 35 person - Pack A & Pack B - Throw overboard
- Deck cradle included in the box
- Stowage Height up to 36m (painter line up to 46m)



Flat Pack

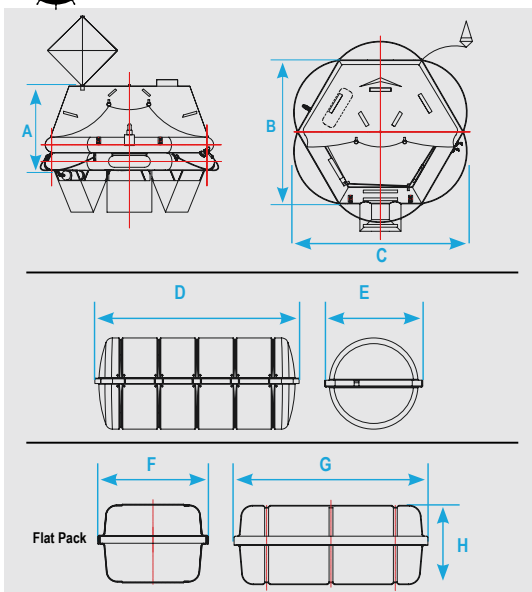

Code	Persons	Pack	Dimensions (mm)							
			A	B	C	D	E	F	G	H
79867	6	A	1200	2104	2104	1090	615	-	-	-
79903		B				1045	545	-	-	-
79868	8	A	1250	2390	2390	1090	615	-	-	-
79880		Flat - A				-	-	564	994	405
79904	B					1045	545	-	-	-
79869	10	A	1400	2694	2694	1230	630	-	-	-
79905		B				1090	615	-	-	-
79870	12	A	1500	2924	2924	1230	630	-	-	-
79882		Flat - A				-	-	664	1044	405
79906	B					1090	615	-	-	-
79872	16	A	1600	3330	3330	1285	670	-	-	-
79908		B				1230	645	-	-	-
79873	20	A	1600	4304	2974	1335	696	-	-	-
79909		B				1285	670	-	-	-
79874	25	A	1650	4894	3194	1490	757	-	-	-
79910		B				1335	696	-	-	-
79875	30	A	1700	5384	3414	1700	765	-	-	-
79911		B				1490	757	-	-	-
79876	35	A	1750	5899	3568	1700	765	-	-	-
79912		B				1490	757	-	-	-





Safety



**LALIZAS Liferaft SOLAS OCEANO,  
Throw-overboard Self-righting Type**

Code	Persons	Pack	Dimensions (mm)					
			A	B	C	D	E	H
72549	25	A	2250	3130	5350	1700	765	680
72552		B				1490	757	678
72550	50	A	2900	4275	7470	2095	895	877
72553		B				1800	810	700
72551	100	A	3400	5380	11090	2400	1050	1050
72554		B				2095	895	995

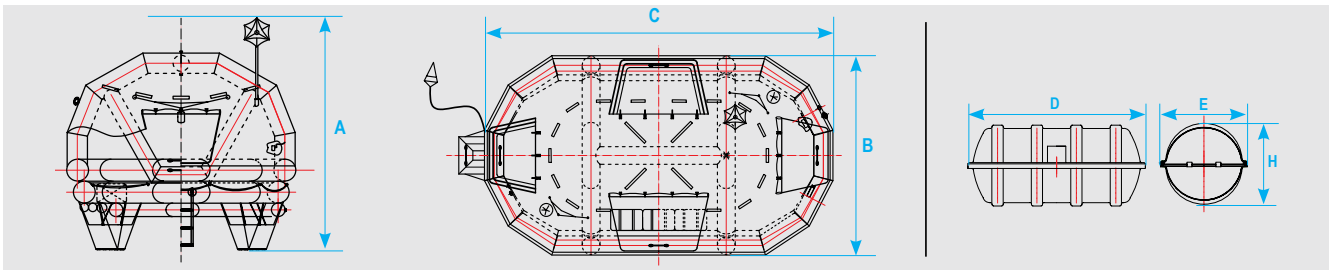

**LALIZAS Liferaft SOLAS OCEANO, Davit-launched Type**

Can be used at all kinds of vessels, providing safe evacuation from the vessel's deck.



Code	Persons	Pack	Dimensions (mm)					
			A	B	C	D	E	H
73134	16	A	1800	3392	3302	1350	700	700
73135		B				1285	670	670
79885	20	A	1850	3815	3715	1470	750	710
79888		B				1350	700	660
79886	25	A	2000	4225	4065	1680	770	710
79889		B				1470	750	710

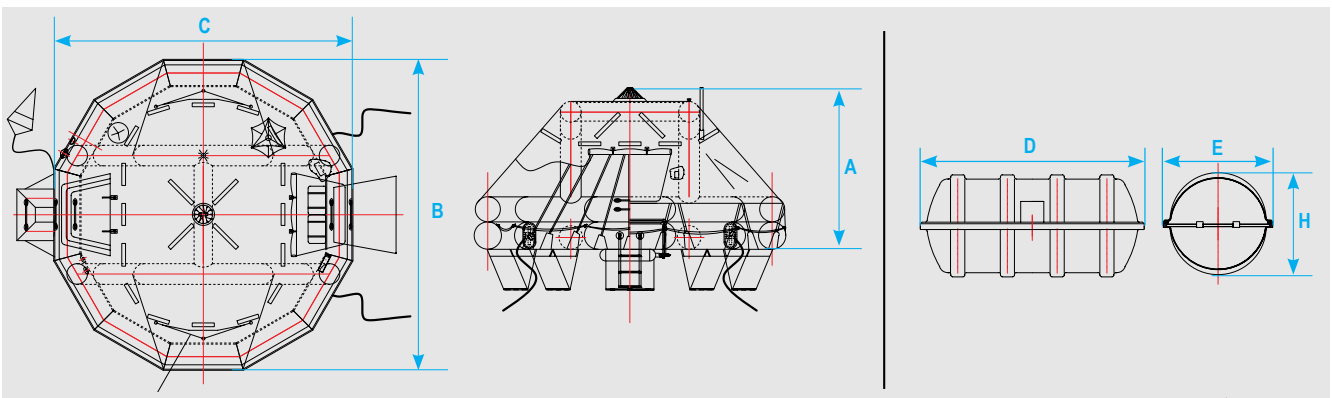

## LALIZAS Liferaft SOLAS OCEANO, Davit-launched Self-righting Type

Can be used at all types of passenger vessels, providing safe evacuation from the vessel's deck.

Code	Persons	Pack	Dimensions (mm)					
			A	B	C	D	E	H
73138	16	A	1950	2950	4270	1470	750	710
73142		B				1350	700	660
73139	20	A	2200	2860	4700	1680	770	710
73143		B				1470	750	710
73140	25	A	2380	3240	5255	1660	820	715
73144		B				1470	750	710
73141	37	A	2600	3780	6280	1875	850	835
73145		B				1660	820	715

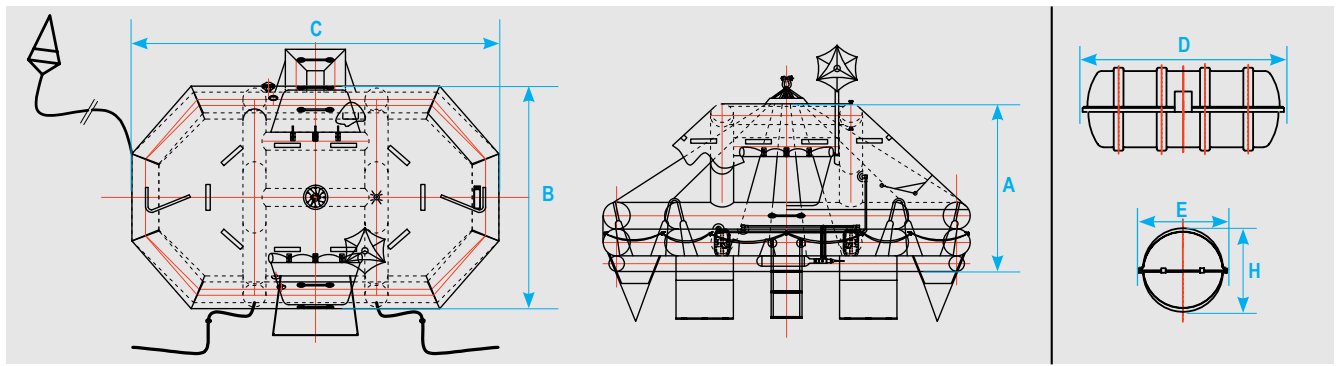

## LALIZAS Liferaft SOLAS OCEANO, Open Reversible Type

Ideal for passenger ships operating in inland or coastal waters.



Code	Persons	Pack	Dimensions (mm)					
			A	B	C	D	E	H
79898	25	HSC	712	4114	4114	1090	615	530
79899	30		746	4474	4474	1230	630	550
79900	50	HSC	854	5680	5680	1490	757	678
79901	65		914	6434	6434	1700	755	680

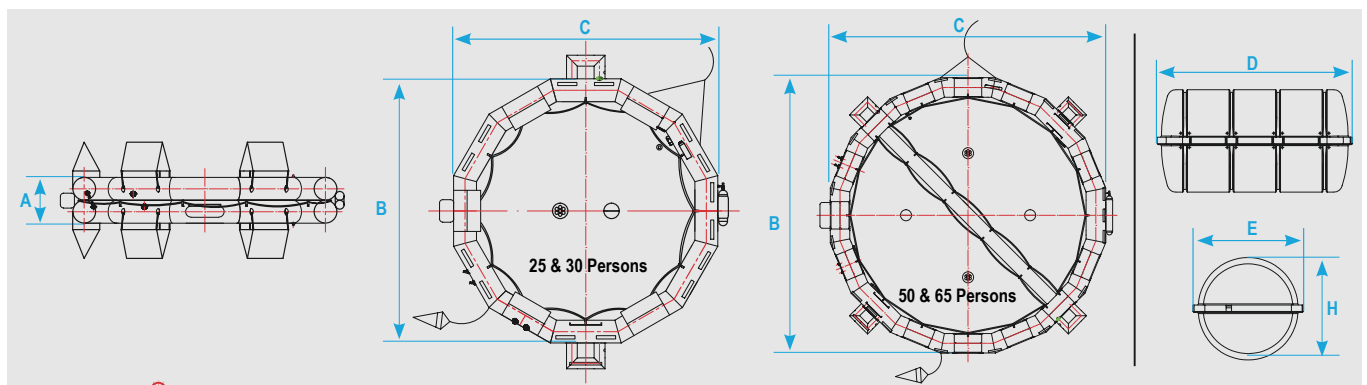



Safety



**LALIZAS Hydrostatic Release Unit for Liferafts, SOLAS/MED/USCG**

LALIZAS HRU mechanism is the outcome of a long-term experience in liferafts' manufacturing, designed and produced in the EU (in Greece), in accordance with SOLAS/MED/USCG regulations. It can easily be installed on board, attached to the liferaft according to instructions. The mechanism is being automatically activated, in the event of sinking, in a depth of between 1.5 and 4m, allowing the liferaft to be inflated and detached from the sinking vessel. It can be installed to all liferafts of 4-150 persons.

- No maintenance required
- Requires replacement 2 years after installation on board
- Max. lifetime: 5 years after production date
- Tested & approved by Force Certification A/S
- SOLAS/MED/USCG approved

Code | 73595



Made in Greece

**LALIZAS Lashing with Hook**

Suitable for:  
 • All Hydrostatic Release Units  
 • LALIZAS OCEANO Liferaft (all types)

Code	71892	72748
For life rafts	6-35 prs	> 50 prs



**Liferaft LED Flashlight**

AA Alkaline 1,5V x 2pcs  
 (batteries are not included)

**new**

**LALIZAS LRL External & Internal Liferaft Light, SOLAS/MED/USCG**

LALIZAS External & Internal Liferaft Light is included in the basic equipment of the liferaft, having a compact size and structure. Its features make the installation to the life raft easy and safe while it is fully sealed and watertight. The external flashing light is designed to produce a minimum of 4.3 cd and the internal steady light a minimum of 0.5 cd. LALIZAS External & Internal Liferaft Light has a minimum duration of 12 hours and both lamps can be controlled individually. It has lithium battery and LED light and the storage lifetime is 5 years. LALIZAS LRL comes with 70 cm lead length, but this can be varied, subject to the liferaft size and specs. Storage & operating temperature: -30° C to +65° C. SOLAS/MED/USCG approved.



Code	Description
72352	LALIZAS LRL Power Unit with Internal Liferaft Light, SOLAS/MED/USCG
72351	LALIZAS LRL External Liferaft Light, with 1m lead, for PU & Rubber surface, SOLAS/MED/USCG
73675	LALIZAS LRL External Liferaft Light, with 1,80m lead, for PVC surface, SOLAS/MED/USCG



Safety

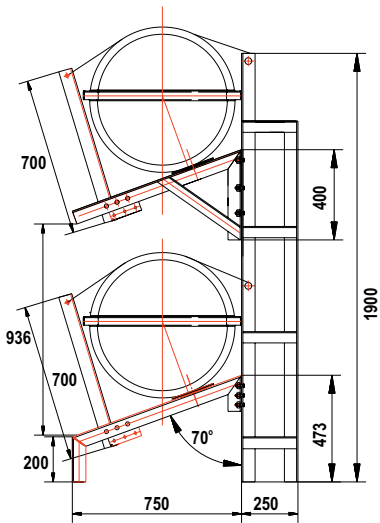

**Vertical Cradle for SOLAS OCEANO, 2-tier, 6-25(A), 6-35(B)**

Code | 72119

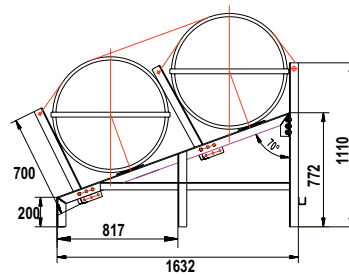

**Cradle for SOLAS OCEANO, 2-tier, 30-35(A)**

Code | 72136

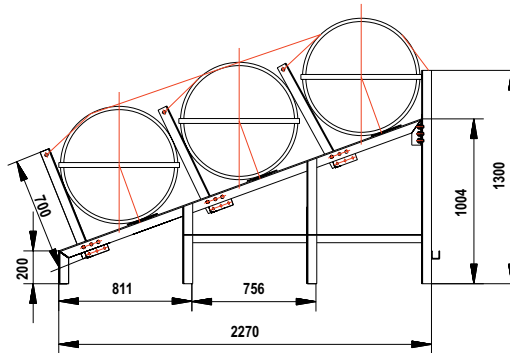

**Cradle for SOLAS OCEANO, 3-tier, 6-25(A), 6-35(B)**

Code | 72120

Dimensions are in mm



**LALIZAS Thermal Protective Aid Alusafe-T, LSA Code**

- Meets the LSA code requirements
- Protects the wearer from hypothermia, which may be caused by prolonged exposure in liferaft and rescue boats
- Offers survivor's protection from wind and cold
- Made of aluminium film coated fabric
- The low thermal conductivity of aluminium reduces both the convective and evaporative heat loss from the wearer's body and preserves stable temperature
- Covers the fully clad body, wearing even a lifejacket
- Available in one size, in silver colour

Code | 70461



Height range : 1,45 - 2,00 m  
Weight range: 40-150 Kg

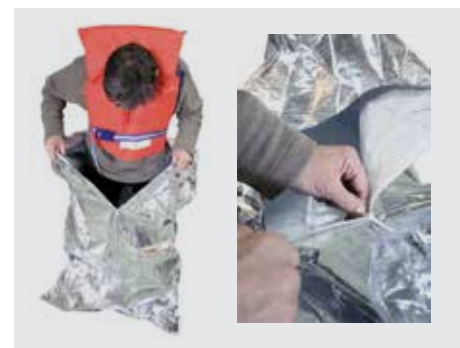

**LALIZAS Emergency Liferaft Drinking Water 4x125ml**

Code | 56700



**LALIZAS Emergency Liferaft Food Ration 0,5 kg**

Code | 57070



Safety



### Mooring Ring with 30m Rope Ø4mm

Designed for the retrieval of MOB, the ring is moulded in PVC, weighing only 250gr and it is tied to a 30m floating rope.

Ext. Diam.: 166 mm  
Int. Diam.: 110 mm

Code | 20693



### Signalling Mirror 7x7cm

**Instructions of use:**

1. Hold the foresight in your left hand with arm fully extended
2. Hold the signalling mirror in right hand toward the sunlight, facing the back of the mirror
3. Align the holes of the foresight and the mirror on the target
4. Move the mirror until the reflection of the sun from the mirror can be seen on the foresight and a shadow point appears in its hole
5. The ray is now directed at the target

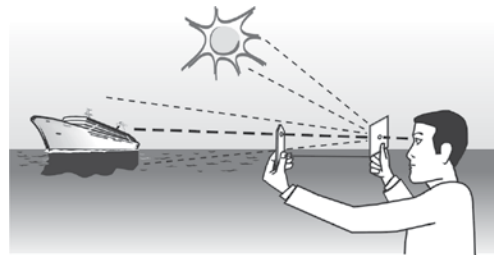

Code | 56570

### Thermal Blanket, 2,1 x 1,6m



- First Aid Application
- In case of severe cold or shock wrap the blanket around the body
- Keeps the body's temperature under very low or very high temperatures
- Prevents post – accident shock
- Waterproof
- Its reflective surface provides high visibility
- Dimensions: 2,1 x 1,16m

Code | 70976

### Thermal Blanket, Advanced, 2,1 x 1,6m



**Application:** The thermal blanket helps you keep the body's temperature by protecting you from the sunrays and the very low temperatures. It is suitable for use in cases of accident, but also for protection against wind, rain or heat.

**Instructions:** When you need to avoid hypothermia, use the thermal blanket with the golden side facing upwards. In case you need protection from the heat, use the thermal blanket with the silver side facing upwards.

Code | 70975



### First Aid Kit SOLAS 74, for Lifeboats - Liferafts

Certified by the Ministry of Merchant Marine/Merchant Ships Directorate according to (a) the International Convention on the Safety of Life at Sea 1974 (SOLAS 74) and the 1983 amendments, (b) the Royal Decree 36/1967 and (c) the Presidential Decree 277/1997.

**Contents:**

Anti-Angina Preparations, Anti-Hemorrhagics Including Uterotonics, Anti-Acid Mucous Dressings, Anti-Emetics, Anti-Diarroals, Analgesic-Antipyretics, Analgesic-Anti-Inflammatory Preparation, Antiseptic Mercurochrom, Antiseptic Eau Oxygenee, Burn Preparation, Cannula for Mouth to Mouth Resuscitation, Adhesive Elastic Bandage, Sterile Gauze Compresses, Cotton Wool, Disposable Polyethylene Gloves, Adhesive Dressings, Sterile Compression Bandages, Adhesive Sutures, Sterile Gauze with Fatty Water and Vegetable Oils for Burns, Adhesive Tape, Scissors, Thermometer, Disposable Syringes 2.5ml - 5ml

Code | 71245



### First Aid Kit-Non SOLAS

**Contents:**

- Anti-Angina Preparations
- Anti-Emetics
- Analgesics – Antipyretics
- Analgesics – Anti-Inflammatory Preparation
- Antiseptic Hydro Peroxide
- Burn Preparation
- Cannula for mouth to mouth Resuscitation
- Adhesive elastic bandage
- Sterile Gauze Compresses
- Cotton
- Adhesive Dressings
- Sterile Pressure Bandages
- Adhesive Sutures
- Adhesive Tape
- Sterile Gauze with water & vegetable oils for burns
- Scissors

Code | 56880

## Liferaft Equipment



Safety

**LALIZAS**

### Liferaft Support Base, Inox

min 810x415x225 mm  
max 930x415x225 mm

Code | 70620

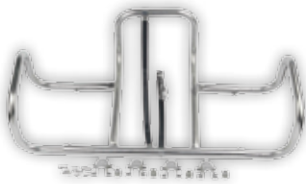

**Nuova Rade**

### Liferaft Support Base

Code | 44838



### Buoyant Paddle for Liferafts, Black

Code	Length (cm)	Diameter (mm)
71851	51,5-76,5	25



### Bailer Flexible, Floating, Petrol Blue

190 x 135 mm (L x W)

Code | 16207



### Inflation/Deflation (PVC) Valve for ISO-RAFT

Code | 02022

## Breathing Apparatus

**LALIZAS**

### LALIZAS Emergency Evacuation Breathing Device / EEBD "ESCAPE-15", SOLAS/MED

LALIZAS Emergency Escape Breathing Device (EEBD) ESCAPE-15 complies with the amended SOLAS ch.II-2 and the IMO MSC/Circ.849. All ships on international routes must carry EEBDs on board.

#### Characteristics:

- Full-face hood universal size, suitable for every face shape
- 15 min. steady air-flow with sufficient air-delivery rate
- Flame resistant
- Activated with a single move
- Easy visual access on the pressure gauge
- Durable & reliable construction with low maintenance
- Silver colour to reflect heat and be highly visible
- Easy to refill cylinder (no adaptor required)
- Working temperature range: -10°C to 65°C



Code	70321
Volume	14300cm <sup>3</sup>
Weight	6150gr
Height	22cm
Width	13cm
Length	50cm

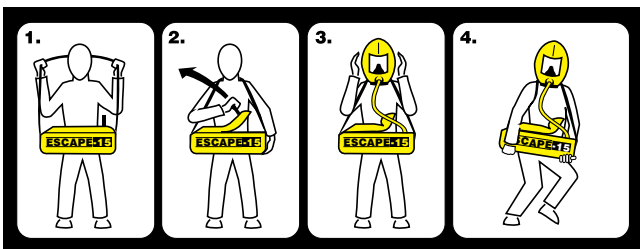

#### Accessories



### Wall Bracket for EEBD

Code | 01623



### Plastic Cover for EEBD

Code | 01622



- Ozone resistant
- Non irritant neck seal
- Wide visor
- Non irritant
- Antimisting design for the visor



- Automatic activating valve - regulator
- Valve features G 5/8" F standard charging connector
- Pull valve safety lock



- Shock proof - antiblast pressure gauge
- Coloured so as to have easy readings for duration
- Overpressure - internal pressure of the cylinder



Safety

## Spare Compressed Air Cylinder & Valve 300bar Assembly with Air



Code	Cylinder Volume (L)
02302	6
02303	9

## LALIZAS Self Contained Breathing Apparatus / SCBA, SOLAS/MED

LALIZAS SOLAS/MED Self Contained Breathing Apparatus is a high-performance breathing apparatus, designed to offer maximum respiratory protection to the user during entrance or escape from a hazardous environment. This SOLAS/MED -approved SCBA offers reliability and comfort and its key features are:

- Open circuit on demand positive pressure Self Contained Breathing Apparatus
- Anatomic carbon fibers composite material back frame with harness for perfect and easy donning
- Both back frame and harness are flame retardant, waterproof and antistatic
- With manometer and whistle (>90Db) warning the user that the air is dropping down below 50bar

It is available in two versions:

- With a 6L cylinder (steel)
- With a 9L cylinder (carbon composite)

The SCBA contains the following parts:

- Breathing apparatus carrier with harness
- Pressure regulator with manometer & whistle
- Pressure & air flow regulator
- Breathing apparatus facemask
- Compressed air cylinder with EU Standard Valve G5/8" thread

Packed in heavy-duty plastic carrying suitcase



Code	Cylinder Volume (L)	Cylinder Material	Working Pressure (Bar)	Warning Pressure (Bar)	Weight (kg)	Packing Dimensions (cm)	Approval
71327	6	Steel	300	50-60	≤15	270x490x755	SOLAS/MED
71328	9	Carbon Composite	300	50-60	≤12	280x445x735	SOLAS/MED

## Fire Fighting Equipment



Code	Inner Diam (inch/mm)	Coupling	Length (m)	SOLAS/MED approved
71698	1.5" / 38	Storz 38 Brass	15	Yes
71699	1.5" / 38	Storz 38 Brass	20	Yes
72499	1.5" / 38	Storz 38 Brass	25	Yes
71705	2" / 52	Storz 50 Brass	15	Yes
71706	2" / 52	Storz 50 Brass	20	Yes
71707	2" / 52	Storz 50 Brass	25	Yes
74460	2" / 52	Storz 50 Brass	30	Yes
71711	2.5" / 64	Storz 65 Brass	15	Not applicable
71712	2.5" / 64	Storz 65 Brass	20	Not applicable
71713	2.5" / 64	Storz 65 Brass	25	Not applicable
74461	2.5" / 64	Storz 65 Brass	30	Not applicable
72500	1.5" / 38	Nakajima 38 Brass	15	Yes
72501	1.5" / 38	Nakajima 38 Brass	20	Yes
72502	1.5" / 38	Nakajima 38 Brass	25	Yes
72503	2" / 52	Nakajima 50 Brass	15	Yes
72504	2" / 52	Nakajima 50 Brass	20	Yes
72505	2" / 52	Nakajima 50 Brass	25	Yes
74462	2" / 52	Nakajima 50 Brass	30	Yes
72506	2.5" / 64	Nakajima 65 Brass	15	Not applicable
72507	2.5" / 64	Nakajima 65 Brass	20	Not applicable
72508	2.5" / 64	Nakajima 65 Brass	25	Not applicable
74463	2.5" / 64	Nakajima 65 Brass	30	Not applicable

Code	Inner Diam (inch/mm)	Coupling	Length (m)	SOLAS/MED approved
74464	1.5" / 38	Barcelona 45 Aluminium	15	Yes
74465	1.5" / 38	Barcelona 45 Aluminium	20	Yes
74466	1.5" / 38	Barcelona 45 Aluminium	25	Yes
74467	1 3/4" / 45	Barcelona 45 Aluminium	15	Yes
74468	1 3/4" / 45	Barcelona 45 Aluminium	20	Yes
74469	1 3/4" / 45	Barcelona 45 Aluminium	25	Yes
74470	1 3/4" / 45	Barcelona 45 Aluminium	30	Yes
74471	2" / 52	Barcelona 70 Aluminium	15	Yes
74472	2" / 52	Barcelona 70 Aluminium	20	Yes
74473	2" / 52	Barcelona 70 Aluminium	25	Yes
74474	2" / 52	Barcelona 70 Aluminium	30	Yes
74475	2.5" / 64	Barcelona 70 Aluminium	15	Not applicable
74476	2.5" / 64	Barcelona 70 Aluminium	20	Not applicable
74477	2.5" / 64	Barcelona 70 Aluminium	25	Not applicable
74478	2.5" / 64	Barcelona 70 Aluminium	30	Not applicable
74479	1 3/4" / 45	UNI 45 Brass	15	Yes
74480	1 3/4" / 45	UNI 45 Brass	20	Yes
74481	1 3/4" / 45	UNI 45 Brass	25	Yes
74482	1 3/4" / 45	UNI 45 Brass	30	Yes

## LALIZAS Fire Hose with coupling



Code	Inner Diam (inch/mm)	Length (m)	SOLAS/MED approved
74485	1 3/4" / 45	15	Yes
74486	1 3/4" / 45	20	Yes
74487	1 3/4" / 45	25	Yes
74488	1 3/4" / 45	30	Yes
72509	1.5" / 38	15	Yes
72510	1.5" / 38	20	Yes
72511	1.5" / 38	25	Yes
72512	2" / 52	15	Yes
72513	2" / 52	20	Yes
72514	2" / 52	25	Yes
74484	2" / 52	60	Yes



Code	Inner Diam (inch/mm)	Length (m)	SOLAS/MED approved
72515	2.5" / 64	15	Not applicable
72516	2.5" / 64	20	Not applicable
72517	2.5" / 64	25	Not applicable
74483	2.5" / 64	60	Not applicable

## LALIZAS Fire Hose



## LALIZAS Fire Hose Couplings



Storz

Code	Coupling
72518	Storz 38 brass
72520	Storz 50 brass
72522	Storz 65 brass



Nakajima

Code	Coupling
72519	Nakajima 38 brass
72521	Nakajima 50 brass
72523	Nakajima 65 brass



Barcelona

Code	Coupling
74490	Barcelona 45 tail 1 3/4" Aluminium
74491	Barcelona 45 tail 1 1/2" Aluminium
74492	Barcelona 70 tail 1 1/2" Aluminium



UNI

Code	Coupling
74489	UNI 45 Brass



Storz

### LALIZAS Fog Nozzle 3 position

Code	Fog Nozzle
72524	Storz 38 brass
72526	Storz 50 brass
72528	Storz 65 brass
72525	Nakajima 38 brass
72527	Nakajima 50 brass
72529	Nakajima 65 brass
74511	Barcelona 45 Aluminium
74512	Barcelona 70 Aluminium
74513	UNI 45 Brass



Nakajima



Storz

### Blank Cap & Chain

Code	Blank Cap
74502	Storz 1 1/2" Brass
74503	Storz 2" Brass
74504	Storz 2 1/2" brass
74505	Nakajima 1 1/2" Brass
74506	Nakajima 2" Brass
74507	Nakajima 2 1/2" brass
74508	Barcelona 45 Aluminium
74509	Barcelona 70 Aluminium
74510	UNI 45 Brass



Nakajima



Barcelona



### LALIZAS Fireman Axe with Long Wooden Handle 2,8kg

This long fireman's axe is the ideal tool for demolition work.

**It features:**

- High carbon steel blade
- 12cm cutting edge
- Overall length: 90cm
- Weight: 2.8kg
- Pick spike for piercing and prying
- Wooden ash handle
- Rubber protective blade cover

Code | 71685



### LALIZAS Fireman Axe with Short Anti Slip Handle 1,2kg

This short fireman's axe provides heavy duty chopping power to gain access to locked doors and hollow walls during an emergency.

**It features:**

- High carbon steel blade
- 9cm cutting edge
- Overall length: 34cm
- Weight: 1.2kg
- Pick spike for piercing and prying
- Anti slip handle
- Rubber protective blade cover

Code | 71686

### **new** LALIZAS Holster for Fireman Axe

Synthetic leather cover for carrying a fireman axe safely on the belt.

- No restriction on movements
- Made out of one piece of leather, which reduces seams
- Solid metal rivets placed to hold the holster together
- Metal snap for easy on/off action
- Fits perfectly the LALIZAS Fireman Axe with Short Anti Slip Handle 1,2kg (code 71686)
- Can be attached to Fireman Belt, with Restraint Lanyard, M-XL (85-120cm), EN358, CE (code 74583) or Fireman Belt, Heavy Duty, with Safety Line L0,9m, CE (code 74582)

Code | 74584







## LALIZAS Fire Extinguishers

LALIZAS range of portable Fire Extinguishers, specially designed for the marine sector, provides additional protection from environmental induce, high fire protection effectiveness due to reinforced extinguishing ability and simplicity in application.

### Other features:

- Large diameter of the safety pin ensures an easy grip even with work gloves
- Shock-proof pressure gauge facilitates accurate indication of pressure status
- Seamless cylinder production technology facilitates avoidance of weakening points, enhances tightness and pressure resistance
- Easy to use



Safety

Code / Language Label	EN, IT, GR	704431	704441	704451	704461	400691	474621	499521
	EN, ES, HR	704432	704442	704452	704462	400692	474622	499522
	EN, FR, DE	704433	704443	704453	704463	400693	474623	499523
	Capacity	1 kg	2 kg	3 kg	6 kg	9 kg	9l	5 kg
	Extinguishing agent	Dry Powder	Dry Powder	Dry Powder	Dry Powder	Dry Powder	Foam	CO <sub>2</sub>
	Body	Aluminium alloy	Aluminium alloy	Steel	Steel	Steel	Aluminium alloy	Steel
Technical Data	Fire Ratings	5A 34B C	13A 89B C	13A 89B C	34A 233B C	43A 233B C	27A 233B	89B
	Dimensions (mm)	82X295	108X378	130X385	160X520	190X545	180X615	136X743
	Weight (kg)	1,26	2,55	4,60	8,60	12,50	11,50	13,90
	Special Features	Corrosion resistant shock-proof pressure gauge	Corrosion resistant shock-proof pressure gauge	Corrosion resistant shock-proof pressure gauge	Corrosion resistant reinforced rubber hose	Corrosion resistant shock-proof pressure gauge	Corrosion resistant	Corrosion resistant shock-proof pressure gauge
Accessories	Base	Plastic bracket for vehicle & marine use	Plastic bracket for vehicle & marine use	Stainless steel wire bracket, mounting in horizontal or vertical position	Wall bracket for vertical mounting	Wall bracket for vertical mounting	Wall bracket for vertical mounting	Wall bracket for vertical mounting
	Nozzle				Hose & nozzle	Rubber hose, nozzle	Spray nozzle	Rubber hose & polyamide horn



Ordinary Solid Combustibles



Flammable liquids and gases



Flammable gases, Energized electrical equipment

Fire Extinguisher Type	Type of Fire				
	Solids (wood, paper, cloth, etc.)	Flammable Liquids	Flammable Gases	Electrical Equipment	Oil & Fats
Dry Powder	✓	✓	✓	✓	✓
Foam	✓	✓	✗	✗	✓
CO <sub>2</sub>	✗	✓	✗	✓	✓

### Marine Brackets for LALIZAS Fire Extinguishers

With unique design which facilitates the fire extinguisher to stay steady even in harsh sea conditions.

- Heavy duty (made of metal components)
- Suitable for vertical mounting
- Easy to install
- Includes adjustable stainless steel belt for extra security & quick release

Code	For LALIZAS Fire Extinguishers	Cylinder Diameter (mm)
73646	Dry Powder 6kg	16
73647	Dry Powder 9kg	190
73648	Foam 9lit	180
73649	CO <sub>2</sub> 5kg	136



## Fire Fighting Equipment



Safety



### LALIZAS Fire Blanket in a PVC case

The fire blankets are essential in high-risk areas, such as the kitchen. The offered models are 100x100cm and 120x180cm and supplied in a rigid case, with instructions printed on the top. In accordance to EN 1869.

Code	70448	71298
Dimensions (cm)	100x100	120x180

\* silicone coated



### Storage Case for Fire Extinguisher

Allows safe and protected storage of a fire extinguisher in the cockpit or dashboard. This product is impervious to harsh weather, watertight and offers easy and safe access during emergency situations. A well-made product that offers very precise lid/door closure. Made of UV-resistant white ASA. The elimination of metal reduces the chance of personal injuries. No sharp corners. No glass to shatter.



Code	Fire Extinguisher Capacity (kg)	Door	Colour
196461	1	Yes	White
196666		Transparent	
50006		No	
196465	2	Yes	
196675		Transparent	
50010		No	

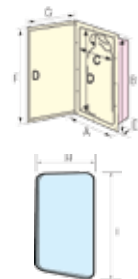

Fire Extinguisher (kg)	A (mm)	B (mm)	C (mm)	D (mm)	E (mm)	F (mm)	G (mm)	H (mm)	I (mm)
1	174	424	120	370	105	434	196	124	374
2	204	474	150	415	120	484	226	154	424

## Marine Distress Signals & Pyrotechnics

Available only in certain countries



new

### LALIZAS Parachute Rocket, SOLAS/MED/USCG

Night and day distress signal for fishing boats, commercial vessels, recreational boats and liferafts. Suitable for marine use only

- Visibility: 30 mg
- Ejection height: 300 mt
- Duration: 40 secs at 30.000 candelas

Code | 500422



### LALIZAS Hand Flare, SOLAS/MED/USCG

Night or day distress signal. Should be used only in sight of a plane or vessel.

- Duration: 60 secs to 15.000 candelas

Code | 500424



### LALIZAS Dry Bag for Distress Signals/Pyrotechnics



Code | 74636

- Dimensions: Ø16 x 48 cm
- Material: Transparent PVC

\* Distress Signals not included

### LALIZAS Buoyant Smoke Signal, SOLAS/MED/USCG

It emits orange smoke. Safe to use it on petrol or oil covered water. Highly recommended to use it during the day. Should be used only in sight of aircraft or vessel. Intended exclusively for marine use.

- Gross weight: 390 g
- Burning time: 3 minutes

Code | 500823





Available only in certain countries



Safety

Hand Signal  
LSA Code



Code | 70230

Hand Signal



Code | 70200

Parachute Signal  
LSA Code



Code | 70220



Smoke Signal

Κωδικός	70210	74694
Approval	LSA Code	CE



Manoverboard  
& Brackets

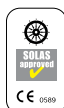

Code | 9990204



Linethrower  
250 Body & Line

\* without rocket



Code | 9990206

Floating  
Smoke Signal



Code | 9990203



Parachute Rocket,  
Red

Code | 9990202



Handflare,  
Red

Code | 9990201



Linethrower 250 Rocket



Code | 9990105



Storage Bottles

Ideal for storing safety equipment, medicine or personal belongings. Silicone gasket for optimum water resistance. You can also use a carrying rope.

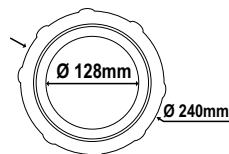

Code	39642	39643	39644	39645
Capacity (lt)	6	8	12	15
Diameter (mm)	240			
Height (mm)	195	260	380	440



Safety



**Signal Horn 380 ml, Set**  
Acoustic range approximately 1500 m.

**Instructions**

1. To install the horn, you need to screw it on the pressurised container
  2. For operation, press down the horn
  3. The signal horn must always be used in upright position
- Do not store the pressurised container in direct sunlight. Do not expose to sunlight for very long hours or to temperatures exceeding 40 °C. Do not pierce or burn after use.

Code | 10033



**Refill Horn Canister, 380ml**

Code | 10032



**Fog Horn Head Only**

Code | 10031



**Signal Horn ECO 300 ml, Set**

- Non-flammable Gas
- 99,5% Lower GWP

Code | 72327



**Refill Canister 300ml for Signal Horn ECO 72327**

Code | 72903



Code | 16183

**Fog Horn, Red**

Highly resistant polyamide.  
Length: 30 cm  
Ø 8 cm



**Megaphone with Siren**

- Diameter: 200mm
- Length: 330mm
- Power: 20W
- Sound Coverage: 400m approx.
- Function: Talk/Siren (or Music)
- Batteries: 6x1,5V (size C)
- ABS Housing

Code | 90168

**Mega Horn**

Whether you use Mega Horn in an emergency or for pleasure you certainly will be heard. Sound measures at 105 D.B. Available in red colour, it comes complete with counter merchandising display box.

- Floating, non-corrosive
- Friendly to the environment
- Available in showcases of 12pcs

Code | 10040



**Nautical Whistle**

- Commercial grade, non-corrosive, pea-less marine whistle
- Manufactured in accordance with SOLAS 74/83
- Certified per ISO 12402-7 & 8
- Approvals: EN394, 396, BG-PRUFZERT-94-13-506 (GERMANY)

Code	70010	70020
Colour	Blue	Orange

Available code with lanyard, USCG/SOLAS

Code	28104
Colour	Orange



**Signalling Mirror 7x7cm**

**Instructions of use:**

1. Hold the foresight in your left hand with arm fully extended
2. Hold the signalling mirror in right hand toward the sunlight, facing the back of the mirror
3. Align the holes of the foresight and the mirror on the target
4. Move the mirror until the reflection of the sun from the mirror can be seen on the foresight and a shadow point appears in its hole
5. The ray is now directed at the target

Code | 56570

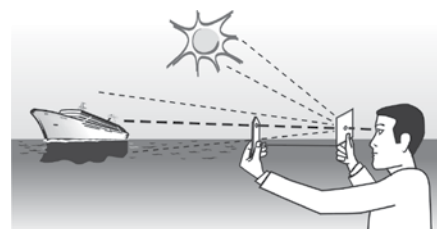



Safety

### Day Signals

- Required on board by the International Regulation COLREG, as amended
- Mast head signals visually indicating the status of a vessel to other vessels on navigable waters during daylight hours
- Made of heavy-duty fabric with foldable inner framing with webbing, which is fully collapsible and offers quick and easy storage
- Both ball and diamond shapes are in black colour

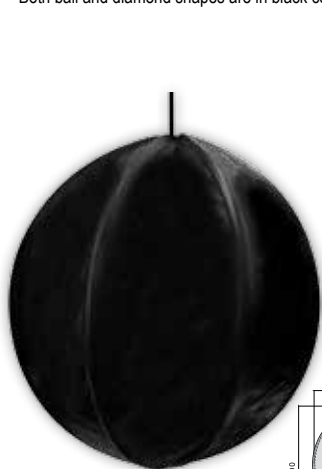

**Day Signal, Ball, Ø 600mm**

Code | 72731

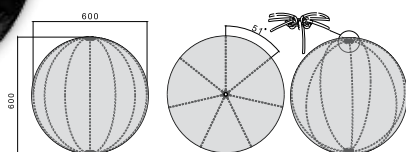

**Day Signal, Diamond, 1200x600mm**

Code | 72732

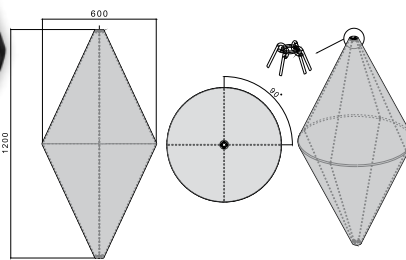

**Black Ball (Anchor Signal)**

- Internationally recognised daytime signal, used by boats when at anchor
- Made of highly resistant plastic
- Folds easily for storage

Code	Diameter (mm)
16185	300
39553	350



**Black Cone**

This signal must be displayed on sailing boats, when travelling under power.

Code	Dimensions (mm)
16206	350x340
39552	470x330

### Radar Reflector, Tube Type

- Enhances your boat's signal on the area's radars
- Useful, not only on emergency cases but also on situations when visibility is low and other nearby vessels cannot see you
- Reflects energy from the radars and thus enhances the signal of the vessel
- Eyes on both sides allow the unit to be secured to the shroud
- Made of aluminium elements crossed at several 90° angles in a plastic casing, very high reflecting rate
- Lightweight and compact design
- Practical and noiseless

Code	Description	Length (cm)	Diameter Ø (cm)
72075	For sailboat	59	5
72076	For powerboat	57	



**Radar Reflector**

It is made of light alloy. Provided with head plastic protection. Folding model for easy storage when not required. Packed in a plastic bag.

Code	Description	Dimensions (mm)
97638	Standard 12"	215x215x300
97639	R.O.R.C 16"	300x300x415
35000	R.O.R.C 18"	340x340x470

### Signalling Mirror with Red Dot

One of the most reliable, effective signalling devices. It features an aiming spot to assist you in flashing in the intended direction. Ø 86 mm.

Code | 27177



## Smoke Detectors

Available only in certain countries

**LALIZAS**

Safety

new



### Gas Detector CC-3000, Gas Alarm

- Hot wire type sensor
- Ideal for all kitchens
- Self test function
- Durable sensor head
- Modernized design
- High accuracy

- Sensor self diagnostic on the electronic circuit
- Easy installation and maintenance
- Loud sound signal of 85 dB at alarm mode
- Excellent reliability & high stability
- Less affected by other organic solvent
- Three years limited warranty



Code | 45494

Approved to EN50194

## Emergency Equipment Devices

Available only in certain countries

**ocean SIGNAL**

### Man Overboard Locator Beacon MOB1



- Needs to be pre-installed within the lifejacket\*
- AIS (Automatic Identification System)
- Integrated DSC transmitter (digital selective calling)
- 30% (typ) smaller than competitors
- Automatic activation
- Simple lifejacket integration
- 7 year battery life
- 24+ hours operational life
- 5 year warranty\*\*
- Fast accurate positioning
- Height 134 x Width 38 X Depth 27 mm



Code | 72252

\*Always refer to the manufacturer for specific instructions before installing this product directly to your lifejacket.  
\*\*Subject to warranty statement. Note: When used in commercial applications, the warranty period is restricted to 2 years.

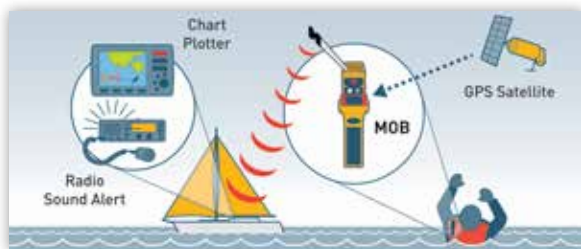

### Search and Rescue Transponder S100



- Compact size for easy liferaft packing
- Superior battery life (12h operating use after 96h stand by) even in very low temperatures
- User replaceable & non-hazardous battery
- Replaceable battery
- Telescopic pole and mounting bracket included
- MED & FCC certified

Code | 72256



### Electronic Distress Flare EDF1



Code | 72253



Available only in certain countries



Safety



**Emergency Position Indicating Radio Beacon EPIRB1 Pro, with housing**

Height 340 (Antenna up) x Width 100 X Depth 89 mm  
Weight 442gr  
Housing: Height 237 x Width 121 X Depth 191 mm  
Weight 1250gr

Code | 73772



Code | 72251



**GMDSS Handheld Radio Kit V100**

- Fully waterproof
- 21 simplex channels as standard
- Lithium primary battery for emergency use
- Lithium Polymer rechargeable battery with rapid charger for everyday normal use
- Superior battery life (typical operation >16h)
- Non-hazardous battery
- MED & FCC certified

Code | 72258

**GMDSS Handheld Radio V100**

- Fully waterproof
- 21 simplex channels as standard
- Lithium primary battery for emergency use
- Superior battery life (typical operation >16h)
- Non-hazardous battery
- MED & FCC certified

Code | 72257



**Maritime Survivor Locating Device M100**

Code | 72451

**Personal Locator Beacon PLB1**

Height 77 x Width 51 X Depth 32,5 mm  
Weight 116gr

Code | 72250



**Flotation Pouch for PLB1 (72250)**

Code | 74708

**AIS Alarm Box**

Code | 72308





Safety

Available only in certain countries



**First Aid Kit, for Fishing & Power Boats**

**It includes:**

- Zinc Oxide Plaster, non-sterile, 1.25cm x 5m (CE) (1pc)
- Box of sterile gauze compresses, 15cm x 15cm (CE) (1pc)
- Sterile pressure tourniquet (CE) (1pc)
- Non-sterile bandage, 5cm x 5m (CE) (1pc)
- Elastic bandage, non-sterile, 6cm x 4m (CE) (1pc)
- Non-sterile adhesive bandages (CE) (10pcs)
- Sterile gel for burns, Burnshield hydro gel blot (CE) (1pc)
- Triangular bandage, non-sterile (CE) (1pc)
- Isothermal blanket, non-sterile (CE) (1pc)
- Hemostat rubber, non-sterile (CE) (1pc)
- Alcohol tissues (Approval by the National Organization for Medicines of Greece) (4pcs)
- One-use gloves (CE) (4pcs)
- Scissors
- Plastic forceps (1pc)
- Safety pins (4pcs)
- First aid instructions
- Instructions manual

Code | 71022



**Marine First Aid Kit**

**It includes (SOLAS):**

- Anti-Angina preparations
- Anti-hemorrhagic preparations
- Anti-emetics
- Anti-diarrhoea preparations
- Analgesics – Antipyretics
- Analgesics – Anti-inflammatory
- Iodine
- Antiseptic hydro peroxide
- Burn preparations, Burnshield hydro gel blots (CE) (2pcs)
- Cannula for mouth to mouth resuscitation (CE)
- Elastic adhesive bandage, 6cm x 4m (CE)
- 2 Boxes of sterile gauze compresses, 15cm x 15cm (CE)
- 70gr Cotton
- 6 One-use gloves (6pcs)
- 20 Adhesive bandages, of different dimensions (CE) (20pcs)
- Sterile pressure tourniquet (CE)
- Adhesive sutures (CE)
- Sterile gauze with waster & vegetable oil for burns, 15x15cm (CE)
- Zinc Oxide Plaster 1.25cm x 5m (CE)
- Scissors
- Thermometer
- Syringes of 2.5ml & 5ml (2pcs)

Code | 71023



**First Aid Kit SOLAS 74, for Lifeboats - Liferafts**

Certified by the Ministry of Merchant Marine/Merchant Ships Directorate according to (a) the International Convention on the Safety of Life at Sea 1974 (SOLAS 74) and the 1983 amendments, (b) the Royal Decree 36/1967 and (c) the Presidential Decree 277/1997.

**Contents:**

Anti-Angina Preparations, Anti-Hemorrhagics Including Uterotonics, Anti-Acid Mucous Dressings, Anti-Emetics, Anti-Diarroeoals, Analgesic-Antipiretics, Analgesic-Anti-Inflammatory Preparation, Antiseptic Mercurochrom, Antiseptic Eau Oxygenee, Burn Preparation, Cannula for Mouth to Mouth Resuscitation, Adhesive Elastic Bandage, Sterile Gauze Compresses, Cotton Wool, Disposable Polyethylene Gloves, Adhesive Dressings, Sterile Compression Bandages, Adhesive Sutures, Sterile Gauze with Fatty Water and Vegetable Oils for Burns, Adhesive Tape, Scissors, Thermometer, Disposable Syringes 2.5ml - 5ml

Code | 71245



**First Aid Kit-Non SOLAS**

**Contents:**

- Anti-angina preparations
- Anti-emetics
- Analgesics – Antipyretics
- Analgesics – Anti-inflammatory preparation
- Antiseptic hydro peroxide
- Burn preparation
- Cannula for mouth to mouth resuscitation
- Adhesive elastic bandage
- Sterile gauze compresses
- Cotton
- Adhesive dressings
- Sterile pressure bandages
- Adhesive sutures
- Adhesive tape
- Sterile gauze with water & vegetable oils for burns
- Scissors

Code | 56880



An important and absolutely necessary part of the safety equipment, especially for commercial vessels, is signage. LALIZAS International Standard Signs can be used for indicating exits, directions, fire fighting and lifesaving equipment for the purpose of safe evacuation during emergencies and power failures. LALIZAS manufactures in-house all the International Standard Signs for indicating all of the above with the addition of custom-made signs, which meet all the present IMO specifications, using the highest quality material, in order to meet specific requirements.



- IMO Symbols on Self-Adhesive Photoluminescent Vinyl
- Safety Signs on Self-Adhesive Photoluminescent Vinyl
- Photoluminescent Direction Signs
- Fire Signs
- Fire Control Symbols to Resolution A654
- Fire Control Symbols to ISO 17631
- Low Location Lighting
- Prohibition Signs
- Mandatory Signs
- Hazard Signs & Diamonds
- ISPS Code Signs & Security Signs
- Deck & Engine Room Signs
- Galley Signs
- Accommodation Signs
- Combination Signs
- Training, Safety, Environmental & LALIZAS Posters
- Passenger Vessel and Terminal Building Signs
- Temporary Tie Tags
- Pipe Identification (In accordance BS 1710 & ISO 1472)



## Lifebuoy Lettering

## Low Location Lighting

PHOTOLUMINESCENT (PL) SYSTEM



- Full Pack Service
- Custom-made Production
- On-board Installation
- Test & Measurement Report



## Anchoring, Docking & Mooring



Windlasses & Accessories	65-79	Fenders	93-99
Chains	79-80	Fender Covers & Accessories	99-100
Anchors & Accessories	81-83	Dock Fenders	101
Swivels & Thimbles	83-84	Mooring & Marking Buoys	101-105
Mooring Ropes & Accessories	84-86	Boat Hooks	106-107
Mooring Springs	86	Boarding Ladders & Accessories	108-114
Bow Thrusters & Accessories	87-93	Platforms & Gangways	114-115

Your boat deserves the best protection!

The OCEAN Fenders product range can meet the needs for fenders and other accessories for boats up to 80 m. To gain complete maneuverability control of your boat, MAX POWER offers a wide variety of bow-stern thrusters.

With the installation of a Lofrans' windlass, "anchoring aweigh" is now easy and simple, by just pressing a switch.

At MARINA Stores you will also find anchors, chains, mooring ropes, buoys, gangways, boarding ladders and many more mooring accessories.



Construction	Stainless Steel	
	500 W	800 W
Motor size		
Power Supply (V)	12	12
Maximum Pull (kg)	630	700
Working Load (kg)	95	100
Amps at Working Load (A)	75	80
Line Speed at Working Load (m/min)	23	25
Max. Line Speed (m/min)	26	28
Net Weight Low Profile (kg)	11	13
Net Weight with Drum (kg)	12	14
Circuit Breaker (available separately)	636087	636088
Control Box	Included in the package	

SX1	CHAIN	Code	Code
Low Profile	6 mm, ISO 4565 / DIN 766	636279	636281
	8 mm, ISO 4565 / DIN 766	*	636280

## SX1 - Vertical Windlass

- Main features**
- Compact round base design
  - Marine AISI 316L stainless steel construction
  - Independent gypsy and drum operation
  - Manual chain release
  - Chain counter magnet pre-installed as standard
  - IP67 rated heavy-duty electric motor
  - Anodised marine aluminium gearbox
  - Chain pipe available as an option



**Combine with**  
LOFRANS' Gypsies  
page 78

\* Non-standard configuration. Optional gypsies can be supplied separately.

For further information, please visit [www.lofrans.com](http://www.lofrans.com)

Construction	Aluminium		Chromed bronze	
	500 W	500 W	800 W	1000 W
Motor size				
Power Supply (V)	12	12	12	12
Maximum Pull (kg)	630	630	700	900
Working Load (kg)	95	95	100	125
Amps at Working Load (A)	75	75	80	120
Line Speed at Working Load (m/min)	23	23	25	18
Max. Line Speed (m/min)	26	26	28	30
Net Weight Low Profile (kg)	10	11	13	16
Net Weight with Drum (kg)	11	12	14	17
Circuit Breaker (available separately)	187331	187331	187332	187333
Control Box	Included in the package			

X1	CHAIN	ROPE	Code	Code	Code	Code
With Drum	6 mm, ISO 4565 / DIN 766	10-12 mm, 3-strand	409558	472881	473207	*
	8 mm, ISO 4565 / DIN 766	12 mm, 3-strand	*	187270	473003	600092
Low Profile	6 mm, ISO 4565 / DIN 766	10-12 mm, 3-strand	409557	472880	473217	*
	8 mm, ISO 4565 / DIN 766	12 mm, 3-strand	*	187269	473002	600093

## X1 - Vertical Windlass

- Main features**
- Luxury chromed bronze base and drum
  - With drum or low profile
  - Independent gypsy and drum operation
  - Rope and chain combination gypsy
  - Manual chain release
  - Rope chain management by the spring loaded arm
  - Chain counter magnet pre-installed as standard
  - IP67 rated heavy-duty electric motor
  - Anodised marine aluminium gearbox



\* Non-standard configuration. Optional gypsies can be supplied separately.

For further information, please visit [www.lofrans.com](http://www.lofrans.com)



**Combine with**  
LOFRANS' Maintenance Kit  
page 77

Construction	Stainless Steel			
	1000 W		1500 W	
Motor size				
Power Supply (V)	12	24	12	24
Maximum Pull (kg)	1000	1060	1200	1270
Working Load (kg)	150	160	165	175
Amps at Working Load (A)	135	70	150	75
Line Speed at Working Load (m/min)	20	23	17	19
Max. Line Speed (m/min)	40	40	40	40
Net Weight Low Profile (kg)	19	23	24	24
Net Weight with Drum (kg)	20	24	25	25
Circuit Breaker (available separately)	636089	636088	636090	636088
Control Box	Included in the package			

SX2	CHAIN	Code	Code	Code	Code
With Drum	8 mm, ISO 4565 / DIN 766	636283	*	*	636285
Low Profile	8 mm, ISO 4565 / DIN 766	636282	*	*	636284

## SX2 - Vertical Windlass

- Main features**
- Compact round base design
  - Marine AISI 316L stainless steel construction
  - With drum or low profile
  - Independent gypsy and drum operation
  - Manual chain release
  - Chain counter magnet pre-installed as standard
  - IP67 rated heavy-duty electric motor
  - Anodised marine aluminium gearbox
  - Chain pipe available as an option



For further information, please visit [www.lofrans.com](http://www.lofrans.com)

\* Non-standard configuration. Optional gypsies can be supplied separately.



Anchoring, Docking & Mooring



**3**  
Years Limited  
Warranty  
\*

## X2 - Vertical Windlass

### Main features

- Luxury chromed bronze base and drum
- Special watertight stainless steel ball bearing in the base
- With drum or low profile
- Independent gypsy and drum operation
- Rope and chain combination gypsy
- Manual chain release
- Manual override available for chromed bronze models only
- Rope chain management by the spring loaded arm
- Chain counter magnet pre-installed as standard
- IP67 rated heavy-duty electric motor
- Anodised marine aluminium gearbox

Construction	Aluminium						Chromed bronze					
	700W	800W	1000 W		1500 W		700W	800W	1000 W		1500 W	
Motor size	24	12	12	24	12	24	24	12	12	24	12	24
Power Supply (V)	24	12	12	24	12	24	24	12	12	24	12	24
Maximum Pull (kg)	750	850	1000	1060	1200	1270	750	850	1000	1060	1200	1270
Working Load (kg)	105	115	150	160	165	175	105	115	150	160	165	175
Amps at Working Load (A)	45	90	135	70	150	75	45	90	135	70	150	75
Line Speed at Working Load (m/min)	26	26	20	23	17	19	26	26	20	23	17	19
Max. Line Speed (m/min)	35	35	40	40	40	40	35	35	40	40	40	40
Net Weight Low Profile (kg)	18	18	19	23	24	24	21	21	23	23	24	24
Net Weight with Drum (kg)	19	19	20	24	25	25	23	23	24	24	25	25
Circuit Breaker (available separately)	187331	187332	187333	187332	187333	187332	187331	187332	187333	187332	187333	187332
Control Box	Included in the package											

X2	CHAIN	ROPE	Code	Code	Code	Code	Code	Code	Code	Code	Code	Code	Code	Code
With Drum	6 mm, ISO 4565 / DIN 766	-	*	600044	600049	*	*	*	601022	600046	600997	*	*	*
	8 mm, ISO 4565 / DIN 766	14 mm, 3-strand	*	472735	472751	472750	600057	600061	601024	472862	473212	473255	*	*
	10 mm, DIN 766	-	*	*	*	*	*	601068	*	*	602096	473227	187274	187276
	10 mm, ISO 4565	-	*	*	600053	*	600056	600060	*	*	472863	*	601013	601044
Low Profile	6 mm, ISO 4565 / DIN 766	-	602111	600045	600050	*	*	*	601016	600047	600989	*	*	*
	8 mm, ISO 4565 / DIN 766	14 mm, 3-strand	*	472558	472557	*	*	601065	601018	472861	473213	600054	*	*
	10 mm, DIN 766	-	*	*	*	*	601055	601067	*	*	602097	473226	187273	601041
	10 mm, ISO 4565	14 mm, 3-strand	*	*	57450	*	601054	601066	*	*	472864	478642	601008	602529

\* Non-standard configuration. Optional gypsies can be supplied separately.

For further information, please visit [www.lofrans.com](http://www.lofrans.com)



**3**  
Years Limited  
Warranty  
\*

## SX3 - Vertical Windlass

### Main features

- Compact round base design
- Marine AISI 316L stainless steel construction
- With drum or low profile
- Independent gypsy and drum operation
- Manual chain release
- Chain counter magnet pre-installed as standard
- IP66 rated heavy-duty electric motor
- Anodised marine aluminium gearbox
- Chain pipe available as an option

For further information, please visit [www.lofrans.com](http://www.lofrans.com)

Construction	Stainless Steel		
	1500 W	1700 W	1700 W
Motor size	12	12	24
Power Supply (V)	12	12	24
Maximum Pull (kg)	1200	1600	1695
Working Load (kg)	165	200	215
Amps at Working Load (A)	150	180	90
Line Speed at Working Load (m/min)	17	14	15
Max. Line Speed (m/min)	40	32	32
Net Weight Low Profile (kg)	32	35	35
Net Weight with Drum (kg)	35	38	38
Circuit Breaker (available separately)	636089	636091	636088
Control Box	Included in the package		

SX3	CHAIN	Code	Code	Code
With Drum	10 mm, DIN 766	*	*	636288
	12 mm, ISO 4565 / 13mm, DIN 766	*	*	636287
Low Profile	10 mm, DIN 766	636289	*	*
	12 mm, ISO 4565 / 13mm, DIN 766	*	*	636286

\* Non-standard configuration. Optional gypsies can be supplied separately.

Combine with LOFRANS' Gypsies page 78

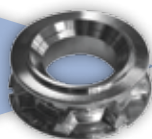



## X3 - Vertical Windlass

### Main features

- Luxury chromed bronze base and drum
- With drum or low profile
- Independent gypsy and drum operation
- Rope and chain combination gypsy

- Manual chain release
- Manual override available for chromed bronze models only
- Rope chain management by the spring loaded arm

- Chain counter magnet pre-installed as standard
- IP66 rated heavy-duty electric motor
- Anodised marine aluminium gearbox

Construction	Aluminium		Chromed bronze	
Motor size	1700 W	1500 W	1700 W	
Power Supply (V)	12	12	12	24
Maximum Pull (kg)	1600	1200	1600	1695
Working Load (kg)	200	165	200	215
Amps at Working Load (A)	180	150	180	90
Line Speed at Working Load (m/min)	14	17	14	15
Max. Line Speed (m/min)	32	40	32	32
Net Weight Low Profile (kg)	32	32	35	35
Net Weight with Drum (kg)	35	35	38	38
Circuit Breaker (available separately)	187334	187333	187334	187332
Control Box	Included in the package			

X3	CHAIN	ROPE	Code	Code	Code	Code
With Drum	8 mm, ISO 4565 / DIN 766	14 mm, 3-strand	57451	601079	600064	600068
	10 mm, DIN 766	16 mm, 3-strand	57452	473228	602101	602103
	10 mm, ISO 4565	16 mm, 3-strand	*	472865	473208	473252
Low Profile	12 mm, ISO 4565 / 13mm, DIN 766	18 mm, 3-strand	57453	601084	473004	473005
	8 mm, ISO 4565 / DIN 766	14 mm, 3-strand	601128	601070	600065	*
	10 mm, DIN 766	16 mm, 3-strand	*	*	602102	602104
	10 mm, ISO 4565	16 mm, 3-strand	601129	472866	473209	473256
	12 mm, ISO 4565 / 13mm, DIN 766	18 mm, 3-strand	*	601075	472842	473006

\* Non-standard configuration. Optional gypsies can be supplied separately.

## SX3.5 - Vertical Windlass

### Main features

- Luxury stainless steel base and drum
- With drum or low profile
- Independent gypsy and drum operation

- Manual chain release
- Chain counter magnet pre-installed as standard

- Anodised marine aluminium gearbox
- Heavy-duty electric motor
- Chain pipe available as an option

Construction	Stainless Steel				
Motor size	1700 W		2300 W	2700 W	Hydraulic - 8cc
Power Supply (V)	12	24	24	24	-
Maximum Pull (kg)	1700	1700	1900	2000	2500
Working Load (kg)	270	270	330	400	650
Amps at Working Load (A)	185	95	180	210	-
Line Speed at Working Load (m/min)	15	16	16	16	16
Max. Line Speed (m/min)	37	37	35	35	16
Net Weight Low Profile (kg)	50	50	60	60	55
Net Weight with Drum (kg)	48	48	58	58	60
Hydraulic Pressure (bar)	-	-	-	-	200
Hydraulic Flow (lt/min)	-	-	-	-	32
Circuit Breaker (available separately)	187334	187332	187333	187333	-
Control Box	Included in the package				

SX3.5	CHAIN	Code	Code	Code	Code	Code
With Drum	10 mm, DIN 766	600084	600085	602372	*	*
	12 mm, ISO 4565 / 13mm, DIN 766	600086	600087	600088	*	*
	14 mm	*	*	*	600090	*
Low Profile	12 mm, ISO 4565 / 13mm, DIN 766	635984	635985	635986	636099	*
	14 mm	*	*	*	*	636208

\* Non-standard configuration. Optional gypsies can be supplied separately.



For further information, please visit [www.lofrans.com](http://www.lofrans.com)



Combine with LOFRANS' Maintenance Kit page 77



For further information, please visit [www.lofrans.com](http://www.lofrans.com)



Anchoring, Docking & Mooring



Anchoring, Docking & Mooring

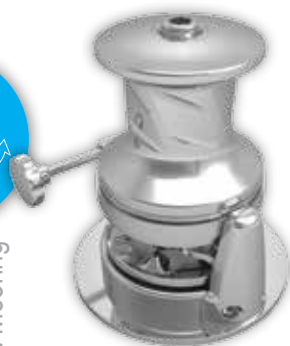

## SX4 - Vertical Windlass

### Main features

- Compact round base design
- Marine AISI 316L stainless steel construction
- With drum or low profile
- Independent gypsy and drum operation
- Manual chain release
- Chain counter magnet pre-installed as standard
- IP67 rated heavy-duty electric motor
- Anodised marine aluminium gearbox
- Chain pipe available as an option

\* Non-standard configuration. Optional gypsies can be supplied separately.

\*\*cw: the windlass pulls clockwise  
ccw: the windlass pulls counter clockwise

For further information, please visit [www.lofrans.com](http://www.lofrans.com)

Construction	Stainless Steel		
	2300 W	2700W	Hydraulic - 8cc
Motor size	2300 W	2700W	Hydraulic - 8cc
Power Supply (V)	24	24	-
Maximum Pull (kg)	2100	2500	2500
Working Load (kg)	500	530	650
Amps at Working Load (A)	160	170	-
Line Speed at Working Load (m/min)	13	13	16
Max. Line Speed (m/min)	25	28	16
Net Weight Low Profile (kg)	72	75	55
Net Weight with Drum (kg)	82	85	60
Hydraulic Pressure (bar)	-	-	200
Hydraulic Flow (lt/min)	-	-	32
Circuit Breaker (available separately)	636090	636091	-
Control Box	Included in the package		-

SX4	CHAIN	Type**	Code	Code	Code
With Drum	12 mm, ISO 4565 / 13mm, DIN 766	cw	636290	636291	636295
Low Profile	12 mm, ISO 4565 / 13mm, DIN 766	ccw	636292	639293	639294

Combine with LOFRANS' Maintenance Kit page 77



## X4 - Vertical Windlass

### Main features

- Luxury chromed bronze base and drum
- With drum or low profile
- Independent gypsy and drum operation
- Manual chain release
- Manual override
- Chain counter magnet pre-installed as standard
- Anodised marine aluminium gearbox
- Heavy-duty electric motor

\* Non-standard configuration. Optional gypsies can be supplied separately.

\*\*cw: the windlass pulls clockwise  
ccw: the windlass pulls counter clockwise

For further information, please visit [www.lofrans.com](http://www.lofrans.com)

Construction	Chromed bronze		
	2300 W	2700 W	Hydraulic - 8cc
Motor size	2300 W	2700 W	Hydraulic - 8cc
Power Supply (V)	24	24	-
Maximum Pull (kg)	2100	2500	2500
Working Load (kg)	500	530	650
Amps at Working Load (A)	160	170	-
Line Speed at Working Load (m/min)	13	13	16
Max. Line Speed (m/min)	25	28	16
Net Weight Low Profile (kg)	72	75	55
Net Weight with Drum (kg)	82	85	60
Hydraulic Pressure (bar)	-	-	200
Hydraulic Flow (lt/min)	-	-	32
Circuit Breaker (available separately)	187333	187334	-
Control Box	Included in the package		-

X4	CHAIN	Type*	Code	Code	Code
With Drum	10 mm, DIN 766	cw	600073	*	*
	12 mm, ISO 4565 / 13mm, DIN 766	cw	473007	600075	602361
	14 mm	cw	*	472849	602362
	12 mm, ISO 4565 / 13mm, DIN 766	ccw	600074	*	602363
	14 mm	ccw	*	*	602364
Low Profile	12 mm, ISO 4565 / 13mm, DIN 766	ccw	601142	601159	*



Construction	316 L Stainless Steel	
<b>Motor size</b>	<b>3000 W</b>	<b>Hydraulic - 8cc</b>
<b>Power Supply (V)</b>	<b>24</b>	<b>-</b>
<b>Maximum Pull (kg)</b>	2800	2500
<b>Working Load (kg)</b>	760	680
<b>Amps at Working Load (A)</b>	210	-
<b>Line Speed at Working Load (m/min)</b>	17	21
<b>Max. Line Speed (m/min)</b>	33	21
<b>Net Weight with Drum (kg)</b>	100	85
<b>Hydraulic Pressure (bar)</b>	-	200
<b>Hydraulic Flow (lt/min)</b>	-	32
<b>Control Box</b>	Included in the package	-

SX5	CHAIN	Type**	Code	Code
With Drum	10 mm, DIN 766	cw	<b>600089</b>	<b>602389</b>
	14 mm	cw	<b>600091</b>	<b>602390</b>
	14 mm	ccw	<b>636463</b>	*
Low Profile	12 mm, ISO 4565 / 13mm, DIN 766	cw	<b>636296</b>	*

Construction	316 L Stainless Steel		
<b>Motor size</b>	<b>3500 W</b>	<b>4000 W</b>	<b>Hydraulic - 8cc</b>
<b>Power Supply (V)</b>	24	230-400	-
<b>Maximum Pull (kg)</b>	4500	4500	5000
<b>Working Load (kg)</b>	825	850	1000
<b>Amps at Working Load (A)</b>	200	-	-
<b>Line Speed at Working Load (m/min)</b>	13	13	13
<b>Max. Line Speed (m/min)</b>	20	13	13
<b>Net Weight with Drum (kg)</b>	160	160	145
<b>Hydraulic Pressure (bar)</b>	-	-	200
<b>Hydraulic Flow (lt/min)</b>	-	-	32
<b>Circuit Breaker (available separately)</b>	Yes	-	-
<b>Control Box</b>	Included in the package	-	-

SX7	CHAIN	Type**	Code	Code	Code
With Drum	12 mm, ISO 4565 / 13mm, DIN 766	cw	<b>636459</b>	<b>636520</b>	<b>636526</b>
	14 mm	cw	<b>636518</b>	<b>636522</b>	<b>636524</b>
	12 mm, ISO 4565 / 13mm, DIN 766	ccw	<b>636464</b>	<b>636521</b>	<b>636527</b>
	14 mm	ccw	<b>636519</b>	<b>636523</b>	<b>636525</b>

\* Non-standard configuration. Optional gypsies can be supplied separately.

\*\*cw: the windlass pulls clockwise, ccw: the windlass pulls counter clockwise

## SX5 - Vertical Windlass

### Main features

- Luxury stainless steel base and drum
- Independent gypsy and drum operation
- Manual chain release
- Chain counter magnet pre-installed as standard
- Anodised marine aluminium gearbox
- Heavy-duty electric motor
- Chain pipe available as an option



\* Non-standard configuration. Optional gypsies can be supplied separately.

\*\*cw: the windlass pulls clockwise  
ccw: the windlass pulls counter clockwise



**For further information, please visit [www.lofrans.com](http://www.lofrans.com)**



**Combine with**  
LOFRANS' Gypsies  
page 78

## SX7 - Vertical Windlass



### Main features

- Luxury stainless steel base and drum
- Independent gypsy and drum operation
- Manual chain release
- Chain counter magnet pre-installed as standard
- Anodised gearbox suitable for marine use
- Available DC, AC and hydraulic motors
- Chain pipe included in the package

**For further information, please visit [www.lofrans.com](http://www.lofrans.com)**



Anchoring, Docking & Mooring



Anchoring, Docking & Mooring

**3**  
Years Limited  
Warranty



## ERCOLE VERTICALE - Vertical Windlass

### Main features

- Under-deck compact dimensions
- Construction in mirror polished AISI 316L stainless steel
- High torque latest generation electric motor able to provide the power needed in all marine conditions
- Band brake to assist in chain control, thanks to an easy-to-manage large hand-wheel
- Special high-grip drum with independent rotation from the gypsy, for warping function
- Independent gypsy and drum operation
- Manual chain release
- Manual override to recover the chain and anchor in case of electrical failure
- Internal ratchet to prevent chain jams into the chain cocker which could damage the deck
- Chain counter support integrated by the sensor inserted in the base and the magnet in the gypsy
- Available also in counter clockwise rotation
- High-efficiency Lofrans' planetary - worm screw gearbox made in anodised black aluminium with gears made in high mechanical strength material
- Heavy-duty electric motor
- Power: DC, AC and hydraulic
- Available in custom versions

Combine with  
LOFRANS' Gypsies  
page 78

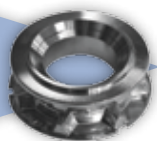

For further information,  
please visit  
[www.lofrans.com](http://www.lofrans.com)

Construction	316 L Stainless Steel				
	3500 W	4000 W	5500 W	7500 W	Hydraulic - 11cc
Motor size					
Power Supply (V)	24	230-400	230-400	400	-
Maximum Pull (kg)	4500	2200	6500	7500	6500
Working Load (kg)	705	565	1550	2000	1550
Amps at Working Load (A)	240	-	-	-	-
Line Speed at Working Load (m/min)	12	13	13	13	14
Max. Line Speed (m/min)	20	13	13	13	14
Net Weight with Drum (kg)	180	180	200	225	165
Hydraulic Pressure (bar)	-	-	-	-	200
Hydraulic Flow (lt/min)	-	-	-	-	40
Control Box	Included in the package	600096	600693	600699	-

ERCOLE VERTICALE	CHAIN	Type**	Code				Code
			Code	Code	Code	Code	
With Drum	14 mm	cw	600080	600082	*	*	602523
	16 mm	cw	*	*	600409	*	602525
	17,5 STUD LINK	cw	*	*	*	636078	
	14 mm	ccw	600081	600083	*	*	602524
	16 mm	ccw	*	*	600408	*	602526
	17,5 STUD LINK	ccw	*	*	*	636079	

\* Non-standard configuration. Optional gypsies can be supplied separately.

\*\*cw: the windlass pulls clockwise, ccw: the windlass pulls counter clockwise

**3**  
Years Limited  
Warranty



## ROYAL - Horizontal Windlass

### Main features

- Marine aluminium anodised body
- Independent gypsy and drum operation
- Manual chain release

For further information,  
please visit  
[www.lofrans.com](http://www.lofrans.com)

Construction	Anodised Aluminium	
	MANUAL	
Motor size		
Power Supply (V)		-
Maximum Pull (kg)		400
Working Load (kg)		50
Amps at Working Load (A)		-
Line Speed at Working Load (m/min)		-
Max. Line Speed (m/min)		-
Net Weight with Drum (kg)		10
ROYAL	CHAIN	Code
With Drum	6 mm, ISO 4565 / DIN 766	187323
	7 mm, ISO 4565	600625
	8 mm, ISO 4565 / DIN 766	404725
	10 mm, DIN 766	600079
	10 mm, ISO 4565	220002

**3**  
Years Limited  
Warranty



## DORADO - Horizontal Windlass

### Main features

- Marine aluminium anodised body
- Manual chain release
- Rope chain management by the spring load arm
- Heavy-duty rated IP66 electric motor
- Automatic free fall available as an option



## Stern Windlass Support, SS316, with Roller & Flange

Code | 72204

Construction	Anodised Aluminium			
	500 W	800 W		
Motor size				
Power Supply (V)	12	12		
Maximum Pull (kg)	630	900		
Working Load (kg)	95	125		
Amps at Working Load (A)	65	80		
Line Speed at Working Load (m/min)	18	20		
Max. Line Speed (m/min)	24	25		
Net Weight with Drum (kg)	10	11		
Circuit Breaker (available separately)	187331	187332		
Control Box	Included in the package			
DORADO	CHAIN	ROPE	Code	Code
Low Profile	6 mm, ISO 4565	10-12 mm, 3-strand	409568	600048
	8 mm, ISO 4565 / DIN 766	12 mm, 3-strand	*	409569

\* Non-standard configuration. Optional gypsies can be supplied separately.

For further information, please visit [www.lofrans.com](http://www.lofrans.com)





Construction	Anodised Aluminium	
Motor size	700 W	
Power Supply (V)	12	
Maximum Pull (kg)	575	
Working Load (kg)	105	
Amps at Working Load (A)	60	
Line Speed at Working Load (m/min)	23	
Max. Line Speed (m/min)	26	
Net Weight with Drum (kg)	11	
Control Box	Included in the package	

LION 1000	CHAIN	ROPE	Code
Low Profile	6 mm, ISO 4565	10-12 mm, 3-strand	636214
	8 mm, ISO 4565 / DIN 766	12 mm, 3-strand	636215
	6 mm, ISO 4565	10-12 mm, 3-strand	636216*
	8 mm, ISO 4565 / DIN 766	12 mm, 3-strand	636217*

\*with automatic free fall installed

## LION 1000 - Horizontal Windlass

### Main features

- Automatic free fall available (optional)
- White painted aluminium body
- Manual chain release
- Rope chain management by the spring load arm
- Chain counter magnet pre-setting as standard
- Heavy-duty rated IP66 electric motor
- Control box included in the package



For further information, please visit [www.lofrans.com](http://www.lofrans.com)



Anchoring, Docking & Mooring

Construction	Anodised Aluminium	
Motor size	1000 W	
Power Supply (V)	12	24
Maximum Pull (kg)	1250	1325
Working Load (kg)	170	170
Amps at Working Load (A)	150	80
Line Speed at Working Load (m/min)	16	17
Max. Line Speed (m/min)	32	33
Net Weight with Drum (kg)	21	21
Circuit Breaker (available separately)	187333	187332
Control Box	Included in the package	

KOBRA	CHAIN	Code	Code
With Drum	6 mm, ISO 4565 / DIN 766	600051	600513
	8 mm, ISO 4565 / DIN 766	220260	600514
	10 mm, ISO 4565	600052	471734
	10 mm, DIN 766	428747	220420

## KOBRA - Horizontal Windlass

### Main features

- Marine aluminium anodised body
- Independent gypsy and drum operation
- Manual chain release
- Manual override
- Heavy-duty rated IP66 electric motor
- Automatic free fall available as an option



For further information, please visit [www.lofrans.com](http://www.lofrans.com)

Construction	Anodised Aluminium		
Motor size	700 W	1000 W	
Power Supply (V)	12	12	24
Maximum Pull (kg)	1000	1250	1325
Working Load (kg)	100	170	170
Amps at Working Load (A)	110	150	80
Line Speed at Working Load (m/min)	21	16	17
Max. Line Speed (m/min)	32	32	33
Net Weight with Drum (kg)	24	25	25
Circuit Breaker (available separately)	187332	187333	187332
Control Box	Included in the package		

CAYMAN	CHAIN	Code	Code	Code
With Drum	6 mm, ISO 4565 / DIN 766	600043	*	*
	8 mm, ISO 4565 / DIN 766	220273	220279	*
	10 mm, ISO 4565	*	419732	*
	10 mm, DIN 766	*	600165	600180

\*Non-standard configuration. Optional gypsies can be supplied separately.

## CAYMAN - Horizontal Windlass

### Main features

- Marine aluminium anodised body
- Independent gypsy and drum operation
- Manual chain release
- Manual override
- Heavy-duty rated IP66 electric motor
- Automatic free fall available as an option



For further information, please visit [www.lofrans.com](http://www.lofrans.com)



Combine with LOFRANS' Maintenance Kit page 77



## TIGRES - Horizontal Windlass

### Main features

- Marine aluminium anodised body
- Independent gypsy and drum operation
- Manual chain release
- Manual override
- Heavy-duty rated IP66 electric motor
- Automatic free fall available as an option

For further information, please visit [www.lofrans.com](http://www.lofrans.com)

Construction	Anodised Aluminium	
<b>Motor size</b>	<b>1500 W</b>	
Power Supply (V)	12	24
Maximum Pull (kg)	1500	1590
Working load (kg)	190	200
Amps at Working Load (A)	160	90
Line Speed at Working Load (m/min)	14	16
Max. Line Speed (m/min)	33	33
Net Weight with Drum (kg)	28	28
Circuit Breaker (available separately)	187333	187332
<b>Control Box</b>	Included in the package	

TIGRES	CHAIN	Code	Code
With Drum	8 mm, ISO 4565 / DIN 766	418407	418409
	10 mm, ISO 4565	600055	600059
	10 mm, DIN 766	470060	220290



## FALKON - Horizontal Windlass

### Main features

- Marine aluminium anodised body
- Independent gypsy and drum operation
- Manual chain release
- Manual override
- Heavy-duty rated IP66 electric motor

For further information, please visit [www.lofrans.com](http://www.lofrans.com)

Construction	Anodised Aluminium	
<b>Motor size</b>	<b>1700 W</b>	
Power Supply (V)	12	24
Maximum Pull (kg)	1700	1800
Working Load (kg)	215	225
Amps at Working Load (A)	210	100
Line Speed at Working Load (m/min)	14	15
Max. Line Speed (m/min)	33	33
Net Weight with Drum (kg)	55	55
Circuit Breaker (available separately)	187334	187332
<b>Control Box</b>	Included in the package	

FALKON	CHAIN	Code	Code
With Drum	10 mm, ISO 4565	600063	600067
	10 mm, DIN 766	220293	418511
	12 mm, ISO 4565 / 13mm, DIN 766	404732	404733

Combine with LOFRANS' Maintenance Kit page 77



## TITAN - Horizontal Windlass

Construction			Anodised Aluminium		White Aluminium	Anodised Aluminium
<b>Motor size</b>			<b>2300W</b>	<b>3600W</b>	<b>3600W</b>	<b>Hydraulic - 9cc</b>
Power Supply (V)			24	230-1PH	230-1PH	-
TITAN	CHAIN	Model	Code	Code	Code	Code
With drum	12 mm, ISO 4565 / 13mm, DIN 766	Type A	404724	*	600846	602423
			600072	600847	*	602424
	12 mm, ISO 4565 / 13mm, DIN 766	Type B	428938	*	*	602468
			426415	*	*	602469

For further information, please visit [www.lofrans.com](http://www.lofrans.com)



## ERCOLE - Horizontal Windlass

Construction			White Aluminium	
<b>Motor size</b>			<b>3500W</b>	<b>Hydraulic - 11cc</b>
Power Supply (V)			24	-
ERCOLE	CHAIN	Model	Code	Code
With drum	14 mm	Type A	403615	602509
		Type B	220317	602512
		Type C	403614	602515

For further information, please visit [www.lofrans.com](http://www.lofrans.com)



**SUPER ERCOLE – Horizontal Windlass**

Construction	White Aluminium		
Motor size	3500W	5500W	Hydraulic - 11cc
Power Supply (V)	24	400	-

SUPER ERCOLE	CHAIN	Model	Code	Code	Code
With drum	16 mm	Type A	404957	602501	602488
		Type B	426414	602504	602491



**Combine with**  
LOFRANS' Gypsies  
page 78

For further information, please visit [www.lofrans.com](http://www.lofrans.com)

**T500 - T700 - T1000 - T1500-T1700 CAPSTANS**

Construction	Chromed bronze									
Model	T500	T700		T1000		T1500		T1700		
Motor size	500 W	700 W		1000 W		1500 W		1700 W		
Power Supply (V)	12	12	24	12	24	12	24	12	24	
Code	409130	220006	418159	417946	187324	220014	418161	472407	187326	

Construction	Aluminium									
Model	T500	T700		T1000		T1500		T1700		
Motor size	500 W	700 W		1000 W		1500 W		1700 W		
Power Supply (V)	12	12	24	12	24	12	24	12	24	
Code	409563	411129	600779	409564	409567	600058	600062	600066	600069	



For further information, please visit [www.lofrans.com](http://www.lofrans.com)

**ST1000 - ST1500 - ST1700 CAPSTANS**

Model	ST1000	ST1500	ST1700
Motor size	1000 W	1500 W	1700 W
Power Supply (V)	24	24	24
Code	636297	636298	636299



Stainless Steel

For further information, please visit [www.lofrans.com](http://www.lofrans.com)

**T2000 - T2500 CAPSTANS**

Construction	Chromed bronze			
Model	T2000			
Motor size	2200 W	2300 W		Hydraulic - 9cc
Type**	CW	CW	CCW	CW
Power Supply (V)	400	24	24	-
Code	600071	404967	600729	602140

Construction	Chromed bronze			
Model	T2500			
Motor size	2200 W	2700 W	Hydraulic - 9cc	
Type	CW	CW	CW	
Power Supply (V)	400	24	-	
Code	600070	476239	602168	



\*\*cw: the capstan pulls clockwise ccw: the capstan pulls counter clockwise

For further information, please visit [www.lofrans.com](http://www.lofrans.com)



Anchoring, Docking & Mooring



Anchoring, Docking & Mooring



Stainless Steel

## ST2000 - ST2500 CAPSTANS

Model	ST2500		
Motor size	2300 W		
Type**	CW		CCW
Power Supply (V)	24		24
Code	636300		636301

Model	ST2500		
Motor size	2200 W	2700 W	Hydraulic - 9cc
Type	CW	CW	CW
Power Supply (V)	230-400	24	-
Code	636302	636303	636304

Marine AISI 316L Stainless Steel base & drum

For further information, please visit [www.lofrans.com](http://www.lofrans.com)



## ST3000 - ST4000 CAPSTANS

Model	ST3000			
Motor size	2200 W	3000 W	3600 W	Hydraulic - 9cc
Power Supply (V)	230-400	24	24	-
Code	600767	602187	602196	602189



Model	ST4000		
Motor size	3500 W	4000 W	5000 W
Power Supply (V)	24	230-400	230-400
Code	600077	600771	423284

For further information, please visit [www.lofrans.com](http://www.lofrans.com)



## CETO RECOVERY CAPSTANS

Construction	Marine anodised aluminum		
Motor size	1000 W		
Power Supply (V)	12		
Code	635999		

For further information, please visit [www.lofrans.com](http://www.lofrans.com)



## TENDER WINCH RECOVERY CAPSTANS

Construction	Marine anodised aluminum		
Motor size	500 W	800 W	700 W
Power Supply (V)	12	12	24
Code	030054	602122	602123

For further information, please visit [www.lofrans.com](http://www.lofrans.com)



**Chain Stopper, Inox,  
for ISO/DIN Chain  
8/10/12mm**

Code | 636257



**Chain Stopper, Inox,  
for ISO/DIN Chain  
12/13/14/16mm**

Code | 72191

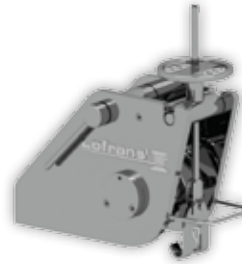

**Chain Roller-Stopper  
with Tensioner, Inox, for  
ISO/DIN/Studlink Chain  
14/16mm**

Code | 72192



Anchoring, Docking & Mooring

**Chain Pipe for SX Series**

**Main features**

- Ensuring the smooth movement of the chain from and to the chain locker
- Marine AISI 316 stainless steel construction
- Mirror-polished finish
- Iconic Italian design
- Compatible with our SX series

Code	636431	636311	636312	636313	636314
Windlass	<b>SX1</b>	<b>SX2 &amp; SX3</b>	<b>SX3,5</b>	<b>SX4</b>	<b>SX5</b>

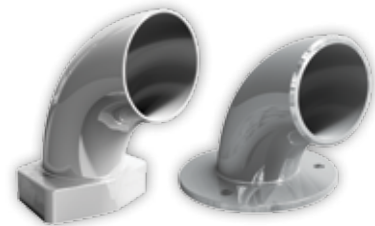

Code	73633
Command transmission	Remote
Number of button	3 (Transmitter)
Voltage	12 - 24Vdc (Receiver)
Operative temperature	-10 : +60
IP protection rated*	66 (Transmitter)
Max contacts amperage (A)	2 (Receiver)
Weight (gr)	480
Dimension (mm)	155x65x45 (Transmitter)

**Radio Control Chain Counter THETIS 7003**

Without cable ties, plug or panels and with load always perfect by its rechargeable battery, the radio chain counter THETIS 7003 gives finally all the freedom of manoeuvres and the comfort of reading in the anchoring operations. Reinforced covers & buttons.

- Chain speed indicator / mooring length in meters or feet
- Voltage indicator
- Up alarm sensor
- Switch on button / Key tones adjustment
- High vision LCD display / Backlit display screen / Eight level of contrast
- Six language menu (IT, EN, FR, DE, ES, GR)
- Able to control free fall windlasses
- Parallel connection
- USB cable and charger included
- Cradle included

\*When installed

**THETIS 7003**



Cradle

Code	73632
Command transmission	Wire
Number of button	3
Voltage	12 - 24Vdc
Operative temperature	-10 : +60
IP protection rated*	66
Max contacts amperage (A)	2
Weight (gr)	710
Dimension (mm)	155x65x45

**Hand Held Remote Control Chain Counter THETIS 5003**

This remote chain counter model, THETIS 5003, has been specifically designed to give the full control in anchoring. It is a reliable and practical instrument, technologically advanced, specifically design for use in marine environments. The external casing, rated with IP66 and supplied with waterproof plug and socket rated IP67. The extending flexible cable (approximately 4 metres) gives the maximum freedom on board during anchoring manoeuvring. Provided with an evolved microprocessor that offers a series of advantages for full control of the anchoring. Reinforced covers & buttons.

- Chain speed indicator / mooring length in meters or feet
- Voltage indicator
- Up alarm sensor
- Switch on button / Key tones adjustment
- High vision LCD display / Backlit display screen / Eight level of contrast
- Six language menu (IT, EN, FR, DE, ES, GR)
- Able to control free fall windlasses
- Parallel connection
- Cradle included

**THETIS 5003**



Cradle

\*When installed

## THETIS 1002



Cradle



### Hand Held Control THETIS 1002

This hand held remote control model, THETIS 1002, has an elegant and functional design. The soft rubber case, which covers sideways the remote control, allows a safe and handy taking under any condition. This hand held remote control is rated with IP66 and supplied with waterproof plug and socket rated IP67. The extending flexible cable (approximately 4 metres) gives the maximum freedom on board during anchoring manoeuvring. Reinforced covers & buttons.

- Inversion polarity protection
- Parallel connection
- 2 buttons (up-down)
- Cradle included

\*When installed

Code	73631
Command transmission	Wire
Number of button	2
Voltage	12 - 24Vdc
Operative temperature	-10 : +60
IP protection rated*	66
Max contacts amperage (A)	2
Weight (gr)	580
Dimension (mm)	155x65x45

Anchoring, Docking & Mooring

## IRIS II



### Panel Chain Counter IRIS II

This fly bridge chain counter, IRIS II, is technologically advanced instrument with an elegant and ergonomic design makes it suitable for all type of boat cockpits. IRIS II is supplied with an evolved microprocessor, with different operations allowing an optimum anchoring. New larger display.

- Chain speed indicator / mooring length in meters or feet
- Voltage indicator
- Up alarm sensor
- Switch on button / Key tones adjustment
- High-vision LCD display 3" / Backlit display screen / Eight level of contrast
- Six language menu (IT, EN, FR, DE, ES, GR)
- Able to control free fall windlasses
- Parallel connection

\*When installed

Code	600017
Command transmission	Wire
Number of button	3
Voltage	12 - 24Vdc
Operative temperature	-10 : +60
IP protection rated*	67
Max contacts amperage (A)	2
Weight (gr)	500
Dimension (mm)	110x105x15 (5 flat version)

new



### Touch Panel Up Down, Black

Lofrans' Touch Panel up down is a low profile anchor windlass touch panel with LED backlit buttons. It is designed with safety in mind, having a two button activation mode in order to secure any accidental activation. Its secure design is enhanced by the 3 minute auto deactivation as well as the buzzer notification on deactivation. The round back flange plays a key role to the easy installation on board. It comes in elegant black colour. IP67 water/dust rating (front panel). A truly reliable windlass control panel.

Code	74317
Colour	Black
Compatible with	All Windlasses
Dimensions (mm)	65 x 65



### Mini Remote Control

Lofrans' Mini Radio Remote Control is designed to work with our range of windlasses. The remote control can also be used to operate other onboard equipment such as thrusters, passerelles, cranes, etc.

- Easy to install and set-up, simple to use
- Small form factor makes it ideal to carry it anywhere on-board.
- Supports up to 4 independently control channels (12/24V - 10A)
- Zero power consumption when in standby (transmitter)
- Transmitter rated IP67

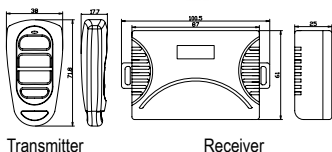

Transmitter

Receiver

Code	636305
Description	Transmitter & Receiver (EU/USA)
Frequency	433 MHz
Number of button	4
Voltage	12 - 24V (Receiver) 3V (Transmitter)
Operative temperature	-10 : +60
IP protection rated	IP 67
Max contacts amperage (A)	10
Weight (gr)	31 (Transmitter) / 95 (Receiver)
Dimension (mm)	71,8x38x17,7 (Transmitter) / 100,5x61x25 (Receiver)



**Radio Remote Control**

Lofrans' Radio Remote Control is designed to work with our range of windlasses. The remote control can also be used to operate other onboard equipment such as thrusters, passerelles, cranes, etc.

- Transmitter rated IP67
- Supports up to 8 independently controlled channels
- Each receiver can switch 4 channels (12/24 V - 2 A)
- Each transmitter can handle 2 receivers (8 channels)
- Digital recognition avoids accidental activation of other system
- Zero power consumption when in standby mode (transmitter)
- Easy to install and set-up, simple to use

<b>Code</b>	<b>312976</b>	<b>312977</b>
<b>Description</b>	Transmitter & Receiver (EU)	Transmitter & Receiver (USA)
<b>Frequency</b>	868 MHz	915 MHz
<b>Number of button</b>	8 (Transmitter)	
<b>Voltage</b>	12 - 24Vdc (Receiver)	
<b>Operative temperature</b>	-10 : +60	
<b>IP protection rated</b>	67 (Transmitter)	
<b>Max contacts amperage (A)</b>	2 (Receiver)	
<b>Weight (gr)</b>	310	
<b>Dimension (mm)</b>	114x60x22(transmitter) / 126x78x23(receiver)	



Anchoring, Docking & Mooring

**Foot switch**

This device is an easy-to-install switch which works simply by pushing the foot on the button. The base is made of stainless steel while the cover is made of composite material to prevent accidental engagement. The button is made of special marine rubber, able to withstand UV rays and the marine environment. Available in UP and DOWN versions.

<b>Code</b>	<b>636075</b>	<b>636074</b>	<b>600012</b>	<b>600011</b>	<b>602121</b>
<b>Description</b>	Black / Inox	Red / Inox	Black / Grey	Red / Grey	Blue / WASH DOWN
<b>Voltage</b>	12-24Vdc				
<b>Operative temperature</b>	-10 : +60				
<b>IP protection rated</b>	67				
<b>Max contacts amperage (A)</b>	5				
<b>Weight (gr)</b>	250		100		
<b>Dimension (mm)</b>	80x95x20				



**Control Switch –Type L**

This switch, usually installed on the cockpit, is made of a fixing plaque and a three-position switch (Up-Off-Down).

Code | 404728



**Control Switch –Type C**

This rocker switch has a modern and practical design. It is reliable, watertight and supplied with the apposite case for simple and safe installation.

Code | 187338



<b>Code</b>	<b>For WINDLASS</b>
72036	X0
72037	X1
72038	X2 & PROJECT 1000
72039	X2 ALU
72040	X3, X3 ALU & PROJECT 1500
72046	ROYAL
72047	DORADO
72048	KOBRA & CAYMAN
72050	TIGRES
72051	FALKON
72045	ATLAS

**Maintenance Kit**

Every Lofrans' windlass has its own maintenance kit in order to remain as good as new. You can choose the proper one according to the exploded diagram.

**KEEP YOUR LOFRANS' AS GOOD AS NEW!**



Exploded Diagram



Anchoring, Docking & Mooring

## Gypsies



### For Vertical Windlasses

For windlass	Chain Size	Gypsy Code
X1 & SX1	6mm ISO4565/DIN766	630970
	7mm ISO4565 - 1/4" G40	630980
	8mm ISO4565/DIN766	630999
X2 & SX2	6mm ISO4565/DIN766	630953
	8mm ISO4565/DIN766	630949
	10mm ISO4565	630951
	10mm DIN766	630955
X3 & SX3	8mm ISO4565/DIN766	630957
	10mm ISO4565	630951
	10mm ISO4565	630959
	10mm DIN766	630966
SX3.5	12mm ISO4565 - 13mm DIN766	630961
	10mm DIN766	631026
	10-3/8 HT (NICHELATO)	631024
	10mm ISO4565 3/8" HT	636570
	12-13mm DIN766	636573
X4 & SX4	12-13mm DIN766	636572
	14 mm	631074
	3/8" G40	631124
	7/16" HT	630992
	1/2" G40	631036
	10mm DIN766 3/8" BBB	631132
	10mm ISO4565 3/8" HT	636570
	12-13mm DIN766	636572
SX5	13mm DIN764	631050
	14mm	631059
	1/2" STUDLINK	631053
	12-13mm DIN766	631042
Ercole Vertical	14mm	631065
	14 STUDLINK	631071
	1/2" STUDLINK	631053
	12-13mm DIN766	631039
	13 ITALMET	631056
	13mm DIN764	631085
	14mm	631065
	14 STUDLINK	631068
	14,5 UNI4417	630989
	16mm ISO4565	631082
Project 1000	16mm DIN766	631088
	16 STUDLINK	631092
	18 STUDLINK	631098
	18mm ISO4565	631101
Project 1500	6mm ISO4565/DIN766	630953
	8mm ISO4565/DIN766	630949
	10mm ISO4565	630951
	10mm DIN766	630955
Project 2000	8mm ISO4565/DIN766	630957
	10mm ISO4565	630951
	10mm DIN766	630959
	12mm ISO4565 - 13mm DIN766	630961
Project 1000	5/16" HT	631129
	7/16" HT	630992
	1/2" G40	631036
	10mm DIN766 - 3/8" BBB	631132
	10mm ISO4565 - 3/8" HT	631022
	12-13mm DIN766	631031
Project 1500	14mm	631059
	5/16" HT	631129
	7/16" HT	636571
	1/2" G40	631036
	8mm ISO4565/DIN766	630996
	10mm ISO4565-3/8 HT	636570
	10mm DIN 766 - 3/8" BBB	631132
	12-13mm DIN766	636572
	3/8" G40	631124
	1/2" G40	631036
Project 2000	10mm ISO4565 - 3/8" HT	631022
	12-13mm DIN766	631031
	14mm	631059
	5/8" HT	630986
	12-13mm DIN766	631039
	14mm	631065
	16mm ISO4565	631082
	16mm DIN766	631088
	16 STUDLINK	631092
	18mm DIN766	631095
Project 1500	18 STUDLINK	631098
	18mm ISO4565	631101
	19 STUDLINK	631104
	1/2" STUDLINK	631053
	12-13mm DIN766	631039
	13 ITALMET	631056
	14mm	631065
	16mm ISO4565	631082
	16mm DIN766	631088
	16 STUDLINK	631092
Project 2000	18 STUDLINK	631098
	18mm ISO4565	631101

### For Horizontal Windlasses

For windlass	Chain Size	Gypsy Code
Royal	5/16" HT	631077
	3/8" BBB	631120
	3/8" PC	631122
	6mm ISO4565/DIN766	630968
	7mm ISO4565 - 1/4" G40	630978
	8mm ISO4565/DIN766	630994
LION 1000	10mm ISO4565 - 3/8" HT	631011
	10mm DIN766	631118
	6mm ISO4565/DIN766	631005
	7mm ISO4565	631007
Dorado	8mm ISO4565/DIN766	631009
	6mm ISO4565/DIN766	630974
	7mm ISO4565 - 1/4" G40	630984
	8mm ISO4565/DIN766	631003
Cayman	Only ROPE gypsy	634877
	5/16" HT	631077
	3/8" BBB	631120
	3/8" PC	631122
Kobra	6mm ISO4565/DIN766	630968
	7mm ISO4565 - 1/4" G40	630978
	8mm ISO4565/DIN766	630994
	10mm ISO4565 - 3/8" HT	631011
	10mm DIN766	631118
	5/16" HT	631077
Tigres	3/8" BBB	631120
	3/8" PC	631122
	6mm ISO4565/DIN766	630968
	7mm ISO4565-1/4" G40	630978
	8mm ISO4565/DIN766	630994
	10mm ISO4565 - 3/8 HT	631011
Falcon	10mm DIN766	631118
	12mm ISO4565 - 13mm DIN766	631028
	5/16" HT	631129
	7/16" HT	636571
	1/2" G40	631036
	8mm ISO4565/DIN766	630996
Titan	10mm ISO4565-3/8 HT	636570
	10mm DIN 766 - 3/8" BBB	631132
	12-13mm DIN766	636572
	3/8" G40	631124
	1/2" G40	631036
	10mm ISO4565 - 3/8" HT	631022
Super Ercole	10mm DIN766 - 3/8" BBB	631132
	12-13mm DIN766	631031
	14mm	631059
	5/8" HT	630986
	12-13mm DIN766	631039
	14mm	631065
	16mm ISO4565	631082
	16mm DIN766	631088
	16 STUDLINK	631092
	18mm DIN766	631095
Ercole Horizontal	18 STUDLINK	631098
	18mm ISO4565	631101
	19 STUDLINK	631104
	1/2" STUDLINK	631053
	12-13mm DIN766	631039
	13 ITALMET	631056
	14mm	631065
	16mm ISO4565	631082
	16mm DIN766	631088
	16 STUDLINK	631092
18 STUDLINK	631098	
18mm ISO4565	631101	

### Chain Identification

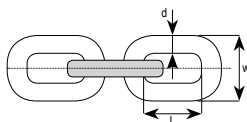

CHAIN d	Inside Length L (mm)	Outside Width w (mm)
6 ISO	18	20
7 ISO	21	24
8 ISO	24	27
10 ISO	30	34
12 ISO	36	40
14 ISO	42	47
6 DIN 766	18.5	20
7 1/4" DIN 766	22	23
8 - 5/16" DIN 766	24	26
10 - 3/8" DIN 766	28	34
13 - 1/2" DIN 766	36	44





## Winch Handles, Floating

- Floating if dropped overboard
- Designed to operate efficiently with the minimum effort required
- Durable, lightweight & easy to handle
- With locking mechanism
- Glass reinforced PA

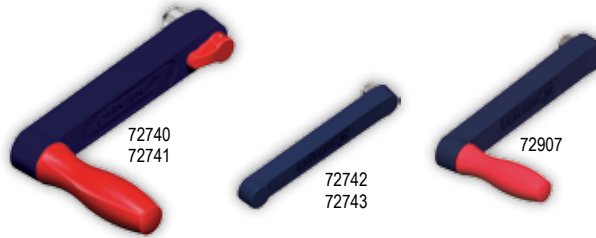

Code	Description	Length (cm)
72740	with lock	20
72741		25
72742	without lock & without handle	20
72743		25
72907	without lock	25



## Winch Handles, Anodised Aluminium

- Designed to operate efficiently with the minimum effort required
- Durable, lightweight & easy to handle
- Available options with speed handle
- With upgraded locking feature to ensure lock & unlock position. This increases the mechanism's lifetime, by protecting it from unintentional damage during use.
- Black Anodised Aluminium

Code	Description	Length (cm)
11856	with lock	20
11857	with lock & speed handle	
11860	with lock	25
11861	with lock & speed handle	

**new**

## Winch Handles, Glass Reinforced PA

- Designed to operate efficiently with the minimum effort required
- Durable, lightweight & easy to handle
- With upgraded locking feature to ensure lock & unlock position. This increases the mechanism's lifetime, by protecting it from unintentional damage during use.
- Glass Reinforced PA

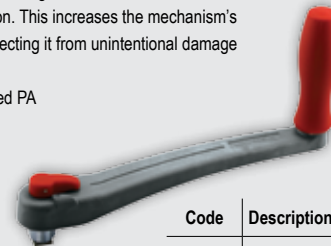

Code	Description	Length (cm)
74611	with lock	20
74612		25

Anchoring, Docking & Mooring

## Chains

### Hot Dip Galvanized Chain, G40, Calibrated

#### Main features

- Steel grade 40
- Hot Dip Galvanized
- Extended quality testing
- Certificate of Analysis for every drum included
- Lofrans' Authenticity Check "LFR"

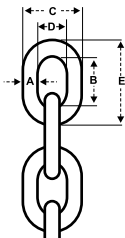

Code	72312	72313	72314	72315	72316	72408	72409
Type	ISO 4565 / DIN 766	ISO 4565 / DIN 766	DIN 766	ISO 4565	ISO 4565	DIN 766	
A (mm)	6	8	10	10	12	14	16
B (mm)	18,5	24	28	30	36	41,5	45
C (mm)	20	27,5	34	34,5	39,6	47,4	54,6
D (mm)	8	11,5	14	14,5	15,6	19,4	22,6
E (mm)	30,5	40	48	50	60	69,5	77
Weight / m (kg)	0,8	1,42	2,2	2,14	3,23	4,37	5,72
Breaking load (kg)	2400	4300	6750	6750	9700	13230	17280

Code	72749	72750	72751	72752	72753	72754	72755
Type	ISO 4565 / DIN 766		ISO 4565 / DIN 766		ISO 4565		ISO 4565
A (mm)	6		8		10		12
B (mm)	18,5		24		30		36
C (mm)	20		27,5		34,5		39,6
D (mm)	8		11,5		14,5		15,6
E (mm)	30,5		40		50		60
Weight / m (kg)	0,8		1,42		2,14		3,23
Breaking Load (kg)	2400		4300		6750		9700
Bag (m)	30	50	30	50	30	50	50



# Chains



Galvanized

## Hot Dip Galvanized Chain, DIN5685A, Genovese

Code	72060	72061	72062	72063
A (mm)	5	7	10	13
B (mm)	21	28	40	52
C (mm)	20	28	40	52
D (mm)	10	14	20	26
E (mm)	31	42	60	78
Breaking load (kg)	775	1500	3100	5300
Weight / m (kg)	0,5	1	2,05	3,45

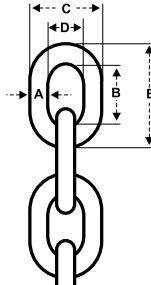

Inox 316

## Chain, Inox 316, Calibrated

Code	98042	98043	98044	98045	95637	97703
Type	ISO 4565 / DIN 766					
A (mm)	2	3	4	5	6	8
B (mm)	12	15	20		18,5	24
C (mm)	7,5	11	13	16	20	26
D (mm)	3,5	5	5	6	8	10
E (mm)	16	21	28	30	30,5	40
Weight / m (kg)	0.07	0.16	0.32	0.5	0.78	1.4
Breaking load (kg)	127	408	816	1,275	1,632	3,265

Anchoring, Docking & Mooring



## Marine Bucket, Black

Code	72059
Capacity (lt)	7,5
Material	rubber



## "D" Shackle, Large, Galvanized

Code	99229	98506	98507	98557	98558	98508	98509
Diam. (mm)	5	6	8	10	12	14	16

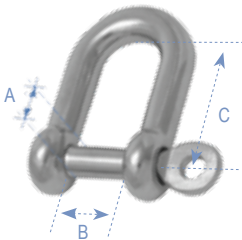

## "D" Shackle, Inox 316

\*Surface : E.P, Body: Casting, Pin: Forging

Code	90432	91189	91190	96694	91191	96881	91192	91193	91194	91195	91196
Size(mm)	4	5	6	7	8	9	10	12	13	14	16
A(mm)	4	4,8	5,8	6,8	7,8	8,8	9,8	11,8	12,8	13,8	15,8
B(mm)	8	10	12	14	16	18	20	24	26	28	32
C(mm)	16	20,21	24,25	28,37	32,48	36,66	40,8	49,27	53,68	57,97	66,7
Working load (kg)	55	80	100	150	200	260	320	520	580	660	800

## Anchor Shackle, Type Q

Surface : E.P

Code	99414	99415	99416	99417	99418	99421
Size(mm)	5	6	8	10	12	16
A(mm)	5	6	8	10	12	16
B(mm)	10	12	16	20	24	32
C(mm)	20,5	30	41	51	61	82



## Inox 316 Surface : E.P, Body: Casting, Pin: Forging

Code	90433	91200	91201	91202	91203	91204	91205	91206	91207
Size(mm)	4	5	6	8	10	12	13	14	16
A(mm)	4	4,8	5,8	7,8	9,8	11,8	12,8	13,8	15,8
B(mm)	8	10	12	16	20	24	26	28	32
C(mm)	18	22,5	27	36	45	54	58,5	63	72
Working load (kg)	55	80	100	200	320	520	580	660	800

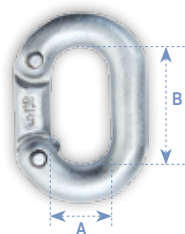

## Chain Connector, Galvanized

Code	99393	99394	99395
Size (mm)	6	8	10
A (mm)	11	12,7	14
B (mm)	22	25	28

new



## Chain Connector, Kenter Type, Black

Code	74310	74311	74312	74313	74314	74315	74316
Diameter (mm)	12,5	14	16	17,5	19	20,5	22



Anchoring, Docking & Mooring



**Anchor, Bruce Type, Inox 316**

Code	Weight (Kg)	For Max Boat Length (ft)
92246	2	18
92247	3	20
92248	5	25
92249	7,5	30
92250	10	35
92251	15	40
92252	20	50
72092	25	60
72093	30	65
72094	40	90
72095	50	120



**Anchor, Bruce Type, Hot-dipped Galvanized**

Code	Weight (Kg)	For Max Boat Length (ft)
92240	2	18
99207	3,5	20
92241	5	25
92242	7,5	30
92243	10	35
92244	15	40
92245	20	50
72084	25	60
72085	30	65
72086	50	75
72087	80	90



**Anchor, Delta Type, AISI 316**

Code	Weight (kg)	For Max Boat Length (ft)
99425	6	22
99426	8	30
99427	10	35
99428	15	40
99429	20	50
72096	25	60
99430	30	65
72097	40	75
72098	50	90
72099	80	120



**Anchor, Delta Type, Galvanized**

Code	Weight (kg)	For Max Boat Length (ft)
99476	6	25
99478	8	30
99479	10	35
99480	15	40
99481	20	50
72088	25	60
99482	30	65
72089	40	75
72090	50	90
72091	80	120



**Folding Anchor, Type A, Hot-dipped Galvanized**

Code	Weight (Kg)
92277	1,5
92278	2,5
92279	3,2
92280	4
92281	6
92282	8



**Folding Anchor, Type A, Inox 316**

Code	Weight (Kg)
92286	0,7
92287	1,5
92288	2,5
92289	4



**Plough Anchor, CQR Type, Inox 316**

Code	Weight (Kg)
92272	7
92273	9
92274	12
92275	15



**Plough Anchor, CQR Type, Hot-dipped Galvanized**

Code	Weight (Kg)
92264	7
92265	9
92266	12
92267	15
98466	22

**Combine with**  
Rope for chain rode use  
page 84



**Folding Anchor, Type B, Hot-dipped Galvanized**

Code	Weight (Kg)
92276	0,7
92283	10
92284	12
92285	15



**Hall Anchor, Type C, Hot-dipped Galvanized**

Code	Weight (Kg)
98888	2,8
98889	4
98890	6
98891	8



**Anchor, Danforth Type, Hot-dipped Galvanized**

Code	Weight (Kg)
92253	3
92254	5
92255	8
92256	10
92257	12
92258	14
98465	20

## Grapnel Anchor, Inox 304



Code	Weight (Kg)
92293	0,4
92294	0,95
92295	1,85
99433	2,5
99434	4



## Grapnel Anchor, Galvanized

Code	Weight (Kg)	Code	Weight (Kg)
70964	1	70966	15
92290	3	70967	18
92291	4	70968	20
92292	6	70969	25
99205	8	70970	30
99206	10	70971	35
70965	12	70972	42

## Double Anchor Chain Connection, Inox 316



Code	98078	98079
A (mm)	118	164
B (mm)	9,8	13,9
C (mm)	14,5	18,5
D (mm)	8	10,8
E (mm)	7	10,7
For Chain (mm)	6 & 8	10 & 12
Breaking Load (Kg)	2000	6000

## Anchor Chain Connection, Inox 316

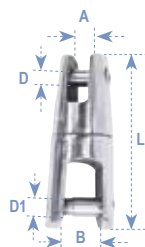

Code	98076	98077	74637
L (mm)	90	115	140
A (mm)	10	14	16
B (mm)	15	18	28
D (mm)	7	10,5	12,5
D1 (mm)	9	10,5	16
For Chain (mm)	6-8	10-12	14-16
Breaking Load (Kg)	2000	4500	7500

## Rocna Anchor

### Available only in Croatia

The Rocna is a true multi-purpose anchor that sets and holds in most seabeds, from soft mud to hard sand, clay, grass, and kelp. The roll-bar ensures that the anchor always arrives at the ideal angle for penetration. A Rocna remains stable and buried, and does not roll out on reversal or veering of load, or if dragged beyond yield, providing enhanced security.



Code	Description
45996	Rocna anchor stainless steel, 4kg
*	Rocna anchor stainless steel, 6kg
*	Rocna anchor stainless steel, 10kg
*	Rocna anchor stainless steel, 15kg
42502	Rocna anchor stainless steel, 20kg
*	Rocna anchor stainless steel, 25kg
*	Rocna anchor stainless steel, 33kg
42606	Rocna anchor stainless steel, 40kg
42479	Rocna anchor stainless steel, 55kg
*	Rocna anchor stainless steel, 70kg
*	Rocna anchor stainless steel, 110kg
*	Rocna anchor stainless steel, 150kg
*	Rocna anchor stainless steel, 200kg
*	Rocna anchor stainless steel, 275kg



Code	Description
42371	Rocna anchor galvanized, 4kg
42372	Rocna anchor galvanized, 6kg
42373	Rocna anchor galvanized, 10kg
42374	Rocna anchor galvanized, 15kg
42375	Rocna anchor galvanized, 20kg
42376	Rocna anchor galvanized, 25kg
42377	Rocna anchor galvanized, 33kg
42378	Rocna anchor galvanized, 40kg
42379	Rocna anchor galvanized, 55kg
42380	Rocna anchor galvanized, 70kg
*	Rocna anchor galvanized, 110kg
*	Rocna anchor galvanized, 150kg
*	Rocna anchor galvanized, 200kg
*	Rocna anchor galvanized, 275kg

## Vulcan Anchor

Vulcan anchor features a unique combination of shank and fluke geometry – including an innovative roll-palm at the rear of the fluke – which self-rights the anchor on the seabed without the use of a roll-bar. This is assisted by the V-bulb which extends fluke ballast downward to gain maximum leverage and efficiency.



Code	Description
*	Vulcan anchor stainless steel, 4kg
*	Vulcan anchor stainless steel, 6kg
*	Vulcan anchor stainless steel, 9kg
*	Vulcan anchor stainless steel, 12kg
*	Vulcan anchor stainless steel, 15kg
*	Vulcan anchor stainless steel, 20kg
*	Vulcan anchor stainless steel, 25kg
*	Vulcan anchor stainless steel, 33kg
*	Vulcan anchor stainless steel, 40kg
*	Vulcan anchor stainless steel, 55kg



Code	Description
*	Vulcan anchor galvanized, 4kg
*	Vulcan anchor galvanized, 6kg
*	Vulcan anchor galvanized, 9kg
42500	Vulcan anchor galvanized, 12kg
*	Vulcan anchor galvanized, 15kg
42481	Vulcan anchor galvanized, 20kg
42477	Vulcan anchor galvanized, 25kg
*	Vulcan anchor galvanized, 33kg
*	Vulcan anchor galvanized, 40kg
*	Vulcan anchor galvanized, 55kg

\*Available upon request



**Bow Roller with Gimbaling End, Inox 304**

Code	90722
Length (mm)	330
Width (mm)	70
For Anchor (Kg)	10



**Universal Bow Roller, Inox 304**

Code	97998	97999
Length (mm)	200	250
Width (mm)	50	
For Anchor (Kg)	7,5	10



**Roller for Anchor Chute 99638, Black**

Code	11907
Length (mm)	42
Roller Diam. (mm)	64



**Anchor Chute, Inox 304**

Code	99638
Length (mm)	165
Width (mm)	50
Diam. (mm)	64



**Bow Roller with Anchor Block, Inox 316**

Code	70612
Length (mm)	240
Width (mm)	100
For chain (mm)	6-8
For anchor (kg)	up to 10



**Hinged Bow Roller, Inox 316**

Code	70634
Length (mm)	328
Height (mm)	236
Thick (mm)	70
For chain (mm)	6-8-10
For anchor (kg)	up to 14



**Roller for Chain or Anchor Line**

Code	95893	95894	73653
Roller Diameter (mm)	54	54	70
Length (mm)	48	62	62

## Swivels & Thimbles

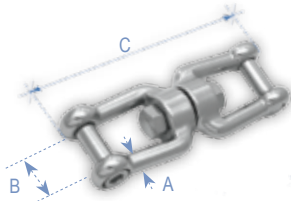

**Jaw & Jaw Swivel with Internal Hexagonal Pin, Inox 316**

\*Surface : E.P, Body: Casting, Pin: Casting

Code	91253	91254	91255	91256
Size (mm)	6	8	10	13
A (mm)	6	8	10	13
B (mm)	13,5	17	21,3	28
C (mm)	64,8	88,6	110,4	156
Working load (kg)	320	500	720	1,200

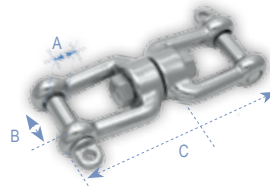

**Jaw & Jaw Swivel, Inox 316**

\*Surface : E.P, Body: Casting, Pin: Forging

Code	91286	91287	91288	91289
Size (mm)	6	8	10	13
A (mm)	6	8	10	13
B (mm)	13	16	22	26
C (mm)	64	88	115	155
Working load (kg)	272,16	498,96	698,54	1197,5

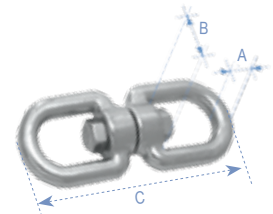

**Eye & Eye Swivel, Inox 316**

\*Surface : E.P, Body: Casting

Code	91232	91233	91234	91235
Size (mm)	5	6	8	10
A (mm)	5	6	8	10
B (mm)	13,6	15,6	20,4	24
C (mm)	56,7	63,6	91,3	118
Working load (kg)	160	320	500	875

**new**



**Double Anchor Swivel, Inox 316, for Chain**

Made of Inox 316, it features high strength and corrosion resistance. It connects the anchor chain with the anchor itself. When the anchor is being lifted, it automatically turns it to the correct side and reeves into the roller. Available options for chain of Ø6-8 mm and Ø10-12 mm.

Code	74372	74373
For Chain ø (mm)	6-8	10-12



## Swivels & Thimbles



Anchoring, Docking & Mooring

### Thimbles

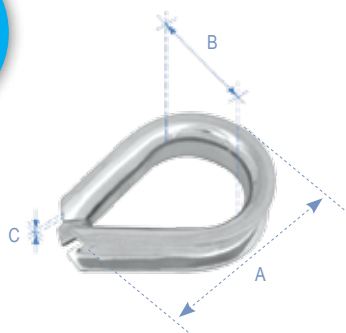

### Galvanized

Code	99378	99379	99380	99381	99382	99383	99384	99385	99386	99387	99388	99389	99390	99391
Size (mm)	2	3	4	5	6	8	10	12	14	16	18	20	22	25
A (mm)	25	28,5	33	36,5	40	51	57,5	66,5	72	82	92	104	115	125
B (mm)	10	12,5	13	16,5	17	22,5	25,3	31	34,5	37,5	40	45	50,5	54
C (mm)	0,8	1	1,2		1,5		2		2,5		3		4	
For wire (mm)	2	3	4	5	6	8	10	12	14	16	18	20	22	25

### Inox 316

Code	90443	91163	91164	91165	91166	91167	91168	91169	91170	91171	91172	91173	91174	91175
Size (mm)	2	3	4	5	6	8	10	12	14	16	18	20	22	25
A(mm)	25	28,5	33	36,5	40	51	58,5	68	74	83	92	104	115	125
B(mm)	10	12,5	13	15,5	17	22,5	26	31	34	37,5	40	45	50,5	54
C(mm)	0,8	1	1,2		1,5		2		2,5		3		4	
For wire (mm)	2	3	4	5	6	8	10	12	14	16	18	20	22	25

Surface E.P.= Electro polished, Body: Forging

### Thimbles



Code	rope Ø (mm)	Material	Code	rope Ø (mm)	Material
16946	3	Nylon PA	44602	12	Nylon PA
44592	4		29372	14	
44594	5		44605	16	
44596	6		44607	18	
24134	7		44609	20	
44598	8		44611	22	
44600	10		44613	24	



## Mooring Ropes & Accessories



Pre-cut

### Shock Absorbing Mooring Line

LALIZAS Polyester Mooring Lines are integrated with industrial rubber filaments which permit high elasticity in absorbing shocks from waves. Shock Lines are highly suitable for docking and anchor lines. Shock-Line Ropes have a loop at one end and all of them are provided in high quality practical packaging.

Code	Diameter (mm)	Length (m)	Breaking Load (Kg)	Elongation (mm)	Boat Length (m)
90347	12	8	2300	200	5-10
90348	15	8	3200	250	10-15
90349	18	8	4000	300	15-20

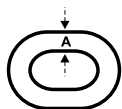
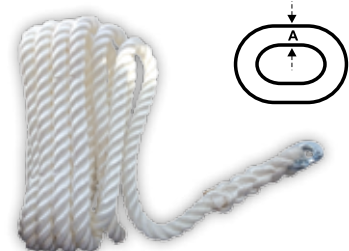
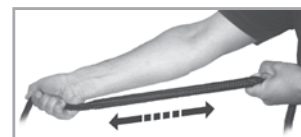

### Rope for Chain Rode Use, 3-Strand, with Connection, Nylon, White

Code	72319	72320	72321	72322	72323	72324
Rope Diameter (mm)		12		14		16
Length (m)	30	60	90	30	60	60
Ring Diameter - A (mm)		6		8		10
Breaking load (kg)		2300		2940		3640





**Mooring Rope, 3-Strand, Double-twisted, Black**



Code	Diameter (mm)	Length (m)	Strength (Kg)	
90854	8	200	640	
90855	10		1.230	
90856	12		1.360	
90857	14		2.010	
90858	16	100	2.430	
90859	18		3.150	
90860	20		3.830	
90861	22		4.610	
90862	24			5.520

**Mooring Rope, 3-Strand, Double-twisted, White**

Code	Diameter (mm)	Length (m)	Strength (Kg)
90844	8	200	570
90845	10		1.110
90846	12		1.220
90847	14		1.810
90848	16		2.190
90849	18		2.830
90850	20	100	3.450
90851	22		4.150
90852	24		4.970
92350	26		5.510
92352	28		6.430
92354	30		7.440
71742	32		8.430
71743	34		9.360
71744	36		10.290
71745	38		10.840
71746	40		11.390

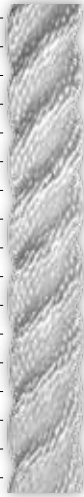

Anchoring, Docking & Mooring

**Mooring Rope, 16-Strand, Double-braided, Polyester, Black**



Code	Diameter (mm)	Length (m)	Breaking Load (kg)
90828	8	200	1600
90829	10	200	1940
90830	12	200	2650
90831	14	200	3465
90832	16	170	4380
90833	18	140	5220
71029	20	100	5500
71030	22	100	5985
71031	24	100	7254

**Mooring Rope, 16-Strand, Double-braided, Polyester, Navy Blue**



Code	Diameter (mm)	Length (m)	Strength (Kg)
71162	12	200	2000
71163	14	200	3000
71164	16	170	4000
71165	18	140	4500
71166	20	100	5000
71167	22	100	7500
71168	26	100	8500

**new**



**Rope Aqua-Multi Polypropylene (floating), Yellow**

The new mooring rope Aqua-Multi is floating and very easy-to-use, essential for safe docking. Made of high-quality polypropylene, it is durable, having an elongation at break of 20-25 %. It is 12-strand and single braided, with high strength and elasticity as well as very good abrasion resistance. Aqua-Multi is available in yellow colour and various dimensions, from 10 to 22 mm.

Code	Diameter (mm)	Breaking Load (kg)
74293	14	3.35Ton / 32.8635KN
74294	18	5.5Ton / 53.955KN
74295	22	7.9Ton / 77.499KN
98286	10	1.65Ton / 16.1865KN

## Mooring Ropes & Accessories



### Mooring Webbing Belt, with Inox Stern Roller

Code	Diameter (mm)	Length (m)	Breaking Load (t)
73643	25	50	2
73644	35	50	4
73645	50	70	4



### Mouse Stopper for Mooring Rope, Set of 2 Pieces

Nuova Rade Mouse Stopper is designed to easily prevent any kind of visit by unwanted guests. It is proven to be very effective, stopping rats from using the docking lines in order to enter your boat.

Code | 198114

- Made of durable PP that is UV and sea water resistant
- Easy to use in mooring ropes from Ø15mm up to Ø35mm without any modification
- Stays stable in rope
- Diameter 312mm
- Weight 0,25kg

## Mooring Springs



### MILLA Mooring Rubber Compensator

Code	44264	44265	44266
For boat (m)	4.5	7	10
For line Ø (mm)	16	20	20
Length (mm)	220	270	330
Width (mm)	40	45	50
Thickness (mm)	33	33	36



### Mooring Spring, Inox 304

Code	70621	70622
Length (mm)	460	460
Diameter (mm)	88	90
Breaking load (Kg)	220	420
For Boats up to aprox. (m)	10	12
Max. Boat weight (ton.)	6	8

Material: EPDM rubber



### Mooring Compensator

Mooring Compensator is an unbreakable, durable and silent shore line damper. Reduces uncomfortable motions when the boat is moored.

Material: EPDM rubber + Inox AISI-316 + PE-HD

Code	For rope diameter (mm)
72698	Ø18mm
72699	Ø22mm







## ELECTRIC TUNNEL THRUSTERS

MAX POWER offers a complete range of 12/24V composite electric tunnel thrusters to suit motor yachts and deep footed sailing yachts from 17'-85'. Designed for maximum performance and durability, each model is easy to fit, highly cost effective, and integrates a variety of unique features.

- Patented composite drive legs
- Zero maintenance
- Case hardened spiro-conical gears
- Line shields
- Purpose-built DC motors
- Electronic control boxes for unrivaled safety features
- Safe, high-power connections
- Purpose-built DC contactors with high specifications

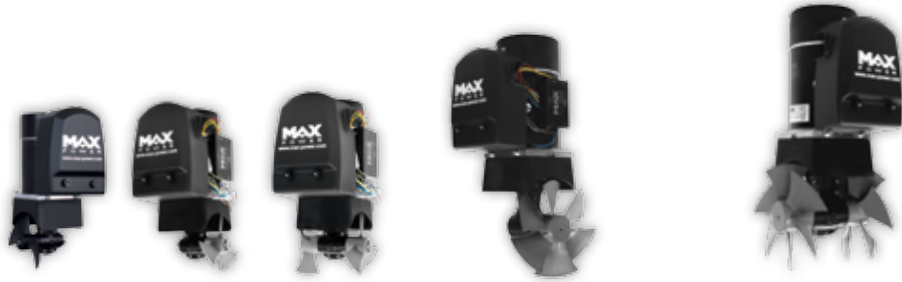

Code	636061	42529	317603	42530	42531	42532	42533
<b>Model</b>	<b>CT 25</b>	<b>CT 35</b>	<b>CT 45</b>	<b>CT 60</b>		<b>CT 80</b>	
<b>Voltage</b>	12V	12 V	12 V	12 V	24 V	12 V	24 V
<b>Max. Thrust at 10,75V (kgf/lbs)</b>	26 / 57,2	30 / 66	40 / 88	63 / 138,6	65 / 143	75 / 165	83 / 182,6
<b>Max. Thrust at 12V (kgf/lbs)</b>	30 / 66	35 / 77	45 / 99	70 / 154	71 / 158,4	80 / 176	89 / 195,8
<b>Propellers</b>	<b>Mono</b>	<b>Mono</b>	<b>Duo</b>	<b>Mono</b>	<b>Mono</b>	<b>Duo</b>	
<b>Drive Leg (material)</b>	Composite	Composite	Composite	Composite	Composite	Composite	
<b>Power (kw/hp)</b>	1.8 / 2.4	2.69 / 3.6	3.23 / 4.3	4.35 / 5.8	4.4 / 5.9	4.79 / 6.4	5.28 / 7.1
<b>Weight (kg)</b>	7	9.6	9.65	14.7	14.8	15	15.1
<b>A (mm)</b>	180	190	190	210		210	
<b>B (mm)</b>	145	140	140	140		140	
<b>C (mm)</b>	225	210	210	275		275	
<b>D (mm)</b>	110	125	125	185		185	
<b>E (mm)</b>	4 to 5	4 to 5	4 to 5	6 to 7		6 to 7	
<b>Boat Type</b>				<b>Boat Length (feet/metre)</b>			
Heavy Displacement, High Windage & Cruising	up to 21' / 6,5 m	17' - 25' / 5,2 - 7,6 m	20' - 28' / 6 - 8,5 m	25' - 32,5' / 7,8 - 10 m		28' - 35' / 6 - 10,6 m	
Medium Displacement, Medium Windage & Fast Cruising	up to 24' / 7,3 m	20' - 28' / 6 - 8,5 m	22,5' - 31' / 6,8 - 9,5 m	26' - 36' / 7,3 - 11 m		30' - 40' / 9 - 12 m	
Light Displacement, Light Windage & Super Fast Cruising	up to 26' / 7,3 m	21' - 31' / 6,4 - 9,5 m	24' - 34' / 7,3 - 10,3 m	27' - 39' / 8,2 - 11,8 m		33' - 46' / 10 - 14m	

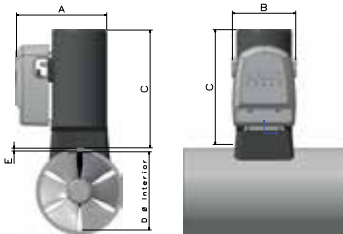

Code	42534	42535	317557	317558	317586	317606	42542	634361
<b>Model</b>	<b>CT 100</b>	<b>CT 125</b>	<b>CT 165</b>	<b>CT 225</b>		<b>CT 300</b>	<b>CT 325</b>	
<b>Voltage</b>	12 V	24 V	24V	24V		24V	24V	
<b>Max. Thrust at 10,75V (kgf/lbs)</b>	96 / 211,2	115 / 253	165 / 363	195 / 429		255 / 561	265 / 583	
<b>Max. Thrust at 12V (kgf/lbs)</b>	105 / 231	122 / 268,4	185 / 407	250 / 550		300 / 660	325 / 715	
<b>Propellers</b>	<b>Duo</b>	<b>Duo</b>	<b>Duo</b>	<b>Duo</b>		<b>Duo</b>	<b>Duo</b>	
<b>Drive Leg (material)</b>	Composite	Composite	Composite	Composite	Bronze	Bronze	Bronze	Aluminium
<b>Power (kw/hp)</b>	7.1 / 9.5	8.58 / 11.5	11.88 / 15.9	14.96 / 20		19.7 / 26.4	19.69 / 26.4	
<b>Weight (kg)</b>	24	24	36	37		58,5	59	
<b>A (mm)</b>	250	250	250	270		250	250	
<b>B (mm)</b>	200	200	200	200		250	250	
<b>C (mm)</b>	356	365	430	405		480	480	
<b>D (mm)</b>	185	185	250	250		300	315	
<b>E (mm)</b>	6 to 7	6 to 7	7 to 8	7 to 8		9 to 10	9 to 10	
<b>Boat Type</b>				<b>Boat Length (feet/metre)</b>				
Heavy Displacement, High Windage & Cruising	32' - 10' / 9,7 - 12 m	35' - 46' / 10,6 - 14 m	40' - 52' / 12 - 15,8 m	45' - 58' / 13,7 - 17,6 m		48' - 63' / 14,6 - 19 m	51' - 69' / 15,5 - 21 m	
Medium Displacement, Medium Windage & Fast Cruising	36' - 48' / 11 - 14,6 m	42' - 55,5' / 12,8 - 17 m	48' - 61' / 14,6 - 18,5 m	53' - 69' / 16 - 21 m		59' - 79' / 18 - 24 m	62' - 87' / 19 - 26,5 m	
Light Displacement, Light Windage & Super Fast Cruising	39' - 51' / 11,8 - 15,5 m	46' - 60' / 14 - 18 m	54' - 65' / 14,5 - 20 m	60' - 75' / 18 - 22,8 m		67' - 93' / 20,4 - 28 m	68' - 100' / 20,7 - 30,5 m	



Anchoring, Docking & Mooring

## IGNITION PROTECTED THRUSTERS

MAX POWER range of ignition protected tunnel thrusters is available for models CT35 to CT125. Certified according to ISO 8846, this range allows the safe use of an electric tunnel thruster in yachts with petrol/gas engine where there may be potentially flammable gases. IP thrusters can also be installed in habitually wet or damp areas such as sail lockers, or in the transom of deep "V" shaped motor yachts.

- Ignition protected to ISO 8846 and water-resistant
- Easy-to-connect thruster
- Patented composite drive leg
- Zero maintenance
- Purpose-built DC motors
- Electronic control boxes for unrivaled safety features
- Safe, high-power connections

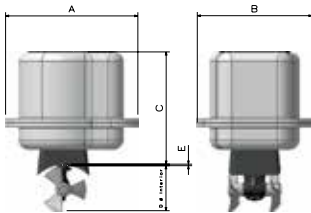

Code	317609	317610	317611	317613	317614	317615	317616
<b>Model</b>	<b>CT 35-IP</b>	<b>CT 45-IP</b>	<b>CT 60-IP</b>	<b>CT 80-IP</b>		<b>CT 100-IP</b>	<b>CT 125-IP</b>
<b>Voltage</b>	12V	12V	12V	12V	24V	12V	24V
<b>Max. Thrust at 10,75V (kgf/lbs)</b>	30 / 66	40 / 88	63 / 138,6	75 / 165	83 / 182,6	96 / 211,2	115 / 253
<b>Max. Thrust at 12V (kgf/lbs)</b>	35 / 77	45 / 99	70 / 154	80 / 176	89 / 195,8	105 / 231	122 / 268,4
<b>Propellers</b>	<b>Mono</b>	<b>Duo</b>	<b>Mono</b>	<b>Duo</b>	<b>Duo</b>	<b>Duo</b>	<b>Duo</b>
<b>Power (kw/hp)</b>	2,69 / 3,6	3,23 / 4,3	4,35 / 5,8	4,79 / 6,4	5,28 / 7,1	7,1 / 9,5	8,58 / 11,5
<b>Weight (kg)</b>	11,6	11,65	17,3	17,6	17,6	27,2	27,2
<b>A (mm)</b>		301		320			390
<b>B (mm)</b>		230		255			305
<b>C (mm)</b>		295		375			490
<b>D (mm)</b>		125		185			185
<b>E (mm)</b>		4 to 5		6 to 7			6 to 7
<b>Boat Type</b>	<b>Boat Length (feet/metre)</b>						
Heavy Displacement, High Windage & Cruising	17' - 25' / 5,2 - 7,6 m	20' - 28' / 6 - 8,5 m	25' - 32,5' / 7,8 - 10 m	28' - 35' / 6 - 10,6 m		32' - 10' / 9,7 - 12 m	35' - 46' / 10,6 - 14 m
Medium Displacement, Medium Windage & Fast Cruising	20' - 28' / 6 - 8,5 m	22,5' - 31' / 6,8 - 9,5 m	26' - 36' / 7,3 - 11 m	30' - 40' / 9 - 12 m		36' - 48' / 11 - 14,6 m	42' - 55,5' / 12,8 - 17 m
Light Displacement, Light Windage & Super Fast Cruising	21' - 31' / 6,4 - 9,5 m	24' - 34' / 7,3 - 10,3 m	27' - 39' / 8,2 - 11,8 m	33' - 46' / 10 - 14m		39' - 51' / 11,8 - 15,5 m	46' - 60' / 14 - 18 m

## HYDRAULIC TUNNEL THRUSTERS

MAX POWER range of hydraulic tunnel thrusters is suitable for medium to heavy displacement and high windage yachts from 40'-85'. Designed for durability and performance, the hydraulic tunnel thrusters are ideal when long runtimes are required. Manufactured with corrosion-resistant components, these models are robust and water-resistant with a variety of unique features.

- Branded hydraulic components
- Long runtimes
- Water-resistant
- Patented composite drive legs
- Zero maintenance
- Electronic control boxes for unrivaled safety features

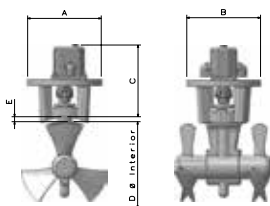

Code	317588	317590	317589	317591	317607	317598	317599
<b>Model</b>	<b>CT 125 HYD</b>			<b>CT 225 HYD</b>	<b>CT 300 HYD</b>	<b>CT 325 HYD</b>	
<b>Max Thrust (kgf/lbs)</b>	140 / 308	120 / 264	90 / 198	220 / 441	300 / 529	275 / 551	325 / 606
<b>Hydraulic power (kw)</b>	13,5	11	7,5	13,5	19,5	14	20
<b>Propellers</b>	<b>Duo</b>	<b>Duo</b>	<b>Duo</b>	<b>Duo</b>	<b>Duo</b>	<b>Duo</b>	<b>Duo</b>
<b>Weight (kg)</b>	12	12	12	19	24	24	24
<b>A (mm)</b>		210		220	240		240
<b>B (mm)</b>		210		220	240		240
<b>C (mm)</b>		215		220	240		240
<b>D (mm)</b>		185		250	300		315
<b>E (mm)</b>		6 to 7		7 to 8	9 to 10		9 to 10
<b>Boat Type</b>	<b>Boat Length (feet/metre)</b>						
Heavy Displacement, High Windage & Cruising	35' - 46' / 10,6 - 14 m			45' - 58' / 13,7 - 17,6 m	48' - 63' / 14,6 - 19 m	51' - 69' / 15,5 - 21 m	
Medium Displacement, Medium Windage & Fast Cruising	42' - 55,5' / 12,8 - 17 m			53' - 69' / 16 - 21 m	59' - 79' / 18 - 24 m	62' - 87' / 19 - 26,5 m	
Light Displacement, Light Windage & Super Fast Cruising	46' - 60' / 14 - 18 m			60' - 75' / 18 - 22,8 m	67' - 93' / 20,4 - 28 m	68' - 100' / 20,7 - 30,5 m	





## HYDRAULIC TUNNEL THRUSTERS

CT 550 HYD & CT 1000 HYD are the flagships of MAX POWER tunnel thrusters for boats up to 55 m. All immersed parts have a specially designed hydrodynamic profile to avoid any turbulence. The most powerful tunnel thrusters in the D400 tunnel category come with 4 blade metallic propellers designed by MAX POWER, to guarantee maximum thrust performance. Counter rotating system offers higher efficiency on thrusting with left side and right side pitch propellers in order to have identical performance in both directions.



Code	636211	636428
Model	CT 550 HYD	CT 1000 HYD
Thruster Power (kw)	min 42 - max 50	min 70 - max 85
Motor Power (cc/kw)	40	80,4
Tunnel Diameter (mm)	400	500
Required Pressure (bar):	min 210 - max 250	
Required Flow (lt/min)	120	200
Propellers	4 Blade, DUO, Counter Rotating	
Weight (kg)	65	145
Light-duty Thrust (Kgf)	630	1200
Heavy-duty Thrust (Kgf)	550	1000
A (mm)	180	251
B (mm)	378	640
C (mm)	249	322
D (mm)	375	488

Boat Type	Boat Length (feet/metre)	
Heavy Displacement, High Windage & Cruising	63 - 105' / 19 - 35 m	100 - 150' / 30 - 45 m
Medium Displacement, Medium Windage & Fast Cruising	71 - 125' / 20 - 37,5 m	105 - 156' / 32 - 47,5 m
Light Displacement, Light Windage & Super Fast Cruising	80 - 140' / 25 - 42 m	115 - 170' / 35 - 52 m

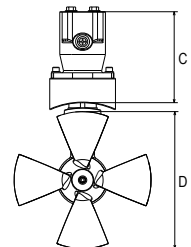
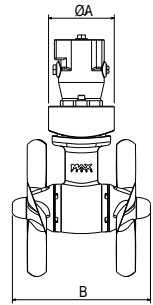

Anchoring, Docking & Mooring

## STERN POD THRUSTER

MAX POWER Stern Pod Thrusters offer an innovative solution to the often difficult tasks of installing a thruster into the stern of modern motor yachts.

- Combining a dry area on the stern with correct immersion depth and sufficient access can be challenging.
- Designed with these constraints in mind, stern pod units can be installed entirely from the outside of the transom, reducing greatly the need for inside access. This allows greater immersion depth to be achieved.
- The stern pod housing is waterproof and ignition protected (ISO 8846) designed to withstand the corrosive damp atmosphere of the bilge.
- Entirely assembled and tested in our factory, stern pod units guarantee long term trouble-free operation with only minimal maintenance care.



Dual propeller

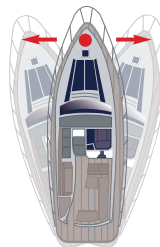

Bow thruster alone

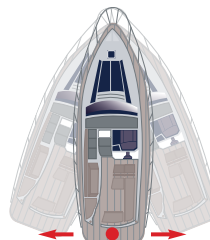

Stern thruster alone

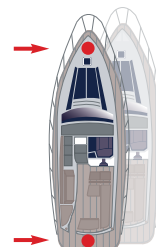

Bow & Stern thrusters

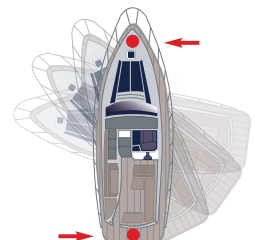

Bow & Stern thrusters

Code	317625	317628	317629	317630	317631	317632	317633
Model	CT45	CT80		CT100	CT125	CT165	CT225
Boat size	6m - 10.5m 20 - 34'	8.5m - 14m 28 - 46'		9.8m - 15.5m 32 - 51'	10.5m - 18m 34 - 59'	12m - 20m 40 - 66'	14m - 22m 46 - 73'
Voltage	12 V	12 V	24 V	12 V	24 V	24 V	24 V
Thrust up to	45 kg	69 kg	75 kg	96 kg	115 kg	160 kg	195 kg
Power	3.2 kW / 4.3 hp	4.8 kW / 6.4 hp	5.3 kW / 7.1 hp	7.1 kW / 9.5 hp	8.6 kW / 11.5 hp	11.9 kW / 15.9 hp	15 kW / 20 hp
Weight	21 kg	31 kg	31 kg	41 kg	41 kg	61 kg	61 kg

## ELECTRIC RETRACTABLE THRUSTERS



Designed for yachts from 9 to 16 metres (30'-52'). This lightweight electric retractable thruster, the first of its kind, has been a major success with shipyards from the very beginning.

- Lightweight composite construction
- Bolted onto flange, not directly laminated into the hull
- No exposed moving parts inside the yacht
- Lowest profile and smallest hull opening on market
- Rapid deployment
- Does not splash inside the yacht
- Intelligent position detection

Code	317821	317822
<b>Model</b>	<b>COMPACT RETRACT™</b>	
<b>Voltage</b>	12 V	24 V
<b>Max. Thrust (kgf/lbs)</b>	70 / 154	85 / 187
<b>Propellers</b>	<b>Duo</b>	<b>Duo</b>
<b>Power (kw/hp)</b>	<b>4.79 / 6.4</b>	<b>5.28 / 7.1</b>
<b>Weight (kg)</b>	40	40
<b>A (mm)</b>	555	250
<b>B (mm)</b>	388	200
<b>C (mm)</b>	385	365
<b>D (mm)</b>	185	185
<b>E (mm)</b>	241	6 to 7
<b>Boat Type</b>	<b>Boat Length (feet/metre)</b>	
Heavy Displacement, High Windage & Cruising	21' - 40' / 9 - 12 m	35' - 46' / 10,6 - 14 m
Medium Displacement, Medium Windage & Fast Cruising	35' - 44' / 10,5 - 13 m	39' - 50' / 11,5 - 15 m
Light Displacement, Light Windage & Super Fast Cruising	36' - 47' / 11 - 14 m	40' - 51' / 12 - 15,5 m

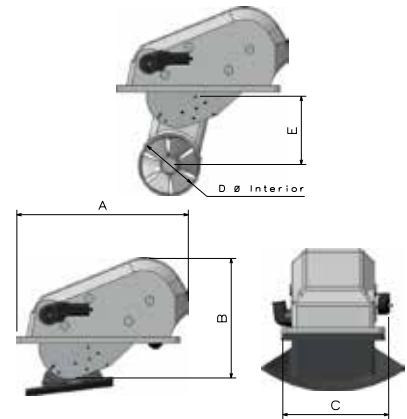

Anchoring, Docking & Mooring

These vertically retracting VIP thrusters use a unique and patented thrust plate design. The largest electric thruster in the MAX POWER range, the VIP 150, is available in both 12V and 24V and is ideally suited to high-performance sailing yachts and super fast motor yachts 40'-60'.

Code	35023	35024	35043
<b>Model</b>	<b>VIP 150 ELECTRIC</b>		<b>VIP 250 ELECTRIC</b>
<b>Voltage</b>	12 V	24 V	24 V
<b>Max. Thrust (kgf/lbs)</b>	96 / 212	115 / 254	145 / 319
<b>Propellers</b>	<b>Duo</b>	<b>Duo</b>	<b>Duo</b>
<b>Power (kw/hp)</b>	<b>7,1 / 9,5</b>	<b>8,56 / 11,5</b>	<b>9,5 / 12,74</b>
<b>Weight (kg)</b>	40	40	54
<b>A (mm)</b>	330		360
<b>B (mm)</b>	290		360
<b>C (mm)</b>	710		765
<b>D (mm)</b>	185		250
<b>E (mm)</b>	970		1075
<b>E (mm)</b>	240		295
<b>Boat Type</b>	<b>Boat Length (feet/metre)</b>		
Heavy Displacement, High Windage & Cruising	21' - 40' / 9 - 12 m	35' - 45' / 10,5 - 13,5 m	
Medium Displacement, Medium Windage & Fast Cruising	35' - 44' / 10,5 - 13 m	39' - 50' / 11,5 - 15 m	
Light Displacement, Light Windage & Super Fast Cruising	36' - 47' / 11 - 14 m	40' - 51' / 12 - 15,5 m	

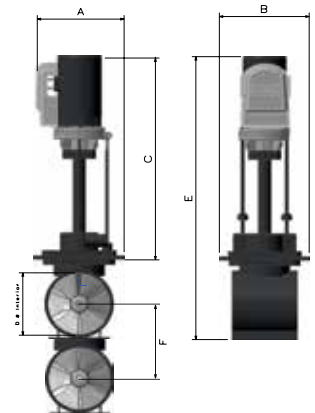

## HYDRAULIC RETRACTABLE THRUSTERS

When performance is paramount, hydraulic retractable thrusters provide a perfect solution. Lightweight, powerful and allowing near perfect weight distribution, designers and prestigious yards have consistently trusted MAX POWER thrusters over the years. MAX POWER offers two product ranges in this family: the vertically retractable VIP HYD range and the top end Retractable™ foldable series.

Code	317702	317703	317705
<b>Model</b>	<b>VIP 150 HYD</b>		<b>VIP 250 HYD</b>
<b>Voltage</b>	12V control	24 V control	24 V control
<b>Max. Thrust (kgf/lbs)</b>	120 / 264		200 / 441
<b>Propellers</b>	<b>Duo</b>		<b>Duo</b>
<b>Hydraulic Power (kw)</b>	10		13,5
<b>Weight (kg)</b>	28		37
<b>A (mm)</b>	290		360
<b>B (mm)</b>	290		360
<b>C (mm)</b>	580		620
<b>D (mm)</b>	185		250
<b>E (mm)</b>	810		950
<b>F (mm)</b>	240		295
<b>Boat Type</b>	<b>Boat Length (feet/metre)</b>		
Heavy Displacement, High Windage & Cruising	40' - 50' / 12 - 15 m		50' - 65' / 15 - 20 m
Medium Displacement, Medium Windage & Fast Cruising	45' - 55' / 14 - 17 m		54' - 75' / 16,5 - 23 m
Light Displacement, Light Windage & Super Fast Cruising	48' - 60' / 14,5 - 18 m		57' - 80' / 17 - 24 m

- Retract to leave smooth hull lines
- When deployed, ideal immersion depth is achieved
- Water-resistant
- Allow ideal weight distribution
- Ideal for high performance yachts
- Unique patented thrust plate design (VIP)
- Unique patented folding movement (Retract™)
- Case hardened spiro-conical gears
- Lightweight design

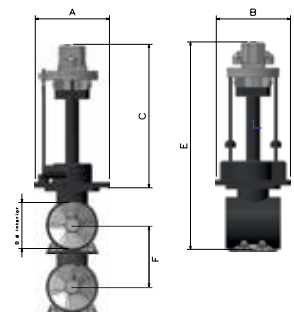



## HYDRAULIC RETRACTABLE THRUSTERS

### R 200/6 - R 200/8

Benefiting from a control system redesign, R 200 is the smallest model in the MAX POWER Retractable™ range. Designed for top end production boats, this hydraulic retractable thruster has long been installed in prestigious yachts ranging from 45' - 68'.



Code	317803	317804	317810	317811
Model	R 200/6	R 200/8	R 300/15	R 300/21
Power Ratings (hp)	10 / 17		20 / 34	
Thrust	10 kgf per kw		11 kgf per kw	
Max. Hydraulic power (kw)	13		25	
Hydraulic Power	20 lpm / 200-230 bar	30 lpm / 220-250 bar	28-35 lpm / 220-260 bar	45-55 lpm / 230-270 bar
Power Pack Options	PTO & 24V		PTO & 24V	
Hydraulic Motor	Piston		Piston	
Opening/closing Mechanism	Electric & Manual		Hydraulic & Gas Spring	
Propellers	Duo, 2 blades		Duo, 3 blades	
Weight (kg)	35		73	
A (mm)	500		665	
B (mm)	355		500	
C (mm)	320		450	
D (mm)	200		300	
E (mm)	255		360	

Boat Type	Boat Length (feet/metre)	
Heavy Displacement, High Windage & Cruising	45' - 56' / 14 - 17 m	60' - 85' / 18 - 26 m
Medium Displacement, Medium Windage & Fast Cruising	49' - 61' / 15 - 18,5 m	77' - 95' / 23,5 - 29 m
Light Displacement, Light Windage & Super Fast Cruising	53' - 69' / 16 - 21 m	75' - 104' / 23 - 32 m

### R450/34 - R450/40 - R450/50

Light & robust this thruster unit has been designed specifically for performance yachts, both sail & motor from 80'-136'. With positive locking and a unique gas spring lifting system, the R450 can withstand the pounding that offshore performance boats endure.



Code	317813	317814	317912	317819
Model	R 450/34	R 450/40	R 450/50	R 600
Power Ratings (hp)	50 / 65 / 80			75 / 110
Thrust	11 kgf per kw			11 kgf per kw
Max. Hydraulic power (kw)	60			85
Hydraulic Power	Upon Request			Upon Request
Power Pack Options	PTO			PTO
Hydraulic Motor	Piston			Piston
Opening/closing Mechanism	Hydraulic & Gas Spring			Twin Hydraulic
Propellers	Duo, 5 blades			Mono, 4 blades
Weight (kg)	165			320
A (mm)	940			1210
B (mm)	748			967
C (mm)	460			985
D (mm)	450			600
E (mm)	540			772

Boat Type	Boat Length (feet/metre)	
Heavy Displacement, High Windage & Cruising	80' - 110' / 24 - 33,5 m	100' - 140' / 30,5 - 43 m
Medium Displacement, Medium Windage & Fast Cruising	90' - 125' / 27,5 - 38 m	110' - 150' / 33,5 - 46 m
Light Displacement, Light Windage & Super Fast Cruising	100' - 138' / 30,5 - 42 m	125' - 165' / 38 - 50 m

### R 300/15 - R 300/21

R 300 benefits from evolutions already pioneered on the R 450. Both light & powerful this unit has been consistently trusted by designers around the world for many years and is ideal for yachts from 60'-104'.

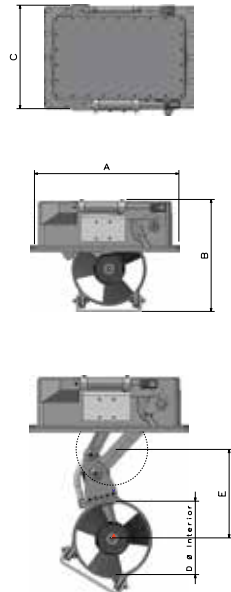

### R600

An ingenious design makes this thruster the lightest and arguably the safest 100HP retractable thruster available. With a locking system inspired by aircraft cargo doors, and thrust transfer pads to transmit load to the hull, performance is first and foremost with this unit ideal for yachts from 100'-167'.

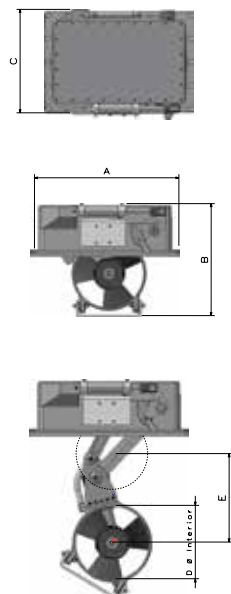

Anchoring, Docking & Mooring



## ANL FUSE & ANL FUSE HOLDER



Thruster model	CT25	CT35 / CT45	CT60 / CT80 C. Retract	CT60 / CT80 / C. Retract	CT100 / VIP150	CT125 / VIP150	CT165	CT225
Voltage	12 V	12 V	12 V	24 V	12 V	24 V	24 V	24 V
Amp	150 A	175 A	225 A	175 A	400 A	225 A	325 A	400 A
Fuse	636342	636343	636344	636343	636346	636344	636345	636346
Fuse holder	636347							

## CONTROL PANELS & REMOTE CONTROL

All control panels are specially designed for use with the complete range of MAX POWER tunnel and retractable thrusters. Fitted using a simple hole saw cut-out, panels are easy to install and benefit from a simple and easily replaceable weatherproof clip-on cover. Each panel is complete with both male and female connectors using a reusable connection system.

**Waterproof Rating IP 67**

- Available in black or grey colour
- Water-resistant
- Easy to fit
- Replaceable clip-on cover
- Safety features



Model	Touch panel		Joystick Simple		Joystick Double	
Code	318200	318201	318202	318203	318204	318205
Color	Black	Grey	Black	Grey	Black	Grey
Compatible with	All tunnel thrusters		All tunnel thrusters		All tunnel thrusters	
Dimension	65 x 65 mm		65 x 65 mm		65 x 117 mm	



Model	Touch Panel Double	Joystick		Joystick Simple	Control Panel Boat
Code	318233	318206	318224	318226	318234
Color	Black	Black	Grey	Black	Black
Compatible with	All retractable thrusters, in combination with 318204 - 318205 - 318234	Compact Retract all VIP & R200		R300 & R450	Combined use of a bow and stern thruster
Dimension	65 x 117 mm	65 x 117 mm		65 x 117 mm	65 x 117 mm

## Proportional Electronic System Kit for Tunnel Thrusters



**Compatible with:**  
Electric tunnel thrusters

**Included:**  
1 Electronic Controller, CT Thrusters, 24V  
2 High Power Unit, CT Thrusters, 24V, 900A  
3 Joystick, CT Thrusters, 5V

Code | 72632



3

2

1





## Radio Remote Control

Code	312973	312974	312971	312972	312969	312970
Frequency	868 MHz	915 MHz	868 MHz	915 MHz	868 MHz	915 MHz
Description	Transmitter + Receiver (EU)	Transmitter + Receiver (USA)	Additional receiver (EU)	Additional receiver (USA)	Spare transmitter (EU)	Spare transmitter (USA)

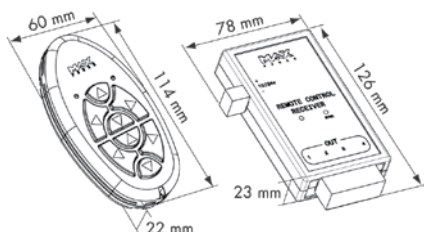

\*868 MHz is the authorised frequency for Europe and Australia. 915 MHz is the authorised frequency for Canada and the USA. Retail sales and use of non-authorised frequency transmitters and receivers is prohibited. For all other countries, please consult the local regulation in force.



Anchoring, Docking & Mooring

## Fenders



### R SERIES - Buoys

R Series Buoys are heavy-duty buoys in which the rib-reinforced rock solid rope hold is made in such a way to provide extra strength and durability. This is a versatile commercial fishing buoy for the most adverse conditions. Can be used as a marking gear for ocean, sea, river, lake, beaches, cable installation and swimming. R Series Buoys have become widely popular among commercial fishermen in longline fishing for their durability and also among recreational boats. These buoys are one-piece made (no parts are attached together to form the finalised buoy) with consistent wall thickness and UV resistance.

**Inflation pressure:**  
2.1lbs/0.15bar at 68°F/20°C

**Material:** Plastisol PVC

**Production process:** Single rotational moulding process



Model	Code	Code	Dimensions A x B (mm)	Eye Diameter D (mm)	Volume per products (lt)	Buoyancy (kg)	Weight (kg)	OCEAN Cover	Boat Size (ft/m)
R0	71993	72001	220 x 300	15	5,9	6	0,7	-	up to 16/up to 5
R1	71994	72002	280 x 380	24	12,9	14	1,2	4934	10-20/3-6
R2	71995	72003	380 x 500	28	30,9	32	2	49358	20-35/6-11
R3	71996	72004	440 x 580	28	49	54	3	49359	25-40/8-12
R4	71997	72005	520 x 680	28	82,6	90	4	49360	35-45/11-14
R5	71998	72006	680 x 900	30	179,1	205	6,2	49361	40-55/12-17
R6	71999	72007	880 x 1120	38	376	400	8	49362	55-70/17-21

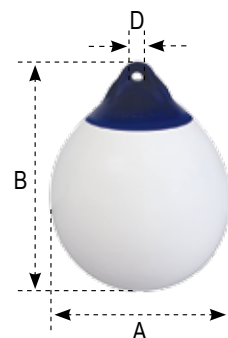

Available in yellow colour upon request and sufficient quantities.

## H SERIES – Heavy-Duty Fenders

The classic series of OCEAN Boat Fenders with superior quality! Made of Plastisol PVC with rotational moulding process, they are one-piece made (no parts are attached together to form the finalised fender) with consistent wall thickness. H Series Fenders are heavy-duty ones in which the rib-reinforced rock solid rope holds in the two sides of the fender are made in such a way to provide extra strength and durability. A versatile fender for the most adverse conditions. Suitable for any use and boats of any kind from 10-50 ft.

**Inflation pressure:** 2.1lbs/0,15bar at 68°F/20°C  
**Material:** Plastisol PVC  
**Production process:** Single rotational moulding process

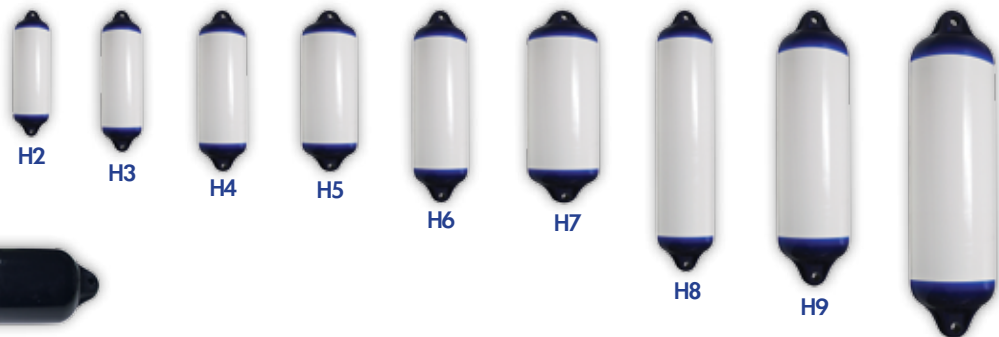

Model	Code	Code	Dimensions A x B (mm)	Eye-Diameter D (mm)	Volume per products (lt)	Weight (kg)	OCEAN Cover	Boat Size (ft/m)
H2	71984	72453	140 x 500	13	6,3	0,70	-	10-20/3-6
H3	71985	72148	160 x 560	18	9,1	1,20	49932	15-30/5-9
H4	71986	72454	190 x 640	18	14,5	1,75	72631	20-35/6-11
H5	71987	72137	220 x 640	22	18,6	2	49351	25-40/8-12
H6	71988	72138	220 x 760	22	23,2	2,30	49352	30-45/9-14
H7	71989	72455	280 x 760	24	35,1	3	49354	35-50/11-15
H8	71990	72139	220 x 1040	22	33,8	3	49353	40-55/12-17
H9	71991	72456	280 x 1090	24	55,4	4	49355	45-60/14-18
H10	71992	-	380 x 1470	45	127	7,2	-	over 65/over 20



Anchoring, Docking & Mooring

**Combine with**  
 OCEAN Fender Covers  
 page 99



## U SERIES – Utility Fenders

A utility boat fender suitable for every yacht and every use. U Series combines simplicity and elegance offering the ultimate touch of style with high gloss finish. Options are available in white, royal blue or black colour and in six different sizes. These utility fenders are one-piece made (no parts are attached together to form the finalised fender), resulting in consistent wall thickness of the fender. Made of Plastisol PVC material with rotational moulding process, they are the highest quality utility fenders in the market. The simple valve of the boat fender offers convenient inflation and maximum protection at the same time.

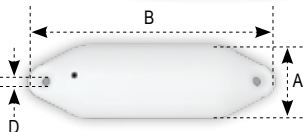
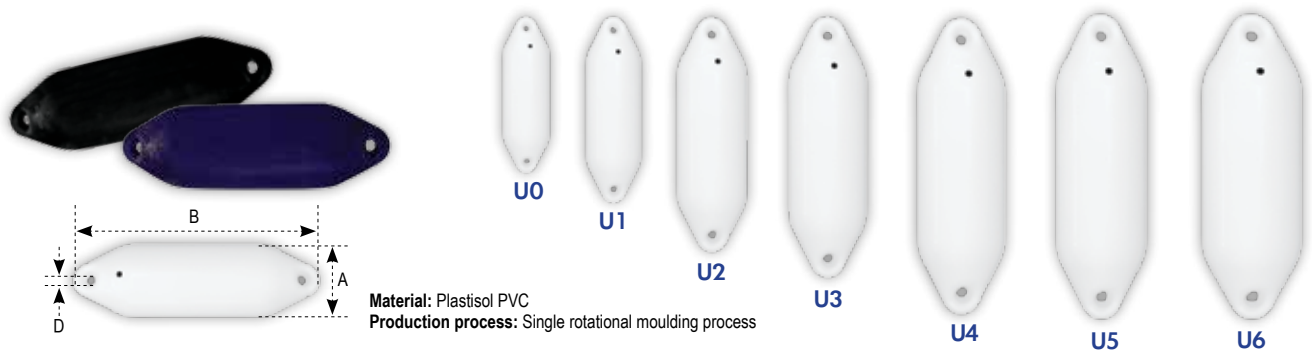

**Material:** Plastisol PVC  
**Production process:** Single rotational moulding process

Model	Code	Code	Code	Dimensions A x B (mm)	Eye-Diameter D (mm)	Volume per products (lt)	Weight (kg)	OCEAN Cover	Boat Size (ft/m)
U0	72260	72358	72359	100 x 330	13	1,8	0,40	-	up to 10/ up to 3
U1	72261	72360	72361	120 x 400	16	3,6	0,52	-	10-20/3-6
U2	72262	72362	72363	140 x 500	16	6,3	0,80	-	15-25/5-8
U3	72263	72364	72365	160 x 560	19	9,1	1	49932	15-30/5-9
U4	72264	72366	72367	190 x 640	19	14,5	1,55	72631	20-35/6-11
U5	72265	72368	72369	220 x 640	22	18,6	2	49351	25-40/8-12
U6	72557	72558	72559	220 x 760	22	21,1	3	49352	30-45/9-14





### CH SERIES – Centre Hole Fenders

CH Series of Centre Hole Fenders distinguishes for its multiple use since these fenders are designed for horizontal and vertical application to any small to medium sized boat. The CH Series, introduced by OCEAN, is the point when simplicity and elegance become one, with the high gloss finish giving you the ultimate touch of style. In addition, these fenders are one-piece made (no parts are attached together to form the finalised fender), resulting in consistent wall thickness. As all OCEAN fenders, these are made of Plastisol PVC material, through rotational moulding process. The simple valve of the fender offers convenient inflation and maximum protection at the same time. CH Boat Fenders are accompanied with white rope in order to make your life easier!

Model	Code	Dimensions (mm)	Hole Diameter D (mm)	Rope Length (mm)	Volume per products (ft)	Weight (Kg)	OCEAN Cover	Boat Size (ft/m)
CH0	72266	100 x 300	16	1000	2,9	0,5	-	up to 15/ up to 5
CH1	72267	150 x 430	16	1200	9	1	49932	15-25/5-8
CH2	72268	200 x 550	16	1400	23,4	2	49351	15-35/5-11

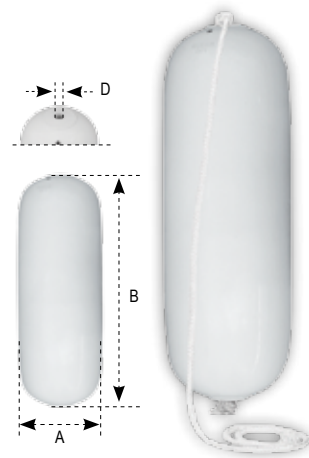

**Combine with**  
OCEAN Fender Covers  
page 99

**Material:** Plastisol PVC  
**Production process:** Single rotational moulding process



### SERIES RT Rope - Through Fenders

RT Series of Rope-Through Fenders distinguishes for its multiple use since these fenders are designed for horizontal and vertical application for any yacht. This series is the point where performance and strength become one, with the reinforced vertical ribs giving you the extra protection you need. In addition, these fenders are one-piece made (through rotational moulding process), resulting in consistent wall thickness thought the fender. As all of the OCEAN fenders, they are made of Plastisol PVC material. The simple valve of the fender offers convenient inflation and maximum protection at the same time.

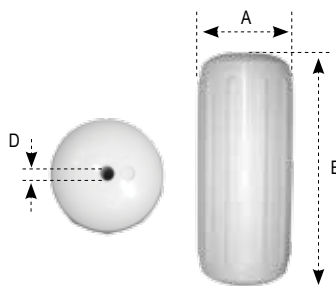

**Inflation pressure:** 2.1lbs/0,15bar at 68° F/20°C  
**Material:** Plastisol PVC  
**Production process:** Single rotational moulding process

Model	Code	Dimensions A x B (mm)	Tube-Diameter D (mm)	Volume per products (ft)	Weight (kg)	OCEAN Cover	Boat Size (ft/m)
RT1	72107	160 x 395	16	7,7	0,5	49932	15-25/5-8
RT2	72108	215 x 520	16	18,3	1	49351	25-35/8-11
RT3	72109	265 x 685	16	36,6	2	-	35-50/11-15

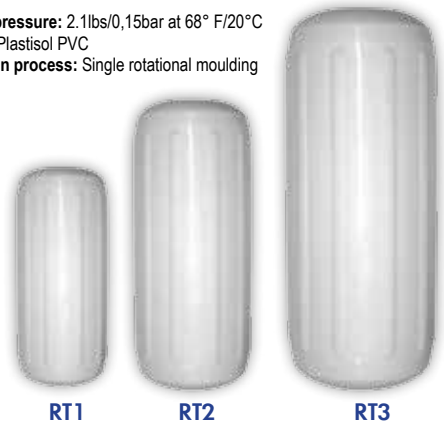

### Bow Fenders

Bow Fenders by OCEAN, as the name suggests, have been designed in order to protect the bow of your boat. This new boat fender series by OCEAN is the best solution in terms of price and convenience. These fenders are produced in two different sizes in order to fit all different boats, as well as in blue and white colour with UV resistant material in order to avoid fading under the sun. They have three eyes for easy and safe installation, and for making sure that they will stay in place. The simple valve of this boat fender offers convenient inflation and maximum protection at the same time.

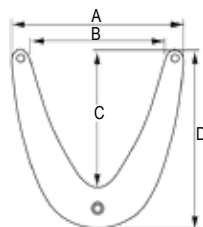

Size	Code	Code	A (mm)	B (mm)	C (mm)	D (mm)
Medium	72908	72909	360	280	260	340
Large	72910	72911	520	440	390	490



### Optimist Buoyancy Tubes with Valve, Grey

Code	Material	Maximum Air Pressure	Dimensions
57353	PVC	0,5PSI	41x100cm
57354	Nylon with TPU	3,6PSI	

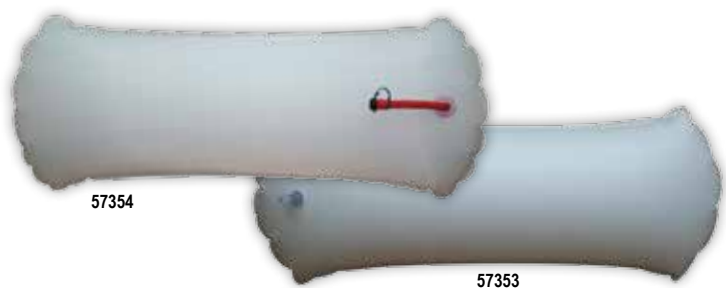

Anchoring, Docking & Mooring

## EASYSTORE PLUS Inflatable Fenders

EASYSTORE PLUS Inflatable Mega Yacht Fender is made of reinforced, abrasion resistant PVC material. Lightweight, simple to use and when deflated can be stowed in small lockers. EASYSTORE PLUS can be quickly inflated by using any standard or electric pump and easily mounted using the rope supplied. Available in various sizes and in light grey colour.

- Thickness: 0,9mm
- Material: PVC Body
- D-ring
- Rope: Ø 7mm
- Recommended inflation pressure: 2,4psi

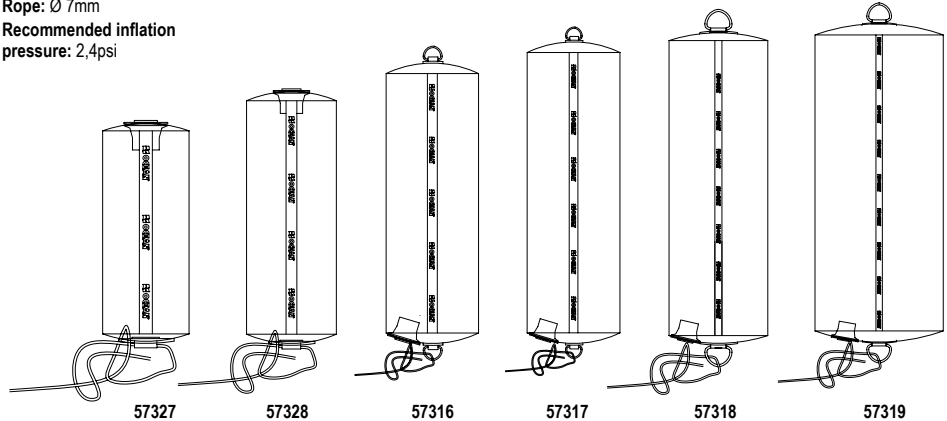

Code	Diameter (mm)	Length (mm)	D-ring on top	D-ring on bottom	Buoyancy (kg)	Rope (m)	OCEAN Cover	Boat Size (ft/m)
57327	200	500	-	stripe	15	3	72631	20-30/6-9
57328	250	700	-	stripe	35	3	49354	30-40/9-12
57316	280	850	1	1	52	3	49355	40-50/12-15
57317	320	1040	1	1	84	3	72625	50-70/15-21
57318	420	1320	1	1	184	5	72626	40-140/21-43
57319	600	1500	1	1	427	5	72627	140-210/43-64

Anchoring, Docking & Mooring



## MAGNUS Inflatable Fenders

MAGNUS Inflatable Mega Yacht Fender is made of a copolymer blend of PVC/EVA/UV material. There are options with 1 and 3 D-rings attached on each side of the fender, as well as wrap around straps for better durability and strength. Lightweight in regard to its size, simple to use and when deflated can be stowed in small lockers. It can be quickly inflated by using any standard or electric pump and easily mounted using the rope supplied. Trusted by superyacht captains around the globe, it has never let them down when needed. Covers are optional but they are recommended if you wish to add on some extra style to the fender. MAGNUS Inflatable Mega Yacht Fender is available in various sizes and in black colour.



- Thickness: 1.2 mm
- Material: PVC Body
- D-ring
- Wrap around tape
- Recommended inflation pressure: 2,4psi

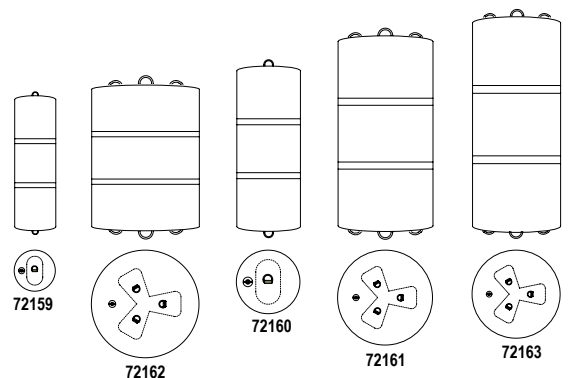

Code	Diameter (mm)	Length (mm)	D-ring on top	Buoyancy (kg)	D-ring on bottom	OCEAN Cover	Boat Size (ft/m)
72159	420	1450	1	184	1	72626	130-190/40-58
72162	1100	1700	3	1420	3	72629	130-190/40-58
72160	650	1750	1	1290	1	72627	140-210/43-64
72161	970	2100	3	534	3	72628	over 200/over 60
72163	900	2350	3	1345	3	72630	over 210/over 67



**SOLOVELA**

SOLOVELA Solid Fender serves as a multipurpose boat fender and it is the best in its class by offering optimum shock absorption and lifetime performance. It is manufactured with Flexible Integral PU Skin Foam technology, so it is a boat fender that cannot deflate. In addition it has remarkable durability having been tested under the pressure of 12 tons per dm<sup>2</sup>. The fender's wide surface area ensures a better distribution of the load and reduction of the specific pressure per cm<sup>2</sup>. SOLOVELA Solid Fender stands out for its innovative shape and exclusive design, specifically for sailboats, which combines ergonomics and protection. By offering very easy fitting on the sail boat's lifeline and requiring no stowage while sailing, it's always in place and ready to use. It remains steady on the lifeline even with strong wind, without having to worry about being dropped into the sea. You can also use SOLOVELA as a boarding step or as a backrest for the captain during sailing. SOLOVELA Solid Fender is supplied with a navy blue or sand colour, UV-resistant zip-on cover and a 3 m white polyester line. The fender has one through hole with nylon fiber reinforced bushes for easy and safe installation with the supplied line.

L (mm)	H (mm)	W (mm)	∇ (ft)	⊕ (kg)
380	600	190	30-70	4,2



- 473215
- 197742



**Tested under 12 tons per dm<sup>2</sup>.**  
Can also be used as a step and as a backrest.



Anchoring, Docking & Mooring



**Combine with**  
OCEAN Fender Covers  
page 99

**Cover for SOLOVELA**

- 197782
- 197783

**TYPE A Clip-on Fenders**

TYPE A Clip-on Boat Fender is the first and unique solid fender, which clips on the guardrail, and is manufactured with Flexible Integral PU Skin Foam technology. It is a boat fender that cannot deflate. It offers the best shock absorption and lifetime performance among other boat fenders, providing exceptional protection. It has impressive durability, as this fender cannot deflate no matter the pressure. It is always in place and ready to use in seconds, and it remains steady even with strong wind. There is no need for fender baskets or other inconvenient stowage and they don't get in the way on the side decks. It can be used for the protection of the boat both horizontally and vertically. The TYPE A Clip-on Solid Fender has one through hole with nylon fiber reinforced bushes for easy and safe installation.

Model	Code	Code
A1	○ 197747	● 197748
A2	○ 197749	● 197750
A3	○ 197751	● 197752
A4	○ 197753	● 197754

Model	∅ (mm)	M (mm)	⊕ (kg)	∇ (ft)	∅ GUARDRAILS (mm)
A1	160	380	1,5	20	20-26
A2	200	460	2,5	33	20-28
A3	230	530	3,8	43	25-30
A4	250	600	4,8	>43	25-30



**MATCH 60**

MATCH 60 is the first and unique universal stern solid fender, which is manufactured with Flexible Integral PU Skin Foam technology. It is a boat fender that cannot deflate. It has the best shock absorption and lifetime performance in class, providing exceptional boat protection and durability. In addition, MATCH 60 Solid Fenders' innovative shape and exclusive design combine ergonomics and protection for the stern, which is one of the most vulnerable parts of the boat. Always in place, it fits all shapes of stern. With one through hole with nylon fiber reinforced bushes for easy and safe installation.

M (mm)	Y (mm)	Π (mm)	⊕ (kg)
600	320	250	4,2

- 421084
- 421110

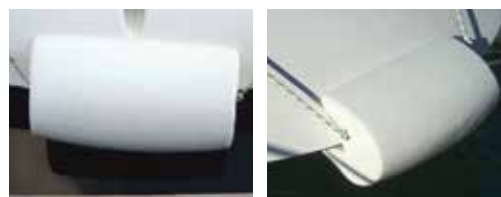

## MATCH 80

MATCH 80 is the first and unique stern fender for 90° stern shape, which is manufactured with Flexible Integral PU Skin Foam technology. It is a boat fender that cannot be deflated. It has the best shock absorption and lifetime performance in class, providing exceptional boat protection and durability. In addition MATCH 80 Solid Fenders' innovative shape and exclusive design, combines ergonomoy and protection for the stern, which is one of the most vulnerable parts of the boat. Designed to stay fixed in place, it is ideal for stern berthing fitting all stern shapes from 75° to 90°. MATCH 80 Stern Fender has one through hole with nylon fiber reinforced bushes for easy and safe installation.



Anchoring, Docking & Mooring



M (mm)	Y (mm)	Π (mm)	⊗ (kg)
660	280	240	4,2

○ 197744 ● 197743



## PVM1

PVM1 is the first and unique universal bow solid fender, which is manufactured with Flexible Integral PU Skin Foam technology. It is a fender that cannot deflate. It has the best shock absorption and lifetime performance in class, providing exceptional boat protection and durability. It is a multipurpose fender, ideal for bow berthing, for protecting the swimming platform and for dock fending. In addition it protects the bow from anchor swinging. Its innovative shape and exclusive design, combines ergonomoy and protection for the stern and bow, which are the two most vulnerable parts of the boat. PVM1 Bow Solid Fender is designed to stay fixed in place and has two through holes with nylon fiber reinforced bushes for easy and safe installation.



L (mm)	H (mm)	W (mm)	⊗ (kg)
600	250	170	3,2

○ 472461 ● 472462



## PVM2

PVM2 Solid Fender is ideal for protecting the corners of your boat's swimming platform, having been made with thickness up to 15cm. It is manufactured with Flexible Integral PU Skin Foam technology. It is a fender that cannot deflate. It has the best shock absorption and lifetime performance in class, providing exceptional boat protection and durability. With two through holes with nylon fiber reinforced bushes for easy and safe installation. Additionally, it can be used in combination with PVM1 Solid Fender to ensure the best protection for your swimming platform.



L (mm)	H (mm)	W (mm)	⊗ (kg)
430	240	250	2,5

○ 472463 ● 472464

- Ideal for swim platforms applications
- It is designed for corner protection





**BLADE Cruiser/Racer**

BLADE Cruiser/Racer Fender is the first and unique bow solid fender for 90° bow shape that fits in all bow shapes up to 7cm wide and it is manufactured with Flexible Integral PU Skin Foam technology. It has the best shock absorption and lifetime performance in class, providing exceptional bow protection and durability, as it cannot deflate. Designed to stay fixed in place. One through hole with nylon fiber reinforced bushes for easy and safe installation.



L (mm)	H (mm)	W (mm)	(kg)	MAX BOW SHAPE WIDTH (mm)
1040	160	120	2,7	70

○ 197745 | ● 197746



The first and unique bow fender for 90° stern shape.



Anchoring, Docking & Mooring

**Fender Covers & Accessories**

**Fender Covers**

All OCEAN Fender & Buoy Covers are manufactured in-house using knitting machines of the latest technology. Our covers are handcrafted with 100% polar fleece material for high durability and performance. Resistant to sunlight and water, they are also tested to ensure friction resistibility. Developed for the most demanding situations at sea, during mooring, OCEAN Fender & Buoy Covers provide the ultimate protection for your boat, extending also the fender life at the same time.

- Perfect fitting
- Quick and easy installation
- Washable

Code	Maximum Fender Dimensions (mm)		Thickness	Pieces per package	Fits OCEAN fenders
	Max Diameter (D)	Max Height (H)			
49932	160	560	Single	2	H3/U3/RT1/CH1
72631	190	640	Single	2	H4/U4/ Easystore 57327
49351	220	640	Single	2	H5/U5/RT2/CH2
49352	220	760	Single	2	H6/U6
49354	280	760	Single	2	H7/ Easystore 57328
49353	220	1040	Single	2	H8
49355	280	1090	Single	2	H9/ Easystore 57316

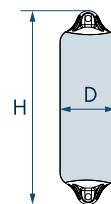

Code	Maximum Fender Dimensions (mm)		Thickness	Pieces per package	Fits OCEAN fenders
	Max Diameter (D)	Max Height (H)			
49934	280	380	Single	2	R1
49358	380	500	Single	2	R2
49359	440	580	Single	2	R3
49360	520	680	Single	2	R4
49361	680	900	Single	2	R5
49362	880	1120	Double	1	R6

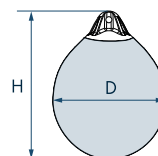

Code	Maximum Fender Dimensions (mm)		Thickness	Pieces per package	Fits OCEAN fenders
	Max Diameter (D)	Max Height (H)			
72625	320	1040	Double	1	Easystore 57317
72626	420	1320	Double	1	Easystore 57318/ Magnus 72159
72627	650	1600	Double	1	Easystore 57319/ Magnus 72160
72628	970	1910	Double	1	Magnus 72161
72629	1100	1350	Double	1	Magnus 72162
72630	900	2100	Double	1	Magnus 72163

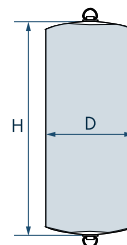

Code	Colour	Thickness	Pieces per package	Fits OCEAN fenders
197782	Blue	Single	1	Solovela 473215
197783	Beige	Single	1	Solovela 197742

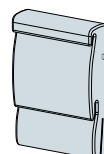



### Fender Adjuster, 4 pcs

OCEAN Fender Adjuster is ideal and easy to use when you wish for quick placement of boat fenders anywhere at any time.

- 4 unit- pack
- **Material:** PE-HD High density polyethylene

Code | 72702

### Hook for Fenders

Designed to make the procedure of attaching and adjusting boat fenders easier, by placing them into the boat rail. Made of polyamide and available in two colours & two dimensions.



Code	Description	Colour	Length (mm)	Width (mm)	Ø Eye (mm)
43634	For installation on a Ø 6 mm cable	White	86	25	7
43635		Black			
43640	For installation on rail Ø from 20 to 22 mm.	White	85	38	21
43641		Black			

### Inflation Adapter for Fender Valve

Designed for the inflation of OCEAN H-Series and R-Series OCEAN Fenders. It is compatible with all Nuova Rade pumps and inflators. Made of PA and available in a Ø 14 mm dimension.

Code | 56860



Pre-cut

### Fender Line, Double-braided, with Loop, Polyester, Navy blue

Code	Diam. (mm)	Length (m)	Breaking Load (kg)	Boat length (m)
90812	8	2	1600	< 6
90813	10	2	1940	6 - 8
90814	12	3	2650	> 8



### Modular Fender Basket, Inox



Code	Diameter (mm)	Height (mm)	Fenders	
			Lalizas Hercules	Polyform
98630	180	420	50583, 50593, 50584, 50594, 50633, 50634	71254/F1
98629	220	440	50585, 50595, 50586, 50596, 50635, 50660, 50636	71255/F02
98631	250	450	50661, 50662, 50663	71256/F2, 71257/F3, 71258/F4
98632	340	590	50664, 50665	71259/F5, 71260/F6

### Connector Parallel for Fender Baskets, 2 pcs



Code | 90163



### Connector & Rail Support for Fender Baskets, Set



Code | 90154





**Inflatable Dock Fender, 1/2, White**

Code	Description	Weight (kg)
72347	Empty	2,5
72492	Foam Filled	4

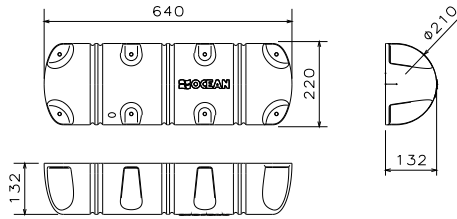

**Inflatable Dock Fender, 3/4, White**

Code	Description	Weight (kg)
72346	Empty	3
72493	Foam Filled	5

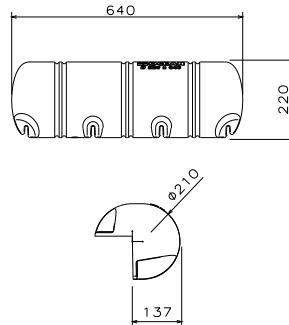

Anchoring, Docking & Mooring

**Dock Fenders**

The Dock Fender, as well as the rest of the OCEAN solid fender series, is manufactured with Flexible Integral PU Skin Foam technology. It is a dock fender that cannot deflate in any way, under any circumstances. It has the best shock absorption and lifetime performance in class, providing exceptional dock and boat protection. It is the ideal fender for dock fending, fitting perfectly in every dock by placing the clip-ons on the dock and then easily and safely attaching the fender with the dock. Can be also installed on boats that require a permanent means of protection, such as pilot or patrol boats, as they come in very close proximity with other boats due to the nature of their operation.

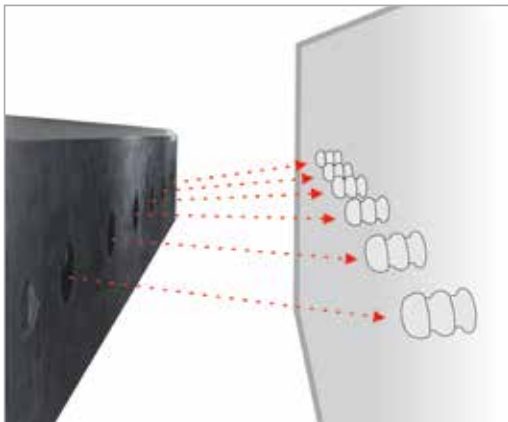

1005x167x160mm



Code	Description
472465	OCEAN Dock Fender, curved-ending, Navy blue
472466	OCEAN Dock Fender, Navy blue
472467	OCEAN Clip-on for Dock Fender

**Mooring & Marking Buoys**

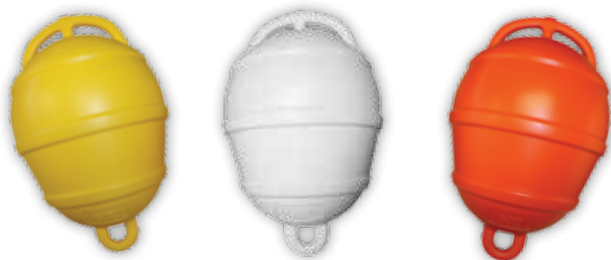

**Mooring Buoy, Rigid Plastic**

Code	Colour	Diameter (mm)	Height (mm)	Buoyancy	
				Overall (kg)	In use (kg)
16389	Yellow	250	390	9,5	4,5
16387	White				
16388	Orange				

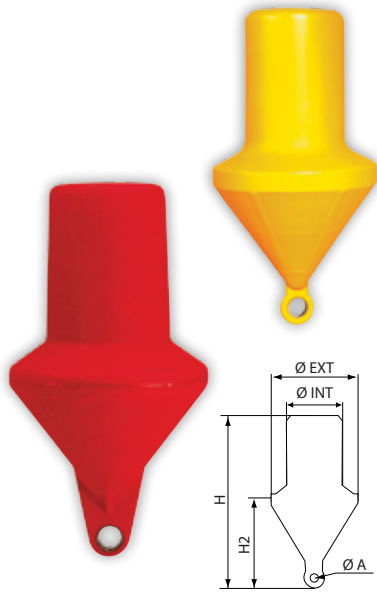

## Marking Buoy, Cylindrical

Made of rigid plastic. A metal eyelet reinforces the ring.

Code	Use	Colour	Description	Dimensions					Buoyancy	
				Ø Ext (mm)	Ø Int (mm)	H (mm)	H2 (mm)	Ø A (mm)	Overall (kg)	In use (kg)
16433	Portside channel marking	Yellow	Empty	400	250	740	363	38	38	14
31928		Red								
16434		Yellow	Foam filled							
31312		Red								
43404	Large size for channel entrance Portside side	Yellow	Empty	800	510	1610	790	55	290	110
43405		Red								
16436		Yellow	Foam filled							
35628		Red								

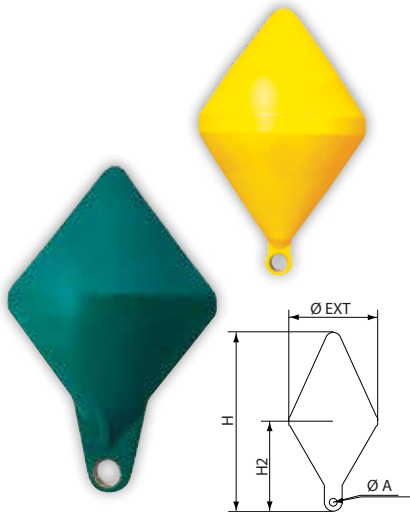

## Marking Buoy, Bi-conical

Made of rigid plastic. A metal eyelet reinforces the ring.

Code	Use	Colour	Description	Dimensions				Buoyancy	
				Ø Ext (mm)	H (mm)	H2 (mm)	Ø A (mm)	Overall (kg)	In use (kg)
16440	Starboard channel marking	Yellow	Empty	400	640	363	55	30	14
31929		Green							
16442		Yellow	Foam filled						
31311		Green							
43418	Large size for channel entrance. Starboard side	Yellow	Empty	800	1610	770	55	200	100
43420		Green							
16443		Yellow	Foam filled						
35629		Green							

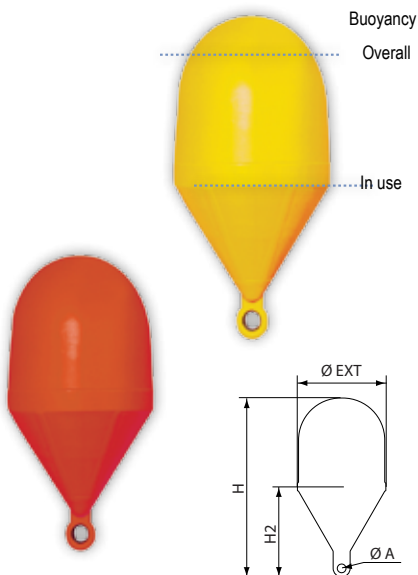

## Marking Buoy, Spherical

Made of rigid plastic. A metal eyelet reinforces the ring.

Code	Use	Colour	Description	Dimensions				Buoyancy	
				Ø Ext (mm)	H (mm)	H2 (mm)	Ø A (mm)	Overall (kg)	In use (kg)
16427	Marking the limits of reserved areas	Yellow	Empty	400	660	32	55	45	14
16428		Yellow	Foam filled					42,5	12,5
35750		Red	Empty					45	14
43411	Outer rim of the 300 m coastline	Yellow	Empty	800	1610	810	55	412	102
11673		Yellow	Foam filled					400	90





**Mooring Buoy, Bi-conical, Rigid Plastic**

UV-resistant

Code	Colour	Diameter (mm)	Height (mm)	Buoyancy	
				overall (kg)	in use (kg)
43433	Yellow	220	540	5,5	2,7
16412	White				
16413	Orange	280	640	10	5
43431	Yellow				
43430	White	320	750	24	12
43429	Orange				
43427	Yellow	520	1070	61	30
16414	White				
16415	Orange	520	1070	61	30
30631	Yellow				
16416	White	520	1070	61	30
16417	Orange				



Anchoring, Docking & Mooring

**Mooring Buoy, Bi-conical, with Foam & Galvanized Steel Rod**

UV resistant

Code	Colour	Diameter (mm)	Height (mm)	Buoyancy	
				Overall (kg)	In use (kg)
43441	Orange	320	660	18	9
43442	White				
43444	Orange	320	880	18	9
43445	White				
43447	Orange	520	1030	58	29
43448	White				



**Marking Buoy Mussel Farming, HDPE**

High-density polyethylene, UV-resistant

Code	Colour	Diameter (mm)	Height (mm)	Buoyancy	
				Overall (kg)	In use (kg)
197451	Black	530	1000	65	32
197450	Black	530	1200	110	55
197449	Black	530	1400	150	75



**Surface Float with Hole, Round**

Polyethylene

Code	Colour	Diameter (mm)	Rope Diameter (mm)	Buoyancy	
				Overall (g)	In use (g)
43952	Orange	45	7	58	29
43956		50	8	62	31
43960		57	8	71	35
43970		75	12	95	47
43971	White	75	12	95	47



**Surface Float with Hole, Spherical**

Suitable for fitting marker flag

Code	Colour	Diameter (mm)	Rope Diameter (mm)	Buoyancy	
				Overall (g)	In use (g)
43399	Yellow	190	19	1,8	0,9
16384	Orange				
16383	White				
43397	Yellow	260	28	8,5	4,2
16386	Orange				
16385	White				





Anchoring, Docking & Mooring



### Anchor Marking Buoy with LED Light & Retroreflective Tape

It marks the exact position of the anchor. It is supplied with LED- type flashlight, which operates with one D-type alkaline battery and with a sensor, to flash only during the night hours (3 flashes per minute). Fitted with SOLAS approved retroreflective tape, to give extra help on locating the buoy at night. Material: HDPE.

Code	Diameter (mm)	Height (mm)	Weight (kg)
636020	200	570	1



Led Light

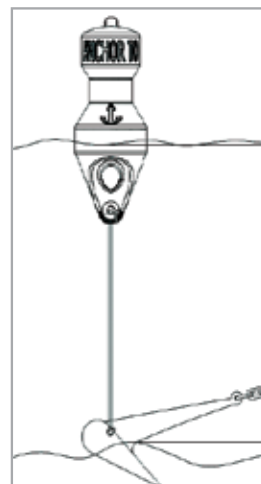

### Anchor Marking Buoy with Retroreflective Tape & Line 11m

It marks the exact position of the anchor with a lead counterweight that self-adjusts the line length with depths between 4 and 10 m. SOLAS approved retroreflective tape to give extra help on locating the buoy at night. It helps to retrieve a fouled anchor by lifting it up from the anchor crown. Easy-to-use and stow it away in the anchor peak. Material: HDPE.

Code	Diameter (mm)	L line (m)	Height (mm)	Weight (kg)
197765	200	11	507	2

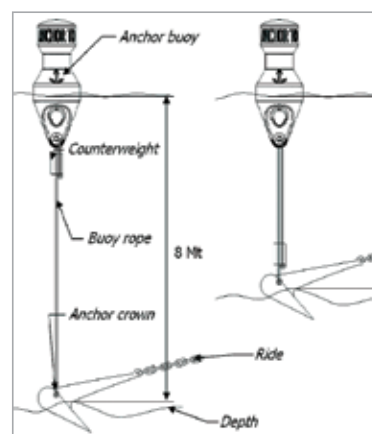

### Sports Buoy

Sports Buoy is made of high-quality PVC material. This small but durable inflatable buoy is the perfect marker for a beach, a waterski course or any area that requires marking. OCEAN Sports Buoy meets the American Water Ski Association specifications. With a durable rope hold to fasten any line.

Code	Colour	L (mm)	H (mm)	Weight (kg)
72450	Red	200	230	0,6

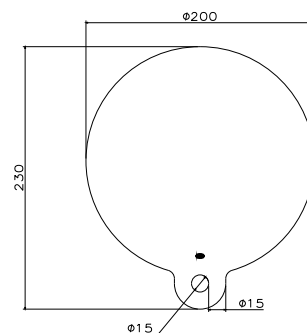



### Diver Buoy

It is ideal for diving with cylinders. It is easy-to-use for the diver, since it is especially designed so as to facilitate the diver's moves without jeopardizing his safety. The red buoy is folded and attached with a rope (6m) inside the blue case; the case has a sewn black plastic clip on, which offers the ability to the diver to fasten the buoy on his suit for easy carrying. Additionally, the case features a whistle to use in any emergency. The buoy is made of soft PVC, 0.3mm thick, while the case is made of 1000D Polyester with PVC film, 0.5mm thick.

**Dimensions:** L 20cm W 8cm (packed)  
H 145cm W 15cm (inflated)

#### Instructions of Use

Open the case and release the buoy. Use the cylinder to provide the buoy with a small quantity of air. In this way, the pressure of the air along with the pressure of the water will make the buoy to inflate and pop up on the water surface, warning the boats that a diver will soon float at the specific point.

Code | 70017



### Torpedo Diving Marker Buoy "Safe Dive", Diam. 28cm, Length 88cm

Code | 97816



### Torpedo Diving Marker Buoy "Safe Dive", Reinforced, with 20m Rope

Code | 97813



### Small Round Marker Buoy "Safe Dive", Diam. 30cm, Height 50cm

Code | 97814



Anchoring, Docking & Mooring

### Race Mark Buoy

This mark buoy has been especially designed to meet the demands of races. It features one inflation & deflation valve and one transparent pocket (69 x 58 cm) which can be used for advertising purposes. There are also 4 attachment points for the anchor line. In order to absorb the pulling forces of the latter, LALIZAS Race Mark Buoy is fitted with a special net. When deflated, it is very easy to carry, despite its size (height: 1.5 m, diameter: 0.90 m). Made of UV-resistant PVC, it has bright yellow colour for high visibility.

Code	51030
Model	Cylindrical
Diameter (m)	0,9
Height (m)	1,5
Inflated Weight (kg)	4
Transparent Pocket	1

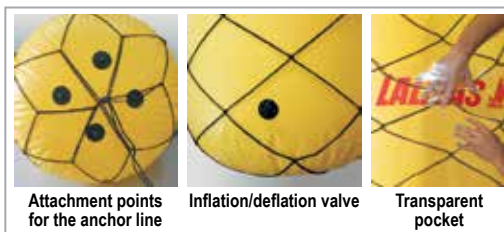

Attachment points for the anchor line

Inflation/deflation valve

Transparent pocket





Anchoring, Docking & Mooring

## Telescopic Hook with Single End, Anodised Aluminium, Black



Code	Length (cm)	Ø Shaft (mm)
16593	114 to 192	30

## Floating Hook with Single End, Anodised Aluminium, Black



Code	Length (cm)	Ø Shaft (mm)
12517	120	25
12518	180	
12519	240	

## Floating Hook with Double End, Anodised Aluminium, Black



Code	Length (cm)	Ø Shaft (mm)
44259	216	30

Soft PVC Cover



## Floating Hook with Double End, White Aluminium, Grey



Code	Length (cm)	Ø Shaft (mm)
44263	180	30

Soft PVC Cover



## Hook with Double End, Black



Code	Length (cm)	Ø Shaft (mm)
50030	147	25
50040	175	

Soft PVC Cover



## Telescopic Hook with Double End, Aluminium, Black



Code	Length (cm)	Ø Shaft (mm)
50060	67 to 101	25/30
50050	118 to 196	

Soft PVC Cover



## Telescopic Hook with Double End, Anodised Aluminium, Grey



Code	Length (cm)	Ø Shaft (mm)
44252	118 to 196	25

Soft PVC Cover



## Telescopic Hook with Double End, White Aluminium, Grey



Code	Length (cm)	Ø Shaft (mm)
44261	118 to 196	30

## Floating Hook with Single End, Pine, Black



Code	Length (cm)	Ø Shaft (mm)
16591	120	30
16592	180	30

Boat Hooks

All boat hooks are manufactured following the highest standards. The hooks are made of Nylon and the poles of high-quality anodised aluminium for longer life. The boat hook head (57343) is also available. It is lighter, reinforced for extra strength, with a wider opening, which allows you to capture objects more easily. This hook head can be used with the plain (57340) or telescopic tubes (57341 - 57342), which are sold separately.

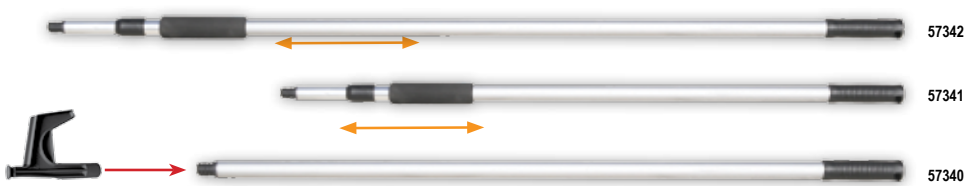

Code	Description	Diameter (cm)	Length (cm)	
			Min	Max
57340	Aluminum Tube for hook/broom	2,5	130	
57341	Aluminum Tube Telescopic for hook/broom	2,2 - 2,5	110	175
57342		2,2 - 2,5	170	305
57343	Hook with Thread - Black	2,2	-	



Hook, Ø25mm, Plastic, Black

Code | 50180



Handle, Ø25mm, Plastic, Black

Code | 50908



Handle, Ø30mm, Plastic, Black

Code | 50100



Handle, Ø35mm, Plastic, Black

Code | 50110



Female Hook with Single End, Plastic, Ø 30mm, Black

Code | 16590



Female Hook with Double End, Plastic

Code	Ø int. (mm)	Colour
44249	25	Black
44246	30	

Double Hook with Thread Ø30mm, Plastic, Black



Code | 44243

Female Hook with Single End, Plastic, Ø25mm, Black



Code | 38579

Support Clip, Plastic, Black



Code	Diameter (mm)
16702	16
16705	19
16703	25
16704	30
16707	50

Adjustable Support Clip, Plastic



Code	Colour
45229	White
45230	Black

Adjustable Double Support Clip, Plastic, Black



Code | 45217

Folding Support Clips, Plastic, White, Set



Code	A (mm)	B (mm)	Ø C (mm)
196072	72	82	30

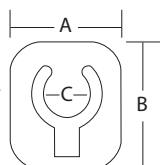

Screwed Support Clip, Plastic

Code	Diameter (mm)	Colour
45191	15	White
45192		Black
45197	20	White
45198		Black
45203	25	White
45204		Black
45209	30	White
45210		Black
45215	35	White
45216		Black
45235	40	White
45236		Black
45241	45	White
45242		Black





Anchoring, Docking & Mooring

## Rope Ladder

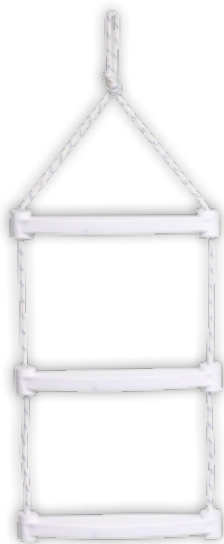

Code	50042	50043	50044
Steps	2	3	4
Height (cm)	62	80	102
Width (cm)	35	35	35
Weight (gr)	250	400	500

## Aluminium Ladder

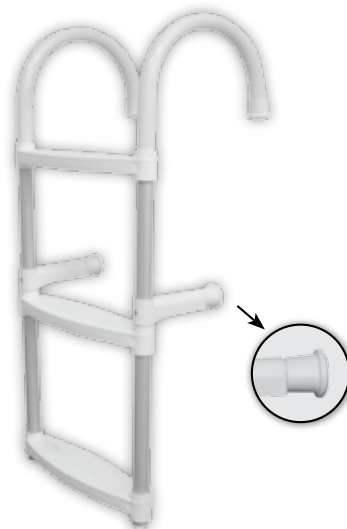

Code	50032	50033	50034	50035
Steps	2	3	4	5
Height (cm)	55	83	110	136
Width (cm)	35	35	35	35
Weight (gr)	950	1200	1550	1800

## Inox Ladder



Code	50053	50054	50055
Steps	3	4	5
Height (cm)	83	113	136
Width (cm)	35	35	35
Weight (gr)	1920	2200	2900

### Step for Aluminium & Inox Ladder, White



Code | 50160

### Step for Aluminium & Inox Ladder, Black



Code | 50170

### Step for Rope Ladder, White



Code | 50150

## Key Hole Plate for Ladders

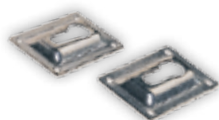

Code | 00636

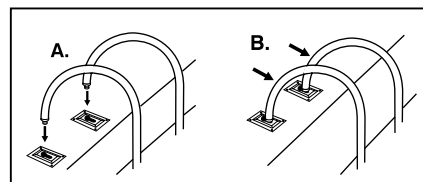
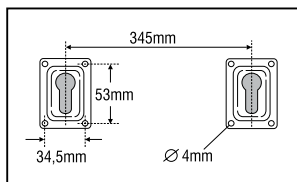

## Key Hole Plate, without Base



Code | 70647

## Spare Hinge for Ladders



Code | 70646

## Key Hole Plate



Code | 99527

## Mounting Bracket for Ladders



Code	70613	70614
Diameter (mm)	22	25



Foldable Ladder, Inox 316, 180°

Code	A (mm)	B (mm)	Steps
55695	1050	405	2 + 2
55696	1300	655	3 + 2
55697	1300	405	2 + 3
55698	1550	655	3 + 3

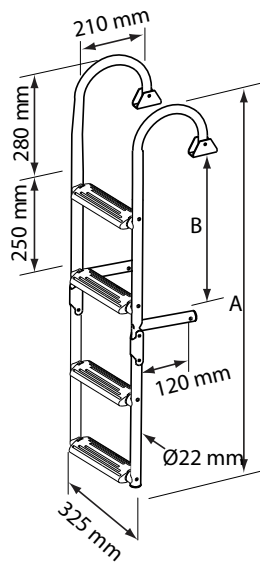

Adjustable Steps

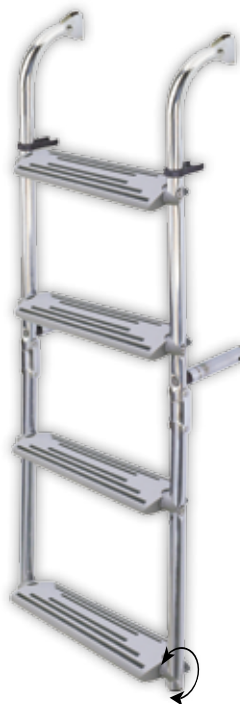

Foldable Ladder, Inox 316, 90°

Code	A (mm)	B (mm)	Steps
55699	650	140	1 + 2
55700	900	390	2 + 2
55701	1150	640	3 + 2
55702	1150	390	2 + 3
55703	1400	690	3 + 3

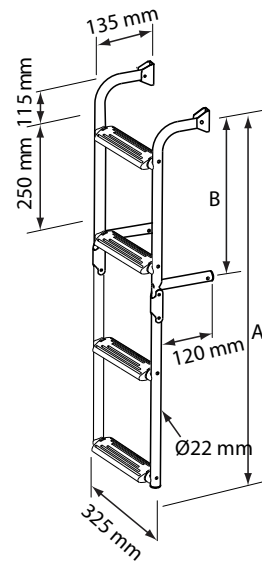

Adjustable Steps

Bow Ladder, 3 Steps, Inox 316

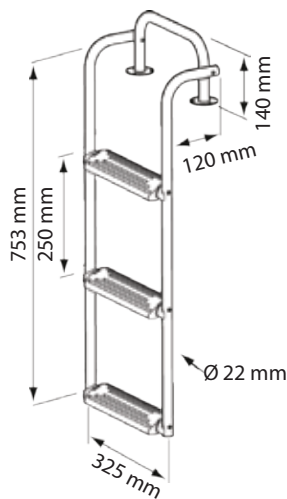

Adjustable Steps

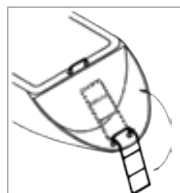

Code | 55694

Raft Ladder, 2 Steps, Inox 316

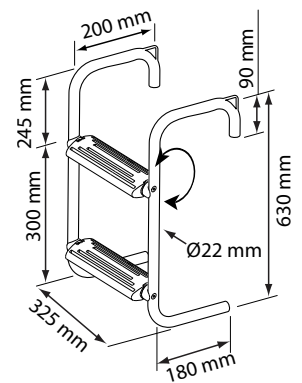

Adjustable Steps

Code | 55706



Anchoring, Docking & Mooring



Anchoring, Docking & Mooring



**Foldable Ladder for Narrow Transom, 2+2 Steps, Inox 316, 180°**

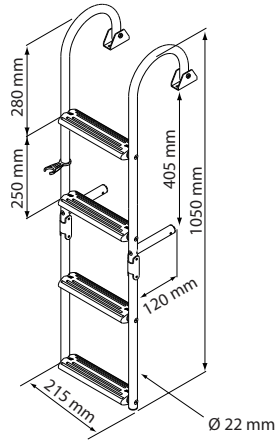

Code | 30535

**Foldable Ladder for Narrow Transom, 2+1 Steps Inox 316**

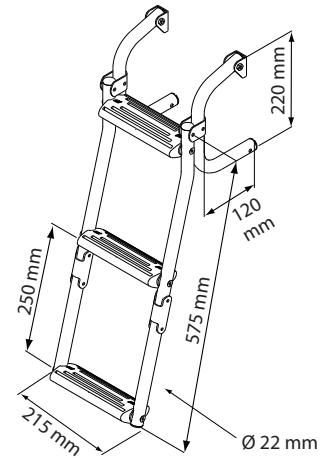

Code | 29398

**Foldable Ladder for Narrow Transom, Inox 316, 90°**

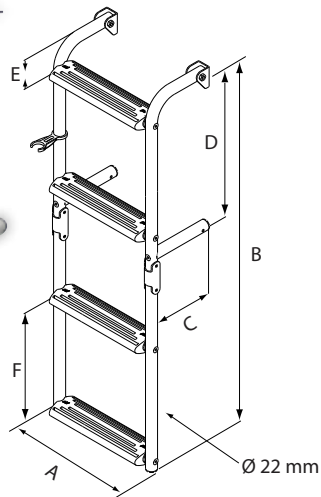

Code	A (mm)	B (mm)	C (mm)	D (mm)	E (mm)	F (mm)	Steps
30536	215	835	120	370	70	250	2 + 2
36275	215	705	120	205	160	250	1 + 2

**Fixing Plate for Ladder, Inox**



Code | 27073

**Ladder Support Base, Long**

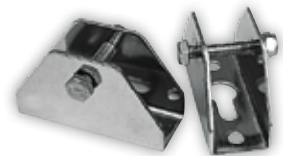

Code | 12587

**Connection Ladder, without Base, Ø22mm**



Code | 02442

**Connection Ladder, T Shape, Ø22mm**



Code | 02443

**Ladder Support Base, Narrow**



Code | 29999

**Hinge for Folding Ladder, Ø22mm**

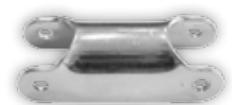

Code | 02439





**Add on Step, Inox 316**

Code | 12572



**Footrest, Inox, Ø22mm, 440x120mm**

Code | 44213



**Round Base, 90°, Inox 316, Ø22mm, Base Ø54mm**

Code | 70616



**Kit for Adjustable Steps, 2 pcs**

Code | 30537

**Ladder Step with Fitting, Grey, Set**



Code	Length (mm)	For tube
15684	180	Ø 22
15680	260	Ø 22

## Folding Ladder for Inflatable Boats, Aluminium

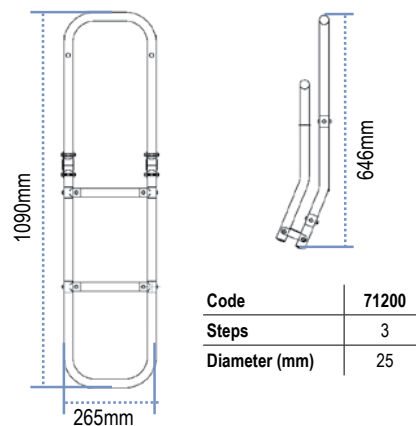
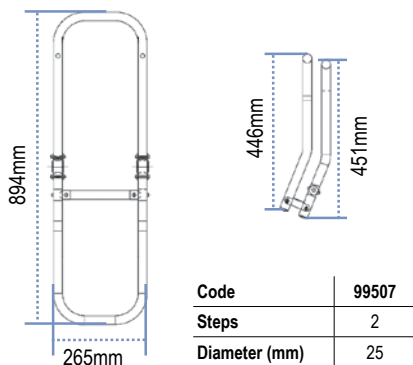

## Folding Ladder for Transom, Inox 316

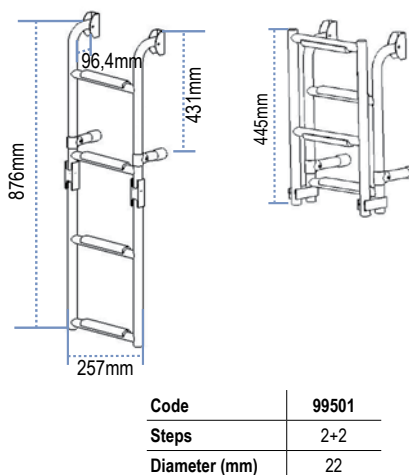
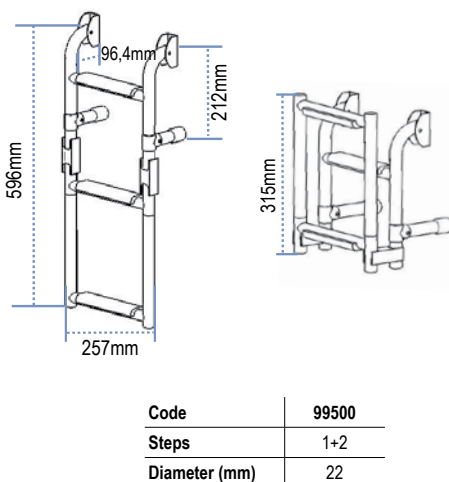

Anchoring, Docking & Mooring



Anchoring, Docking & Mooring

## Folding Ladder, Inox 316

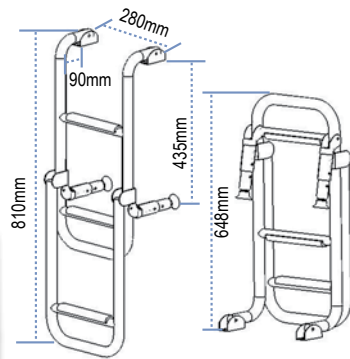

Code	70146
Steps	1+2
Diameter (mm)	25

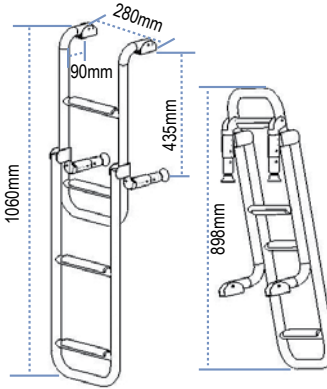

Code	70088
Steps	2+2
Diameter (mm)	25

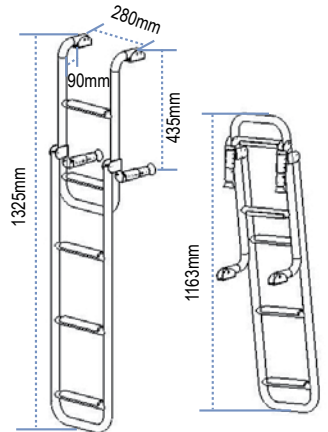

Code	70147
Steps	2+3
Diameter (mm)	25

## Folding Ladder for Gunwale, Inox 316

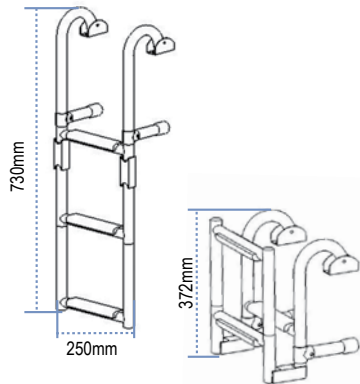
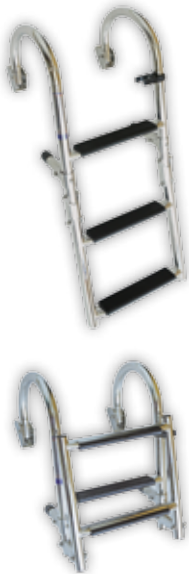

Code	99497
Steps	1+2
Diameter (mm)	22

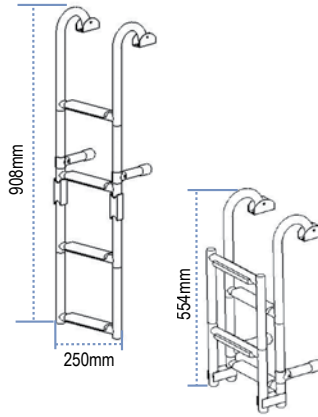

Code	99498
Steps	2+2
Diameter (mm)	22

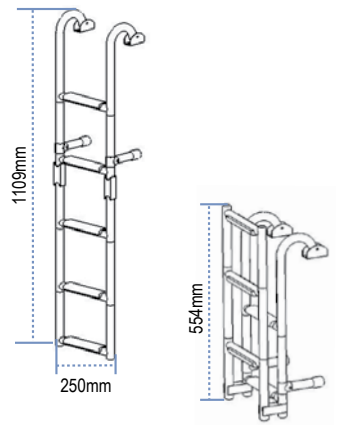

Code	99499
Steps	2+3
Diameter (mm)	22

## Telescopic Ladder for Platform, Inox 316

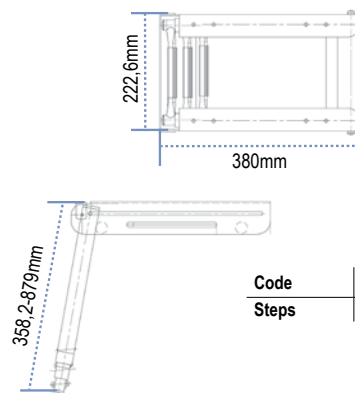

Code	99503
Steps	3

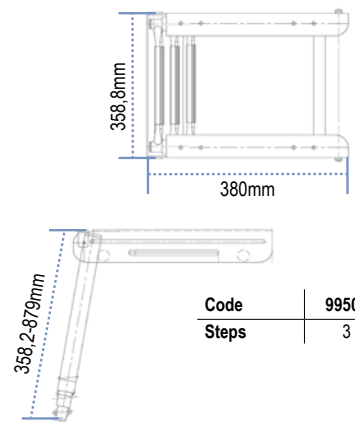

Code	99504
Steps	3

Folding Ladder, Inox 316

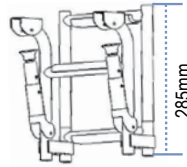
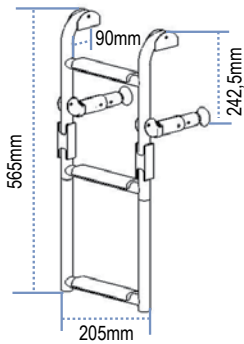

Code	70089
Steps	1+2
Diameter (mm)	25

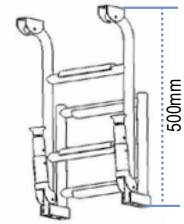
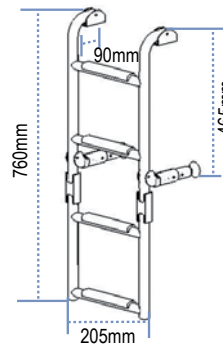

Code	70148
Steps	2+2
Diameter (mm)	25



Anchoring, Docking & Mooring

Folding Ladder for Platform, Inox 316

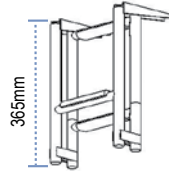
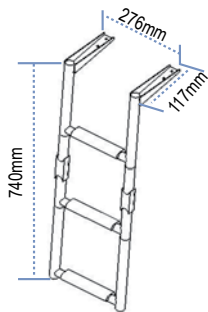

Code	99505
Steps	1+2
Diameter (mm)	22

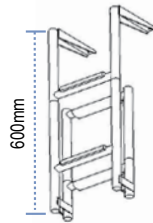
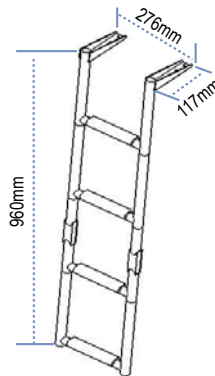

Code	99506
Steps	2+2
Diameter (mm)	22

Telescopic Ladder, Inox 316

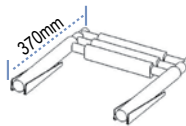
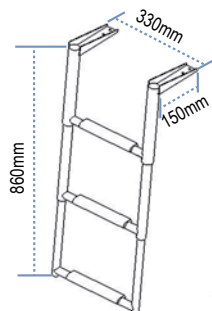

Code	70610
Steps	3

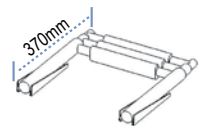
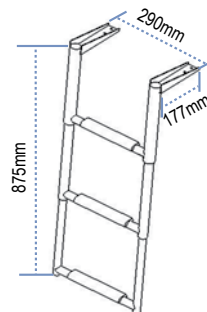

Code	74328
Steps	3

## Boarding Ladders & Accessories



Bow Ladder, Inox 316

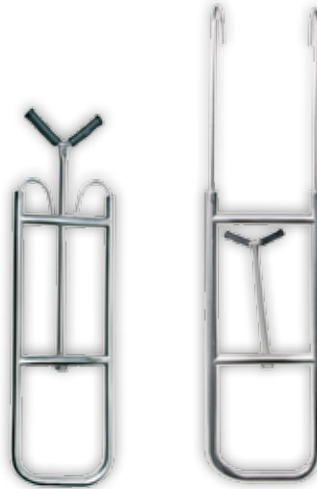

Code	70644
Steps	3
Diameter (mm)	25
Width (mm)	230
Length (mm)	1060

## Platforms & Gangways



Platform Ladder, Inox 316, with 2 Plastic Steps

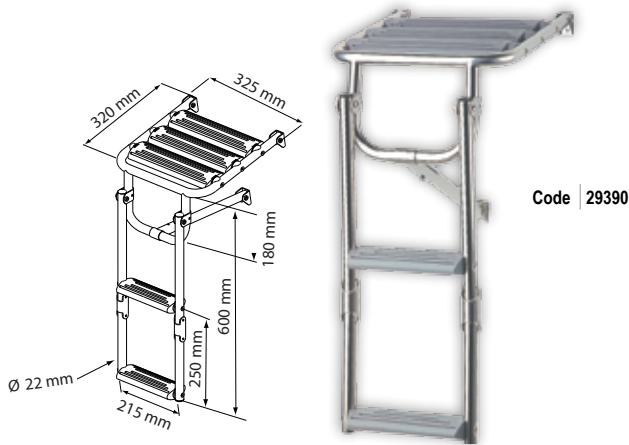

Immersed Platform Ladder, Inox 316

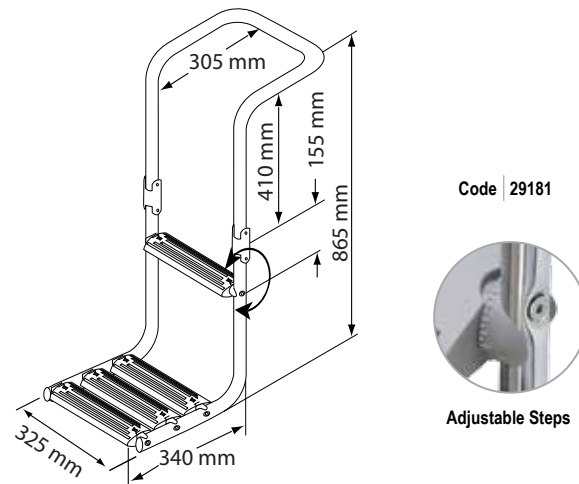

Wooden Platform with Inox 316 Frame

Code	99512	99513
Diameter (mm)	25	
Width (mm)	210	270
Length (mm)	390	
Wood	Teak	



Wooden Platform with Inox 316 Frame

Code	99509	99510
Diameter (mm)	25	
Width (mm)	450	
Length (mm)	390	500
Wood	Teak	



Wooden Platform with Inox 316 Frame

Code	99511
Diameter (mm)	25
Width (mm)	600
Length (mm)	550
Wood	Teak

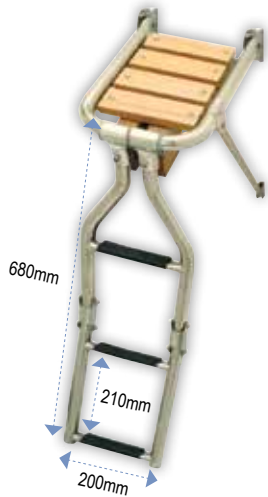

**Wooden Platform with Inox 316 Ladder**

Code	99516	99517
Width (mm)	210	270
Length (mm)	390	
Wood	Teak	

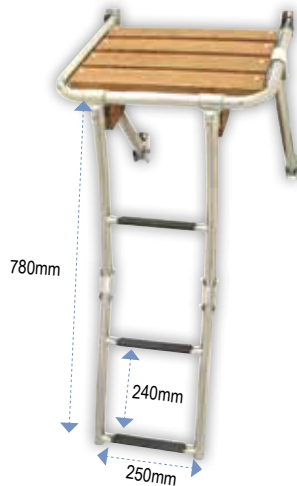

**Wooden Platform with Folding Inox 316 Ladder**

Code	99514
Width (mm)	450
Length (mm)	390
Wood	Teak



**Wooden Platform with Telescopic Inox 316 Ladder**

Code	99515
Width (mm)	450
Length (mm)	390
Wood	Teak

**new**

**Gangway Carbon, Folding, 220x35cm, 7,9Kg**

Code | 74706

**Wooden Gangway with Aluminium Frame, 190x38cm, 11,8kg**

Code | 72666



**Wooden Gangway, 2,4m**

Gangway teak, unstated, rigid.

Dimensions: 2400x270x39mm  
Weight: 12kg

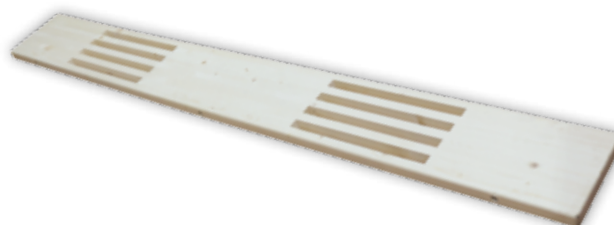

Code | 42073



# Boats, Engines & Accessories



Inflatable Boats	117-118	Sacrificial Anodes	148-151
Inflatable Boat Accessories	119-121	Fuel Tanks & Accessories	152-157
Paddles & Spare Parts	121-125	Fuel Hoses & Connectors	157-159
Inflation Pumps & Accessories	125-126	Tank Vents	159-160
Deck Fillers	126-128	Engine Blowers	160-161
Roll Bars	128	Oil Change Equipment	161
Outboard Engines	129-131	Exhaust Components	161
Propellers	132	Drain Plugs	162
Outboard Engine Accessories	132-135	Windshield Motors & Arms	162-164
Oils, Valvolines & Additives	136	Marine Horns	164-166
Helms & Steering Systems	136-137	Instruments & Accessories	167
Steering Wheels & Accessories	137-138	Optimist Accessories	167-169
Cable Boots	138-139	Davits	169
Engine Controls & Accessories	139-140	Manual & Electric Winches	170
Engines Control Cables	140	Trailer Accessories	170-172
Impellers	140-148	Trailer Lights & Sockets	172

At MARINA Stores, you can find the inflatable boats of the leading Italian manufacturer, ARIMAR, and choose the one that fully meets your needs. Combine your inflatable boat with a HIDEA outboard engine for unique sea excursions. A reliable and efficient solution that will never let you down!

The maintenance of your engine is also important, so get the necessary equipment and accessories to keep your engine running at all times and performing at its best.

In terms of your boat's transportation, you will find the best boat trailer parts in order to maintain the longevity of your boat trailer and avoid any damages.



**ARIMAR is a leading manufacturer of recreational inflatable boats, synonymous with safety, reliability as well as the excellent Italian design with attention to details.**

With a 30-year of experience in the market, ARIMAR offers durable and functional inflatable boats, which have been manufactured with cutting-edge technology and sophisticated style.

ARIMAR inflatable boats are divided into the following two categories, the **folding ones** and the **rigid hull ones**.

The **folding inflatable boats** are made of high-quality materials and feature heat-sealed tubes made of double-coated 1110 DTEX PVC, guaranteeing a sturdier durable product. They are designed to occupy as minimum space as possible on board. Once they are deflated, they can be easily stowed in a convenient bag for easier transportation. Our folding inflatable boats are the best option for anyone looking for top comfort in a small-sized inflatable boats, without sacrificing quality and durability.

The **rigid hull inflatable boats** are made with a different manufacturing technology, which results in an ideal combination of the fiberglass hull with inflatable tubes. Tubes can be made of PVC or Hypalon Neoprene upon request. The PVC material covers all the textile parts, protecting them from sunlight and salt. Their high quality, durability, and excellent Italian design, make them the best option even for the most demanding users, for both autonomous use or as a tender.

Boats, Engines & Accessories

### ROLL - Folding, with Wooden Slats

Made of PVC, the Roll line is the best option for anyone looking for a small sized, comfortable and easy-to-handle inflatable boat. Three-chamber tubes make the craft sturdy, stable and seaworthy. Flooring consists of solid wooden slats. The standard bench is specifically designed to provide yachtsmen with the best possible comfort. All models in the Roll line can be easily and quickly stowed due to their special design, as well as easily transportable in a convenient and lightweight bag. Roll is the best choice for any type of boats, and suggested especially for small yachts with limited stowage space. All models in the Roll line are quickly operational with their airtubes being simple and fast to inflate.

Code	501412	501413	501414
"ROLL"	ROLL 185	ROLL 210	ROLL 240
Passenger Capacity			
Max. Power (HP)	4	5	6
Engine Shaft	S	S	S
Floor	Wooden slats (2)	Wooden slats (3)	Wooden slats (3)
External Dim. (cm)	185 x 155	210 x 155	240 x 160
Internal Dim. (cm)	102,5 x 75	127,5 x 75	154 x 80
Tube Diameter (cm)	40	40	40
CE Category	-	-	-
Compartments	3	3	3
Standard Equipment	Repair kit, couple of oars, inflator, wooden bench		
Weight (Net*) kg	16	18	25,5

**THE BEST OPTION FOR A SMALL-SIZED, COMFORTABLE & EASY-TO-HANDLE INFLATABLE BOAT**



**ROLL**

\*Net weight without equipment

## SOFT LINE - Folding, with Inflatable Floor

The Soft Line model is the most popular among ARIMAR folding inflatable boats thanks to its high-pressure inflatable flooring. The inflatable keel reproduces the traditional V-shaped hull and provides easy handling, stable supports and extreme comfort thanks to the inflatable flooring. All models can be easily stowed and transported. Moreover, the Soft Line inflatable boats are significantly much lighter than other ones in the market of the same size, making them easier to manage. Easy to steer even in the roughest sea, it offers excellent cruising performance. ARIMAR "Easy System" technology allows all boats of all sizes to fold, without having to extract the flooring, making disassembly much easier.

Code	501421	501422	501423
"SOFT LINE"	SOFT LINE 210	SOFT LINE 240	SOFT LINE 270
Passenger Capacity			
Max. Power (HP)	5	6	10
Engine Shaft	S	S	S
Floor	Inflatable	Inflatable	Inflatable
External Dim. (cm)	210 x 155	240 x 160	270 x 160
Internal Dim. (cm)	127,5 x 75	154 x 80	170 x 76
Tube Diameter (cm)	40	40	42
CE Category	-	-	D
Compartments	3+1+1	3+1+1	3+1+1
Standard Equipment	Repair kit, couple of oars, inflator, wooden bench		
Weight (Net*) kg	22	25	28,50

THE MOST POPULAR ONE AMONG OUR FOLDING INFLATABLE BOATS



SOFT LINE

## CLASSIC - Folding, with Aluminium Floor

The Classic line includes inflatable boats with inflatable tubes and inflatable keels which reproduce the traditional V-shaped hull. The innovative walkable aluminium surface offers great sturdiness, as it makes the inflatable boat stable and resistant when at sea. All Classic inflatable boats can be easily stowed on board. A perfect combination of functionality and safety, suitable for all boat owners. Additionally, their features as well as their high-quality materials make them the most durable ones in their category, even in the roughest conditions at sea.

Code	501416	501417	501418	501419
"CLASSIC"	CLASSIC 240	CLASSIC 270	CLASSIC 320	CLASSIC 360
Passenger Capacity				
Max. Power (HP)	6	10	15	25
Engine Shaft	S	S	S	S
Floor	Aluminium	Aluminium	Aluminium	Aluminium
External Dim. (cm)	240 x 160	270 x 160	320 x 170	360 x 170
Internal Dim. (cm)	154 x 80	170 x 76	220 x 86	258 x 82
Tube Diameter (cm)	40	42	42	44
CE Category	-	D	D	C
Compartments	3+1	3+1	3+1	3+1
Standard Equipment	Repair kit, couple of oars, inflator, wooden bench			
Weight (Net*) kg	34,80	38	47,50	53,40

STEADINESS & SAFETY AT ITS FINEST



CLASSIC

## HERCULES - with Fiberglass Floor

Hercules line is manufactured with a sturdy fiberglass hull for advanced stability, safety, and speed. Highly performing, all inflatable boats of this line have wide spaces, specially designed to provide passengers with the most comfortable cruising experience. Hercules line boats can be used either as autonomous ones or as tenders. Designed to cover even the most demanding needs, these elegant and robust inflatable boats are the best choice for your coastal trips.

Code	501637	501638	501639	501640
"HERCULES"	HERCULES 200	HERCULES 240	HERCULES 290	HERCULES 310
Passenger Capacity				
Max. Power (HP)	4	5	7	15
Engine Shaft	S	S	S	S
Floor	Fiberglass	Fiberglass	Fiberglass	Fiberglass
External Dim. (cm)	202 x 147	245 x 160	290 x 154	310 x 154
Internal Dim. (cm)	124,5 x 71,5	172 x 70	210 x 70	234 x 70
Tube Diameter (cm)	36	43	43	43
CE Category	-	-	D	D
Compartments	3	3	3	3
Standard Equipment	Repair kit, couple of oars, inflator, wooden bench			
Weight (Net) kg	37	50	65	70

ONE-OF-A-KIND COMFORT & PERFORMANCE



HERCULES





**Flexy**  
Emergency  
NavLights

- 3NM Visibility
- 12 hours battery life
- Easy set up
- Water resistant



**LALIZAS FLEXY EMERGENCY NavLights Set of 3pcs**

Code | 72663



**Suction Base for LALIZAS FLEXY EMERGENCY NavLights**

Code | 72665



**Rowlock Socket for Inflatable Boat, Grey**

Code | 57333



**Handle for Inflatable Boat 24x9,5cm, Grey**

Code | 57332



**Footpump**

Code	11498	50952
Liters	3	5

**Key for Valves**



Code | 98789



**new**



**Heavy Duty Handle for Inflatable Boat, 220x90mm, Grey**

Code | 74448



**Rowlock Socket with Metal Pin, Grey**

Code | 74447



16688



95781  
95782



43462  
43463



43468



43469



**Plug for Drain Socket, White**

Code | 16713



16689



43478  
43477



16691



16690



16797

**Drain Socket with plug**

Code	Specifications	Colour	Flange Dimensions (mm)	Overall Height (mm)	Height of Socket (mm)	Cut-out Diameter (mm)	Depth Below Deck (mm)	Mini Internal Diameter (mm)
16688	Plain	White	48 x 36	28	19,5	27	15	19
16689	With 2 holes	White						
43462	With captive plug	White	54 x 33	55	25	27	20	19
43463	With captive plug	Black						
95781	With captive plug	White	60x30	52	23	27	18	19
95782	With captive plug	Black						
43468	With captive plug	White	Ø 40	55	25	27	20	19
43469	With captive plug	Black						
43478	With 4 holes	Black	Ø 43	38	27	25	22	16,5
43477	With 4 holes	White						
16691	With captive plug	White	Ø 46	63	27	28	21	19
16690	Plain	White						
16797	"Fast Lock"	White	Ø 43	107	96	27	91	19



Boats, Engines & Accessories

## Inflatable Boat Accessories

new



**Non-return Drain Valve Set, with Plug for 25mm Transom, Grey**

Code | 74449

**Captive Plug with O-Ring for Drain Socket**

Code	Colour
45276	White
45277	Black



**Nuova Rade**

**Hook for Inflatable Boat Cover**

Rope or shock cord 8 mm max.  
Length 40 x height 40 mm



Code	Colour
28112	Black
44015	White
44016	Grey

**Buoyancy Tank Drain Socket with Captive Plug**

Internal diam.: 18 mm  
External diam.: 23 mm

Code | 16687



new



**End Block, Grey**

Code | 198202



**Inflating Valve Standard**

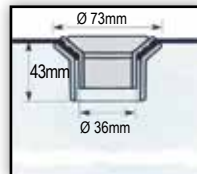

Code	98788	98966
Colour	Black	Grey

new



**ARIMAR**

**Bow Bag**

Code | 501813

Boats, Engines & Accessories

### Under Seat Storage Bag Ténére Sit & Store

The under seat storage bag provides you with the extra storage space that is so necessary on any boat. It is made of PVC Tarpulin and has been designed to fit to any seat. It also features a shoulder strap which allows you to carry the bag when you leave the boat. The top of the bag is padded to "soften the ride" on the wooden seat. It is water resistant, while the waterproof zipper keeps the storage area dry. It is available in grey colour.

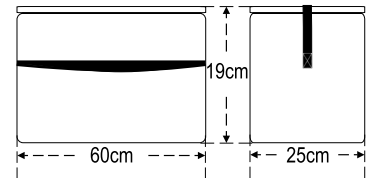

Code | 70895



### Dry Briefcase

LALIZAS Dry Briefcase has been designed especially for the protection of your boat's documents. Made of durable vinyl, it has clear front panel, which allows you to see the content of the bag. Furthermore each dry briefcase has a lanyard loop. The Dry Briefcase has the advantage of floating in the water, depending, however, on the air captured and the weight of the contents. It features a 100% waterproof seal with velcro.

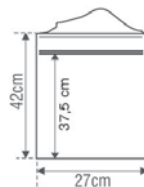

The dimensions shown are when the bag is empty.

Code | 10450



The ultimate protection for your boat's documents

**Boat Mover, 200mm with Pneumatic Wheels**

Code | 99585

- Overall Length: 570 mm
- With 8" pneumatic wheels
- Max load of the tires: 80k



new



Code | 74705

### Repair Kit for Inflatable Boats

It includes:

- PVC Fabric, 2pcs: 150x200mm grey & 150x200mm white
- Neoprene Fabric, 1pc: 150x200mm black
- Glue tube 20gr
- Key for valves



### Repair Kit for Neoprene/Rubber Fabrics

Package includes:

- Cleaner - 30ml
- Hardener/Cross linker - 15ml
- Primer G.O. - 30ml
- Glue (PO 40) - 100ml
- Fabric (neoprene polyester 10x30cm)
- Brush

Application for

- Liferrafts
- Tender boats
- Fenders
- Other neoprene & rubber products



Code | 72437

### Repair Kit for TPU/PVC/EVA Fabrics

Package includes:

- Cleaner - 30ml
- Hardener/Cross linker - 15ml
- Glue (PO 40) - 100ml
- Fabric (Nylon TPU 10x30cm & PVC 10x30cm)
- Brush

Application for

- Liferrafts
- Tender boats
- Inflatable fenders
- Other TPU, PVC & EVA products



Code | 72436





Boats, Engines & Accessories

## Paddles & Spare Parts

### Palm Grip Paddles

Quality aluminum paddles suitable for tenders, canoes and rowing boats. Made of a marine grade aluminum shaft and virtually indestructible polypropylene handle, collars and blades. Special design features include a grab-handle at the end of each blade to aid recovery of a person in the water. Spare blades, collars, handles and rowlocks are available to maintain and extend the life of these products.

		Code	Length (cm)	Diameter (mm)
	<b>Paddle with Removable Blade, Grey</b>	50992	140	35
		50994		
	<b>Paddle with Removable Blade, Black</b>	50993	140	
		50995	150	



new

### Paddle with Removable Blade, Grey



Code	Length (cm)	Diameter (mm)
74585	144,5	35
74586	154,5	
74587	174,5	



### Buoyant Paddle for Liferrafts, Black

Code	Length (cm)	Diameter (mm)
71851	51,5-76,5	25

### Double Paddle, Black

Paddle blade angle 60°



Code	Length (cm)	Diameter (mm)
72198	200	30

## Paddles & Spare Parts



**Paddle with Palm Grip, Black**

Code	Length (cm)	Diameter (mm)
50190	105	25
50200	120	



**Heavy-duty Paddle with Palm Grip, Black**

Code	Length (cm)	Diameter (mm)
50220	135	35
50240	155	

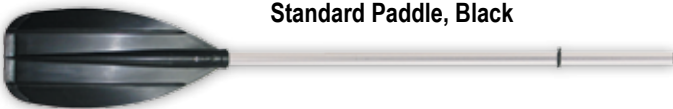

**Standard Paddle, Black**

Code	Length (cm)	Diameter (mm)
50210	130	25
50230	150	



**Paddle, Black**

Code	Length (cm)	Diameter (mm)
50250	160	35
50290	205	
50270	185	
50300	220	

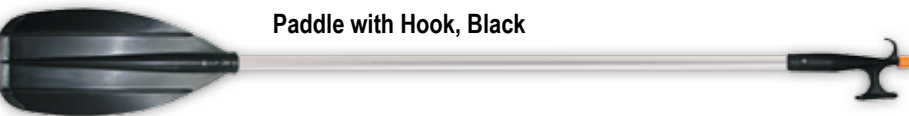

**Paddle with Hook, Black**

Code	Length (cm)	Diameter (mm)
50260	165	25



**Kayak Double Paddle, Black**

Paddle blade angle 60°

Code	Length (cm)	Diameter (mm)
50280	200	25

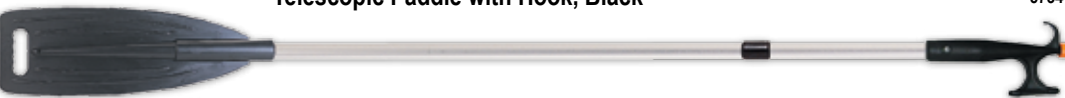

**Telescopic Paddle with Hook, Black**

Code	Length (cm)	Diameter (mm)
57207	156-225	30
57347	122-169	



**Canoe Paddle, Black**

Paddle blade angle 60°

Code	Length (cm)	Diameter (mm)
50310	230	30



**Paddle Jointed with Double Hook, Black**

Code	Length (cm)	Diameter (mm)
44347	141	30



**Paddle Jointed for Inflatable Boat, Black**

Code	Length (cm)	Diameter (mm)
44367	160	35



Paddle Jointed with Collar for Inflatable Boat, Black



Code	Length (cm)	Diameter (mm)
44361	188	35

Kayak Dismountable Paddle, Black



Paddle blade angle 90o

Code	Length (cm)	Diameter (mm)
44343	220	30

Paddle with Double Hook, Black



Code	Length (cm)	Diameter (mm)
44346	140	30

Paddle Telescopic with Double Hook, Black



Code	Length (cm)	Diameter (mm)
44348	143 - 195	30

Paddle Telescopic with Double Hook, Grey



Code	Length (cm)	Diameter (mm)
44349	156 - 203	30
44350	104 - 130	30

Paddle Blade, Ø30mm, 182gr, Black



Code | 02495

Paddle Blade, Ø35mm, 385gr, Black



Code | 00842

Paddle Blade, Ø30mm, 290gr, Black



Code | 50000

Paddle Blade, Ø25mm, 255gr, Black



Code | 00632

Handle for Large Paddle 50220 Ø 35mm



Code | 00843

Palm Grip, Ø 25mm



Code | 00633

Handle, Ø25mm, Black



Code | 50908

Handle, Ø20mm, Black



Code | 50100

Handle, Ø35mm, Black



Code | 50110

Oar Collar Ø35mm, Black



Code | 195578



Paddle End Cap, Int. Ø35mm, Black

Code | 44085

Boats, Engines & Accessories

# Paddles & Spare Parts

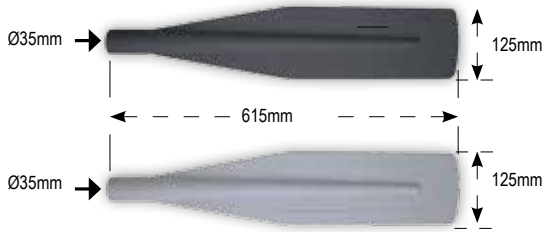

**Blade for Paddles (50992-50995)**

Code	51000	51001
Colour	Grey	Black



**Spring Clip**

Code	50530
------	-------



**Oar Lock with Metal Pin Ø 35mm**

Code	50996	50997
Colour	Grey	Black

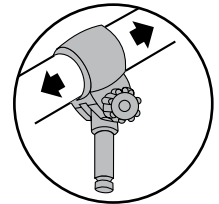
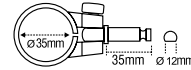

**Rowlock Socket for Inflatable Boat - Grey**

Code	57333
------	-------



**new**

**Rowlock Socket with Metal Pin, Grey**

Code | 74447



**Double Hook, Plastic with Thread, Ø30mm, Black**

Code	44243
------	-------



**Hook, Ø25mm, Black**

Code	50180
------	-------



**Female Hook with Double End, Plastic**

Code	Int. Ø (mm)	Colour
44249	25	Black
44246	30	

**Oar Collar, Plastic**

Made of heavy duty flexible PVC. For easier fitting, submerge the collar in soapy water.



Code	Diameter (mm)
16543	32
16544	36
16545	45

**Oar Collar, Plastic**



Code	Diameter (mm)	Height (mm)
44175	35	45
44176	40	45
44177	45	55
44178	50	55
44180	55	63

**Plastic Support Clip, Screwed**



Code	Diameter (mm)	Colour
45191	15	White
45192		Black
45197	20	White
45198		Black
45203	25	White
45204		Black
45209	30	White
45210		Black

Code	Diameter (mm)	Colour
45215	35	White
45216		Black
45235	40	White
45236		Black
45241	45	White
45242		Black

**Plastic Support Clip**



Code	Diameter (mm)
16702	16
16705	19
16703	25
16704	30
16707	50



Oarlock Polyamide

Code	A (mm)	Ø B (mm)	C (mm)	Ø D (mm)	Colour
44681	40	53	55	17	Black
44682	40	57			
197207	40	53			White
197208	40	57			

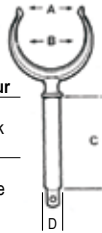

44681  
44682  
197207  
197208

Oarlock Socket

Code	Description	Colour
43588	Top-mount	Black
43587	Side-mount	
197210	Top-mount	White
197209	Side-mount	



Rowlock with Holder,  
Inox 316,  
Ø16mm, L.: 180mm

Code | 70632

Inflation Pumps & Accessories



new

Electric Double Action Air Pump

- Lightweight & comfortable grip
- Quiet operation
- Suitable for inflatable boats, air mattresses, pool floats etc.
- Ability of inflation & deflation

Code	198136
Input	100-240 V AC 50/60 Hz or DC 12 V
Output	400 lt/min
Maximum pressure	40 mbar (0,55 psi)
Function	Inflate / Deflate



Equipped with 3 size nozzles



Ability to connect to a cigarette lighter plug (1.25 m cable)



Comes with European charger



Electric Boat Inflator, 12V, 300 mbar, 450 lt/min

- Adjustable pressure up to 300 mbar / 4,4psi
- Low consumption: max 18A – 12V
- No need for special cable, a usual cigarette lighter is enough



Code | 90017

Pressure Regulator & Carrying Bag



new

Hand Pump, Double Action, High Pressure, with Manometer

- Easy-to-use, high-output hand pump
- Allows you to inflate all kinds of inflatable products faster and with less effort than any other pump in the market, thanks to its unique design
- The double action minimizes the inflation time in half
- It features an ergonomic handle, an enlarged base for maximum stability, a built-in pressure gauge and a protective filter
- The inflation port on the pump's body allows the hose to remain stable during use

Capacity: 2 x 1500 cc  
Max pressure: 1,9 bar (27.5 psi)  
Inflate mode: Double or single action  
Inflate-deflate: Inflate only  
Dimensions: 14 x 30 x 57 mm  
Construction: ABS + Aluminium  
Suitable for kite, sup, boats, kayaks, all inflatables



Inflation fittings are available for most common valves in the market



Kite-leash included



Code | 74622



Footpump

Code	11498	50952
Liters	3	5

Foot Pump with Double Chamber

With this foot pump, the inflation to the recommended pressure of all fabric or rubberized boats, can easily be achieved with very limited effort.



Code	90004
Liters	5,5

## Inflation Pumps & Accessories

Easy disassembly for inspection or maintenance



Adjustable pressure release valve



Made of lightweight, non-corrosive plastic

Foot rest

Comes with large, non-link hose and 4 sizes of interchangeable connecting nozzles and a multi-valve adaptor



### Double Action Hand/Floor Pump

The Double Action Hand/Floor Pump is practical and highly effective, ideal for inflating or deflating dinghies, ski tubes, air mattresses, plus many more inflatable products. To inflate or deflate simply fasten the air tube to the appropriate connection ("Inflate" or "Deflate") and pump with steady up and down strokes. The pump also features an adjustable pressure release valve that allows you to inflate, either easily on the down stroke only (2,1Lt per stroke) or faster on both the up & down stroke (4,2Lt per stroke). It is supplied complete with a flexible air tube with 4 sizes of adaptor nozzles and a kit of 6 adaptors (also sold separately). Large comfortable handles give better grip and foot plates provide stability during pumping. Made of strong, non-corrosive, lightweight, plastic for longer life, and with easy maintenance. It comes in grey colour.

- Ideal for use with large inflatables boats
- Continuous stream - pumps air on both the up and down stroke
- Simple push-in hose-to-pump connection to inflate or deflates
- Disassembles easily for inspection or maintenance

Code | 10230



#### Multi-Valve Adaptor

Code | 10231



#### Key for Valves

Code | 98789



#### Inflating Adaptor for Valve

Code | 98970



#### Gauge Meter

Code | 90090

## Deck Fillers



**new**

### INOX Deck Filler Ø38mm

Nuova Rade Inox Deck Fillers with Cap are suitable for fuel, fresh water or waste. The use is easily indicated by the colour of the cap: blue for fresh water, red for fuel and brown for waste. The main body is made of reinforced PA. The cap is made of Inox 316 and reinforced PA for endurance and extra durability in the marine environment. The cap features a lanyard in order not to be lost or fall into the water. These deck fillers have a tight fitting, as they can be secured with the use of a winch handle.



Code	Model	Diameter (mm)
198158	Water	38
198159	Fuel	
198160	Waste Water	

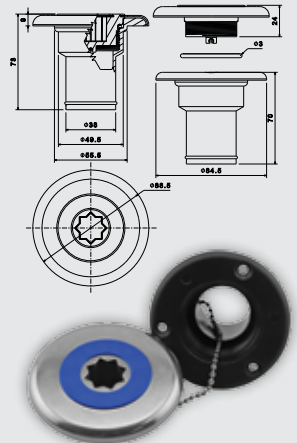

### Deck Filler Ø38mm Inox, with Vent 16mm

Deck Filler with vent is made of Inox. Depending on the use, you can choose the Deck Filler either for gas or water. The indication of use is shown at the top of the Deck Filler. It combines stylish design and complete sturdiness, and it is designed to fit easily on the deck. Nuova Rade Deck Fillers are available in Ø38 mm with a vent of Ø16 mm.

Code	74326	74327
For use	Gas	Water





Deck Fillers for Gas, Diesel, Water & Waste

The Deck Filler range includes deck fillers suitable for water, fuel and waste. They are designed in such a way that the full lid area is totally covered, which makes the final look much more attractive. Each deck filler can have a different function, which will always be clear - by using the relevant sticker (water, fuel, waste) included in each filler's packaging. They are made of highly resistant plastic and in 38mm and 50mm diameter. Available option with a chrome plated cap.

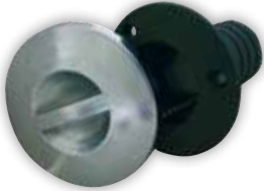

Deck Filler with Chrome Plated Cap

Code	70594	70595
Tube Diam.	38mm (1-1/2")	50mm(2")



Deck Filler with Cap

Code	99567	99568
Tube Diam.	38mm (1-1/2")	50mm(2")

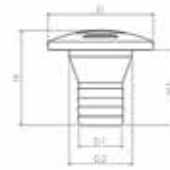

38 (1-1/2")



50 (2")

Hose diam. D1 (mm/inch)	H (mm)	H1 (mm)	diam. D (mm)	Cut out D2 (mm)
38 (1-1/2")	84	66	92	55
50 (2")				

Deck Filler, Glass Reinforced PA

Construction in 2 materials to combine sturdiness, lightweight and stylish design:

- Deck filler's body in glass reinforced nylon
- Cap in 316 L Inox
- Open with dual imprint key or manually thanks to finger-grip cap; the type of the liquid included (fuel, diesel, water) is written on the cap



Code	Model	Hose diam. (mm/inch)	H (mm)	H1 (mm)	H2 (mm)	Diam. D (mm)	Diam. D1 (mm)	Diam. D2 (mm)
197206	Water	38 / 1 1/2"	75	62	23	92	50	38
197203	Fuel	51 / 2"			-			-
197205	Diesel				-			-

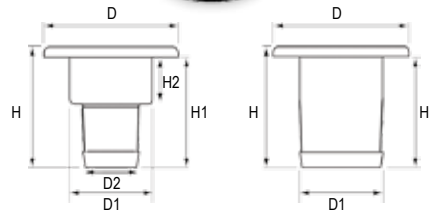

Plastic Deck Filler, Flip Top

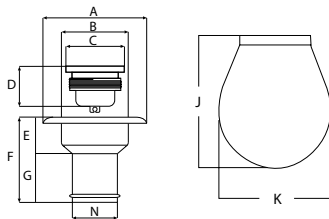

Code	Model	Hose Ø (mm)
196275	Water	38 (1½")
196265	Fuel	38 (1½")
196266		51 (2")
196267	Diesel	38 (1½")
196268		51 (2")

	A (mm)	Ø B (mm)	Ø C (mm)	D (mm)	E (mm)	F (mm)	G (mm)	Ø N (mm)	K (mm)	J (mm)
Ø 38	80x93	55	48	33	26	72	46	38	84	98
Ø 51	80x93	55	48	33	26	72	46	51	84	98



Plastic Deck Filler

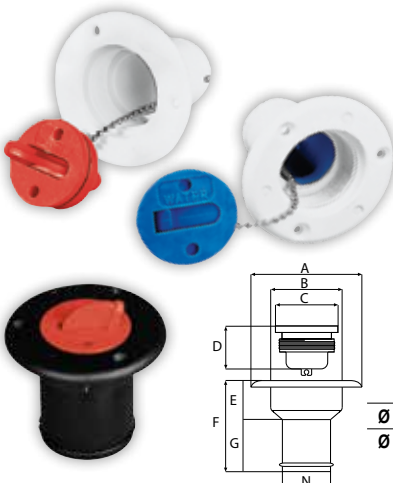

Code	Model	Hose Ø (mm)	Colour
45298	Water	38 (1½")	White
47618			Cream
45299			Black
35011	Fuel	38 (1½")	White
50311			Cream
45282			White
45283			Black

	A (mm)	Ø B (mm)	Ø C (mm)	D (mm)	E (mm)	F (mm)	G (mm)	Ø N (mm)
Ø 38	85	55	48	33	26	72	46	38
Ø 51	85	55	48	33	26	72	46	51

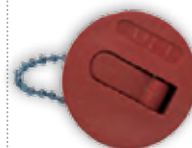

Spare Deck Filler Cap with Chain for Fuel

Code | 195015



Spare Deck Filler Cap with Chain for Water

Code | 195016

## Deck Fillers



### Case with Deck Filler

Made of plastic material.

Code	Use	Hose Ø (mm)	Colour
44306	Water	38	White
50023	Fuel		
50025	Diesel		
50024	Fuel	38	Cream

A (mm)	B (mm)	C (mm)	D (mm)	G (mm)	H (mm)	I (mm)
145	191	110	155	80	115	155

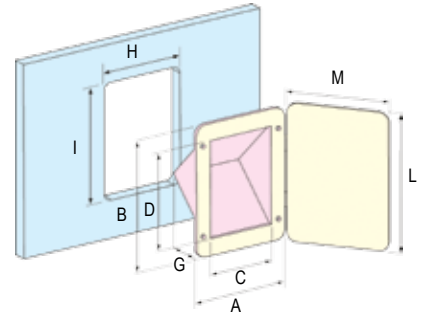

### Cases with Deck Filler and Lid

The body is made of PA and the lid is made of ASA.

Code	Use	Hose Ø (mm)	Colour
196419	Water	38	White
196417	Fuel		
196418	Diesel		
196415	Fuel	50	

A (mm)	B (mm)	C (mm)	D (mm)	G (mm)	H (mm)	I (mm)	L (mm)	M (mm)
145	191	110	155	80	115	155	200	165

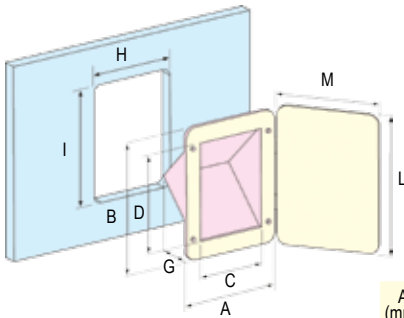

A (mm)	B (mm)	C (mm)	D (mm)	G (mm)	H (mm)	I (mm)
145	191	110	155	80	115	155

### Cases for Deck Filler

Made of PA material.

Code	Colour
44302	White
647442	Cream



### Cases for Deck Filler with Lid

The body of the product is made of PA and the lid is made of ASA.

Code	Colour
196414	White



## Roll Bars



### Roll Bar for Inflatable Boats, Inox 316

Height: 1120mm  
Diameter: 40mm  
Width: 1560-2060mm

Code | 70635

### Roll Bars

Made of very strong 40mm polished Inox 316 tubes. They feature a telescopic adjustment in width. The product code 70635 has welded Inox pads on the sights for navigation lights or antennas mounting.



### Roll Bar for Fibreglass Boats, Inox 316

Height: 1160mm  
Diameter: 40mm  
Width: 1650-2150mm

Code | 70636



HIDEA is a leading manufacturer of high-quality outboard motors, ranging from 2.5 to 60 HP 4- stroke engines, providing sea enthusiasts with new ways of easily exploring the water horizons.

Either for fishing adventures, daily cruises, water sports or just for relaxing, HIDEA offers various outboard engines to cover diverse lifestyle needs. In addition, choices vary according to control system (tiller or remote control), starting system (manual or electric with the revolutionary internal battery), fuel supply system (carbureted or EFI-Electronic Fuel Injection), shaft (short or long), and many more. With quiet operation and high corrosion resistance, HIDEA engines are the ideal solution for your summer excursions, even in the most demanding conditions.



**HIDEA motors come with warranty:  
3 years for leisure use & 1 year for professional use.**

**Full service & after sales support in  
Greece, Cyprus, Croatia, Montenegro, Slovenia, Serbia, Bosnia-Herzegovina, Albania, North Macedonia, South Africa.**

**LIGHTWEIGHT & PORTABLE**

HIDEA 2.5 HP, 5 HP and 6 HP outboard engines are lightweight and portable. They are a reliable solution to transport either people in your tender or goods over short distances, and also enjoy a fishing day with your friends and family. HIDEA portable series is designed to be simple, elegant and lightweight but also built to last. With a built-in tank (0.9L, 1.1L), these engines give you the ability for extra miles. Variety of options: short or long shaft, optional addition of an external fuel tank.

**2.5 HP - 5 HP - 6 HP**



Model	2.5HP		5HP		6HP	
	HDF2.5HS	HDF5HS	HDF5HL	HDF6HS	HDF6HL	
Code	73689	73690	73691	73692	73693	
Cylinder(s)	1	1		1		
Max.output (KW)	1.8	3.6		4.4		
Shaft	Short	Short	Long	Short	Long	
Displacement (cc)	72	112		139		
Weight (kg)	17	22	23	27	28	
Gear Ratio	27:13(2.08)					
Gear Shift Position	F-N	F-N-R		F-N-R		
Starting System	Manual	Manual		Manual		
Control System	Tiller	Tiller		Tiller		
Fuel Capacity (L)	0.9 (built-in fuel tank)	1.1 (built-in fuel tank)		1.1 (built-in fuel tank) & 12 (external fuel tank, included in the package)		



## ULTIMATE EFFICIENCY

HIDEA 9.9 HP, 15 HP and 20 HP outboard engines have a revolutionary design being the only ones in the world also available with internal battery for electric start. An ideal and reliable choice for mid-size tenders, RIBs or fishing boats that travel near to the coast. Very popular among fishermen, having just the power they need. Several options to choose from, including short or long shaft, manual or electric start (optional with internal battery) and tiller or remote control.

### 9.9 HP - 15 HP - 20 HP

Model	9.9HP				
	HDF9.9HS	HDF9.9HL	HDF9.9HES-IB	HDF9.9HEL-IB	HDF9.9FEL
Code	73694	73695	73705	73696	42559*
Cylinder(s)	2				
Max.output (KW)	7.2				
Shaft	Short	Long	Short	Long	Long
Displacement(cc)	212				
Weight (kg)	41.6	43	41.6	43	43
Gear Ratio	27:13(2.08)				
Gear Shift Position	F-N-R				
Starting System	Manual		Manual & Electric w/internal battery		Manual & Electric
Control System	Tiller				Remote control
Fuel Capacity (L)	12 (external fuel tank, included in the package)				

Model	15HP				
	HDF15HS	HDF15HL	HDF15HES-IB	HDF15HEL-IB	HDF15FEL
Code	73697	73698	73706	73699	42560*
Cylinder(s)	2				
Max.output (KW)	11				
Shaft	Short	Long	Short	Long	Long
Displacement(cc)	323				
Weight (kg)	53.4	54.4	53.4	54.4	54.4
Gear Ratio	27:13(2.08)				
Gear Shift Position	F-N-R				
Starting System	Manual		Manual & Electric w/internal battery		Manual & Electric
Control System	Tiller				Remote control
Fuel Capacity (L)	12 (external fuel tank, included in the package)				

Model	20HP					
	HDEF20HES	HDF20HEL	HDEF20FES	HDF20FEL	HDF20HS	HDF20HL
Code	73707	73700	73708*	73701*	74521	74522
Cylinder(s)	2					
Max.output (KW)	14.7					
Shaft	Short	Long	Short	Long	Short	Long
Displacement(cc)	323					
Weight (kg)	53.4	54.4	53.4	54.4	53.4	54.4
Gear Ratio	27:13(2.08)					
Gear Shift Position	F-N-R					
Starting System	Electric	Manual & Electric	Electric	Manual & Electric	Manual	
Control System	Tiller		Remote control		Tiller	
Fuel Capacity (L)	12 (external fuel tank, included in the package)					

\*With remote control box, steering wheel, steering mechanism, steering cable (3.3m) & engine control cable (throttle/gear) (2x3.3m) & tool bag with some spare parts (fuses, spark plug, impeller etc.).



Combine with Hidea oil page 136

Boats, Engines & Accessories



Combine with  
Hidea oil  
page 136



## RELIABILITY & PERFORMANCE

HIDEA 30 HP and 40 HP outboard engines (2 & 3 cylinders respectively) come with the unique EFI (Electronic Fuel Injection) technology. The EFI system is more efficient with drastically lower fuel consumption. Additionally, the power output of these engines is more linear than the carbureted ones. Due to their weight and power ratio, they are considered as compact "kings", strong and reliable. They come as standard with remote control, electric start, trim & tilt system, short or long shaft. They also come with water/fuel filter separator (applies only for 40HP), engine control cables (throttle/gear) (2x5.5m) and tool bag with some spare parts (fuses, spark plug, impeller, etc.). Ideal choice for many different uses, for boats 4-6 meters. High efficiency, low noise levels and low consumption are only some of the main advantages of these outboard engines.

- 30 HP – *Optional: instruments (tachometer)*

- 40 HP – *Standard with analog/digital instrument (RPM, speedometer, w/ battery charging & working hours data)*

### 30 HP - 40 HP

Model	30HP		40HP
	HDEF30FES-T	HDEF30FEL-T	HDEF40FEL-T
Code	73709	73702	73703
Cylinder(s)	2		3
Max.output (kW)	22		29.4
Shaft	Short	Long	Long
Displacement(cc)	498		747
Weight	78	80	97
Gear Ratio	27:13(2.08)		26:13(2.0)
Gear Shift Position	F-N-R		
Starting System	Electric		
Control System	Remote Control		
Fuel Capacity (L)	24 (external fuel tank, included in the package)		
Power Trim	✓	✓	✓

**HIDEA 30 HP advanced outboard engine is also available (code: 74287).**

## THE ULTIMATE "ALL AROUND" OUTBOARD ENGINE

The biggest outboard EFI engine by HIDEA is the 60 HP one, and is considered to be the perfect "all-rounder". Whether you want to enjoy watersport activities, travel to far distance islands or just try your luck at fishing, HIDEA 60 HP quiet and stable 4 cylinder EFI engine, offers ultimate efficiency and increased fuel economy. With displacement of 996 cc it provides an adequate amount of power for almost everyone riding a medium to bigger power inflatable or FRP boat. A very reliable choice for recreational or semiprofessional use. Comes as standard with remote control, electric start, trim & tilt system, analog/digital instrument (RPM, speedometer, w/ battery charging & working hours data). It also comes with water/fuel filter separator, engine control cables (throttle/gear) (2x5.5m) and tool bag with some spare parts (fuses, spark plug, impeller, etc.).

### 60 HP

Model	60HP HDEF60FEL-T
Code	73704
Cylinder(s)	4
Max.output (kW)	44.1
Shaft	Long
Displacement(cc)	996
Weight	124
Gear Ratio	24:13
Gear Shift Position	F-N-R
Starting System	Electric
Control System	Remote control
Fuel Capacity (L)	24 (external fuel tank, included in the package)
Power Trim	✓

## Propellers

new

### Propellers

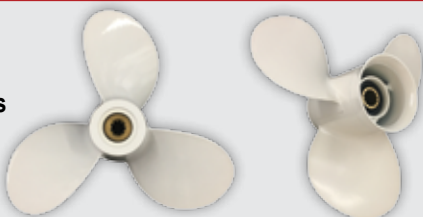

Code	Model	For outboard engine
73858	7 1/2 x 7 BA	Hidea/Yamaha 4/5 HP
73921	7 1/2 x 8 BA	Hidea/Yamaha 6 HP
73813	7 1/4 x 6 BS	Hidea/Yamaha 2.5 HP
74270	8 1/2 x 7 1/2 N	Yamaha 6-8 HP
73977	8 1/2 x 8 1/2 N	Hidea/Yamaha 8/9.9 HP
74272	9 1/4 x 10 J1	Yamaha 9.9-15 HP
74028	9 1/4 x 11 J1	Hidea/Yamaha 15/20 HP
74271	9 1/4 x 9 3/4 J	Yamaha 9.9-15 HP
74273	9 7/8 x 11 1/4 F	Yamaha 25-30 HP
74101	9 7/8 x 12 F	Hidea/Yamaha 30 HP
74274	9 7/8 x 13 F	Yamaha 25-30 HP
74156	11 1/8 x 13 G	Hidea/Yamaha 40 HP
74276	11 3/8 x 12 G	Yamaha 40-60 HP
74275	11 5/8 x 11 G	Yamaha 40-60 HP
74277	13 1/2 x 15 K	Yamaha 60-140 HP
74278	13 1/4 x 17 K	Yamaha 60-140 HP
74282	13 3/4 x 21 M	Yamaha 150-300 HP
74222	13 5/8 x 13 K	Hidea/Yamaha 60 HP
74279	13 x 19 K	Yamaha 60-140 HP
74280	14 1/2 x 17 M	Yamaha 150-300 HP
74281	14 x 19 M	Yamaha 150-300 HP

new

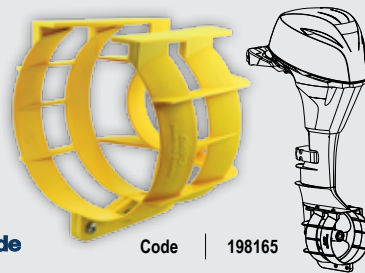

Nuova Rade

Code | 198165

### Propeller Guard, Plastic, Ø23cm, Yellow

Nuova Rade Propeller Guard is a smart consideration and safeguard for your outboard. The installation will greatly reduce the possibility of human and marine life injuries due to the propeller blades and will also protect the propeller from nets and ropes. You will not have to worry about propeller maintenance and safety anymore.

Additionally, a propeller guard can reduce fuel consumption, so that you save on gas and, at the same time, it improves handling and stability, for a more enjoyable time on your boat. This is because the guard is made to surround the propeller in such a way that it moves the water with a more accurately directed force. Finally, the guard does not contain moving parts, so its maintenance is minimal. Having fast & easy installation, it enhances safety on board.

Made of reinforced polypropylene.

Compatible with most 9-25 HP engines with max. propeller Ø21.6cm. It is ideal for rescue boats and yachts that might sail on waters with many bathers. Note that the necessary bolts, nuts & washers are included in the package.

## Outboard Engine Accessories

new

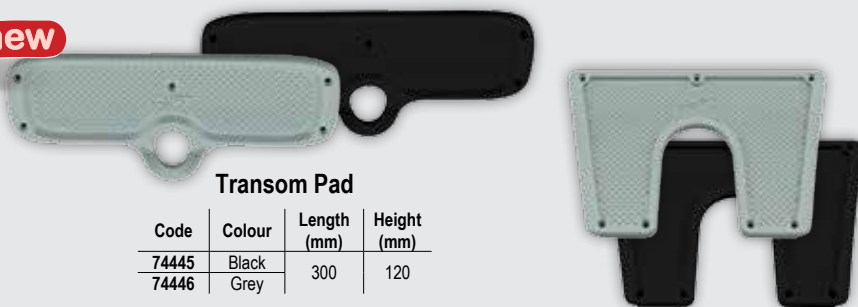

### Transom Pad

Code	Colour	Length (mm)	Height (mm)
74445	Black	300	120
74446	Grey		

### Transom Pad

Code	Colour	Length (mm)	Height (mm)
74443	Black	270	180
74444	Grey		



### Transom Pad

Code	Colour	Length (mm)	Height (mm)	Thickness (mm)
45343	Black	230	86	7
45341	White			
45342	Grey			
45339	Black	270	98	8
45337	White			
45338	Grey			



### Transom Pad

Code	Colour	Length (mm)	Height (mm)	Thickness (mm)
45331	Black	300	220	7
45329	White			
45330	Grey			
45335	Black	450	360	
45333	White			
45334	Grey			



### Transom Pad Reinforced

Rigid non-slip plastic. Prevents outboard clamps from damaging the transom.

Dimensions: 250 x 90 mm, Thickness: 10mm

Code | 16943



**Transom Pad Tilted**

Code	Colour	Length (mm)	Height (mm)	Thickness (mm)
195139	Black	450	360	5-19
195136	White			
195138	Grey			



**Transom Pad with Cleft**

Code	Colour	Length (mm)	Height (mm)	Thickness (mm)
45327	Black	450	360	6,5
45324	White			
45326	Grey			



**Transom Pad**

It offers protection against outboard clamp damage for most sizes of transoms. This pad is made of rigid UV stabilized polypropylene, with a non-slip surface for secure engine mounting.

Code	10314	72032	72033
Colour	White	Grey	Black
Dimensions (mm)	320 x 220		
Thickness (mm)	6,4		



**Engine Cover**

SEA COVER Engine Covers are ideal for the protection against water, sun and dust. They are made of extra strong polyester 420D, 0,15mm thick for maximum water resistance and UV protection. They are suitable for most types of outboard engines, from 2 to 300hp and are available in two different types. There are the covers suitable only for the top part of the engine (not the shaft) and feature an elastic cord all around for ideal fit to most types of outboard engines.

Additionally, there are the full body covers, which feature an elastic cord and a zipper, so as to ensure the best possible engine's protection, including its shaft. You can find 7 different sizes of the covers for the top part of the engine and 3 different sizes for the full body covers. All come in silver colour. The tables below show the different sizes of the covers. The dimensions refer to the length, the width and the height of the cover (Drawing 1). The horsepower given is approximate and it is not the only factor that should be taken into consideration when choosing your cover. The type of the engine (2 stroke, 4 stroke), the length of the throttle grip, the brand of your motor and its production date should also affect your choice, as they differentiate the size of the engine.



**Cover for the Top Part of the Engine**

Code	57269	57270	57271	57272	57273	57274	57275
H.P (Approximate)	2-5	2-15	10-45	30-90	70-150	115-225	150-300
A (cm)	40	46	55	63	73	75	90
B (cm)	25	27	33	35	40	45	60
C (cm)	32	35	45	50	65	75	80

**Full Body Engine Cover**

Code	57329	57330	57331
H.P (Approximate)	2,5-10	8-70	70-150
A (cm)	75	87	125
B (cm)	125	157	210



To choose the most suitable cover for the top part of your engine, measure it as shown in the Drawing 2 and determine the dimensions that more closely match your model.

To choose the most suitable full-body cover for your engine, you should measure the engine's height (B) as well as its width (W). In order to calculate

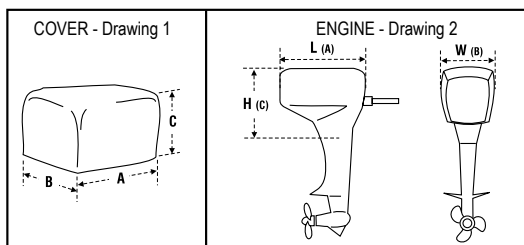

\*When calculating the height of the engine you should also include a part of the shaft, as shown in Drawing 2, in order to ensure that the engine will be covered completely underneath (apart from the shaft).

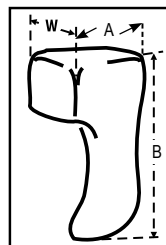

correctly the maximum height that the appropriate cover should have, you should deduct from the engine's height (B) half of its width (W). For instance, if the height (B) of your engine is 210cm and its width (W) is 50cm, then the cover that you need should be 185cm (210cm-25cm) high. Therefore, in this case, the correct cover is cover 57331, which is 210cm high, as indicated in the relevant table.



# Outboard Engine Accessories



## Tiller Extension for Outboard Engine

Code	Length
27117	65cm
27118	100cm
27119	80-111cm Telescopic



Boats, Engines & Accessories



## Engine Starter Rope, Polyester

Code	90252	90253	98069
Diameter (mm)	3	4	5
Breaking Load (kg)	240	370	500

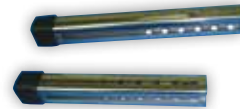

## Safety Lock for Outboard Engines, Inox 316

Code	99525	99526
Length (mm)	235	280



Code | 90726

**Outboard Bracket, Adjustable, with Plastic Pad, Inox 316, for Engines up to 40kg/20HP**

5-position adjustment control



Code | 90725

**Outboard Bracket, Adjustable, with Plastic Pad, Inox 316, for Engines up to 30kg/15HP**

5-position adjustment control



Code | 99493

**Outboard Bracket, Adjustable, with Plastic Pad, Inox 316, for Engines up to 20kg/8HP**



Code | 95890

**Outboard Bracket, Adjustable, with Plywood Pad, Inox 316, for Engines up to 40kg/20HP**

5-position adjustment control



Code | 99492

**Outboard Bracket, Adjustable, with Wooden Pad, Inox 316, for Engines up to 20kg/8HP**



**Outboard Adjustable 0-17° Bracket, with Wooden Table, Inox, for Engines up to 10HP & Max. weight 30kg**

Code | 99494



**Outboard Adjustable 0-17° Bracket, with Wooden Table, Inox, for Engines up to 12HP & Max. weight 35kg**

Code | 99495





**Motor Bracket, Rail Mounted, White**

Ideal for permanently mounting your outboard on the stern rail instead of having to remove it when not in use. Made of rigid, non-slip UV resistant plastic, the bracket provides a secure and stable mount for your auxiliary outboard engine. Designed to fit 25mm diameter rails.



Code | 10319

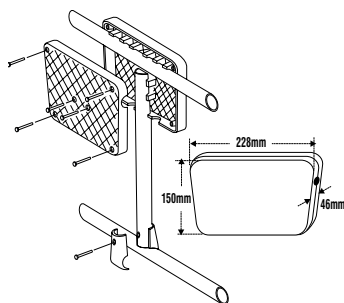

Boats, Engines & Accessories



**Outboard Engine Flusher, Double Intakes, Large**

Length 280mm / Diam. 16mm

Code | 47086



**Outboard Engine Flusher, Oval**

Code | 98749



**Outboard Engine Flusher, Rectangular**

Code | 98748



**LZ-Hydrofoil**

The LZ torque control system ensures the ultimate performance in precise and effortless steering.

- Features:**
- Lower fuel consumption
  - Straight tracking
  - Excellent steering at low speeds
  - Smoother ride
  - Maximum lift
  - Reduced planing time
  - Increased stability
  - Reduced cavitation
  - Effortless installation
  - Inox bolts included

- Secure mounting with bolts
- For use on outboard motors



Code	10121	10122
For Engines	4HP to 50HP	50HP and over
A(mm)	185	270
B(mm)	180	240
C(mm)	5	7
D(mm)	23	30
E (mm)	61	98

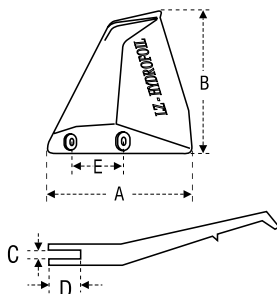

**Motor Trolley (30hp), Knock Down, 25mm Tubing**



Code | 99586

Total Height: 1000mm  
Total Weight: 800mm

Available only in certain countries

**new**



**HIDEA**

**Hidea oil 4 cycle, FC-W 10W30 1 lit.**

Code | 74283



**CLIN AZUR**

**511**  
PTFE lubricant  
200ml



**CLIN AZUR**

**550**  
Silicon lubricant  
200ml

Boats, Engines & Accessories



**Outboard Gear Oil Ep 90**

Enhanced gear-oil for gearboxes and outboard engines' gear. Reduces friction, damage, and corrosion from salt.

Code | 71130  
Package | 250ml



**Outboard Grease**

A special type of grease, specifically made for marine applications. Indicated for protection from operational friction, and salt corrosion.

Code | 71136  
Package | 250ml



**Fuel Water Remover**



A fuel-treatment that eliminates problems caused by the presence of water in fuel. Also, prevents the formation of water within the fuel. Suitable for gasoline or diesel fuel.

Code | 71134  
Package | 300ml

**Top Diesel Additive**



Multifunctional fuel-treatment product. Keeps diesel fuel injectors cleaner, increases cetane number, improves combustion and drastically reduces exhaust fumes. Additionally, it reduces fuel consumption and removes moisture.

Code | 71133  
Package | 1lt

**Green Power Plus Semi-Synthetic Oil for 2 Stroke Engines**



Semi-synthetic oil for 2 stroke engines with carburetor or injection system.

Code | 71128  
Package | 1lt

**Helms & Steering Systems**

**Bezel Kit, Applicable for 90°**



Code | 90775

**Light Type**

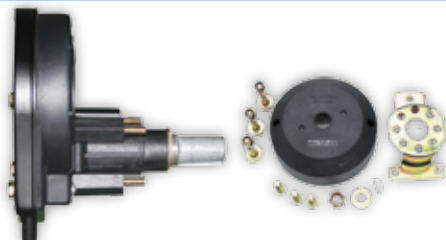

**Steering Helm, Light Type, for Engines up to 55HP**

- Applicable for boats with outboard engines up to 55hp
- Approximately 2.5 turns of steering wheels
- Maximum steering wheel diameter: 375mm
- Wear-resistant engineering plastic helm cover
- High pressure die cast zinc alloy shaft

Code | 90773



## Steering Cable for Helm Light Type

- Suitable for 90773 steering helm
- Spiral inner cable diameter: 6.2mm
- Maximum travel: 230mm
- Stainless steel output ends
- Cable outer diameter: 12.5mm
- Minimum bend radius: 200mm
- Maximum working load at tiller end: 120kg

Code	90777	90778	90779	90780	90781	90782	90783	90784	90785
Length(ft)	8	9	10	11	12	13	14	15	16
Code	90786	90787	90788	90789	90790	90791	90792	90793	90794
Length(ft)	17	18	19	20	22	24	26	28	30

## Heavy Duty Type



## Steering Helm, Heavy-duty Type, for Engines up to 150HP

- Applicable for 9m boat with outboard engine and for 10.5m with inboard engine
- Approximately 4 turns of steering wheels
- Maximum steering wheel diameter: 400mm
- High pressure die cast aluminium alloy helm cover
- Galvanised shaft
- Easy and quick installation

Code | 90774



## Steering Cable for Helm Heavy-duty Type

- Suitable for 90774 steering helm
- Spiral inner cable diameter: 8mm
- Maximum travel: 230mm
- Stainless steel output ends
- Cable outer diameter: 15mm
- Minimum bend radius: 200mm
- Maximum working load at tiller end: 500kg

Code	90795	90796	90797	90798	90799	90800	90801	90802	
Length(ft)	9	10	11	12	13	14	15	16	
Code	90803	90804	90805	90806	90807	90808	90809	90810	90811
Length(ft)	17	18	19	20	22	24	26	28	30

# Steering Wheels & Accessories



Steering Wheel "Sport",  
Ø 350mm

Code | 90039



Steering Wheel "Winner",  
Ø 350mm

Code | 90040



Steering Wheel "Ocean Master",  
Ø 350mm

Code | 90041



Adaptor for Steering  
Wheels

Code | 90042

## Steering Wheels & Accessories



**Steering Wheel, Inox,  
with Black Foam**

Code	99701	99702
Diameter(mm)	390	343



Ø19,3mm



**Steering Wheel, Inox,  
with Cap**

Code	90072	90087	90071
Diameter(mm)	343	390	457

### Steering Wheel "Classic", Ø 350mm

Steering wheel "Classic" is made of polypropylene with 350mm diameter, while the diameter of the wheel's hole is 37mm. It has an ergonomic design and will fit very simply into most boats. You have the choice to customise the logo label on the centre of the steering wheel, by adding the customised PVC sticker.

Code	70001	70132
Colour	Black	White



### Handle Bar for Steering Wheels, Inox



Code | 90177

## Cable Boots



**Cable Boot, Adjustable with Screwed Ring**

Code	Colour	Cut-out Ø	Overall Ø	Height
43756	Black	85 mm	105 mm	68 mm
43754	White			68 mm



**Cable Boot with Screwed Ring**

Code	Colour	Cut-out Ø	Overall Ø	Height
43168	Black	60 mm	108 mm	140 mm



**Nuova Rade**

**Cable Boot with Plastic,  
Embedded Ring**

Code	Colour	Cut-out Ø	Overall Ø	Height
43137	Black	59 mm	89 mm	105 mm

### Cable Boot, Flush mounted



Code	Colour	Cut-out Ø	Overall Ø	Height
43167	Black	76 mm	115 mm	140 mm
43165	White			
43166	Grey			

### Cable Boot, Flush mounted



Code	Colour	Cut-out Ø	Overall Ø	Height
31521	Black	69 mm	103 mm	109 mm
43162	White			
43163	Grey			



### Cable Boot, Flush mounted

Code	Colour	Cut-out Ø	Overall Ø	Height
43160	Black	50 mm	70 mm	60 mm
43159	Grey			
43158	White			

## Cable Boots



**Cable Boot, Splitted with Screwed Ring**

Code	Colour	Cut-out Ø	Overall Ø	Height
43155	Black	105 mm	115 mm	52 mm



**Cable Boot, Double with Screwed Ring**

Code	Colour	Cut-out Ø	Overall Ø	Height
43133	Black	59 mm	89 mm	15 mm



**Cable Boot with Screwed Ring**

Code	Colour	Cut-out Ø	Overall Ø	Height
31523	Black	120 mm	150 mm	110 mm
43145	White			
31525	Black	55 mm	105 mm	65 mm
43139	White			

## Engine Controls & Accessories

**new**



**Control Lever V-20S, Side mounted with Trim-tilt**

Code | 74635



**Single Control, Side mounted, Brass**

Code | 99803



**7 Kill Switch Keys, Set**

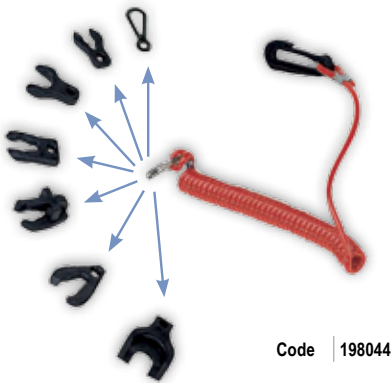

Code | 198044

**Kill Switch Key with Coil Lanyard, Set**

Code	For Motors
28137	Mariner/ Mercury
28138	Mariner/ Suzuki / Johnson (4 strokes)
28139	Tohatsu
28140	Honda / OMC
43693	OMC / Johnson - Evinrude
28141	Yamaha
35003	OMC

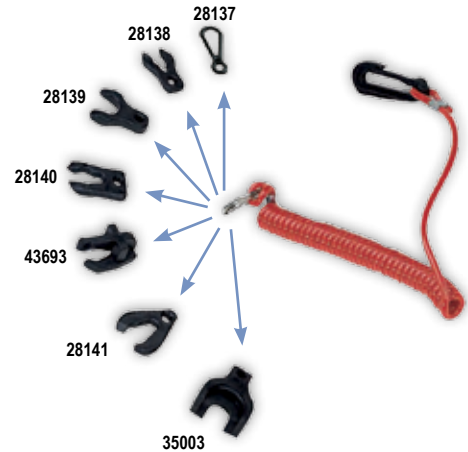

**Kill Switch, 12V, 15A**

Code	Description
99974	With Coil Lanyard



**Ignition Starter Switch, 3 Positions**

Code | 99116



**Ignition Switch, Nickel-plated Brass, 3 Positions**

Code | 99557



**Switch Ignition Starter OFF-IGN-START-CHOKE**

Code | 99687



**Switch Ignition Starter**

Code	Contacts	Description	Terminals	Max Diam. Panel
99691	3	OFF-IGN-START(CHOKE)	6	6,35mm
99692	3	OFF-IGN-START(CHOKE)	6	15,8mm
99686	4	ACC-OFF-IGN-START	7	15,8mm
99690	4	ACC-OFF-IGN-START	7	6,35mm

## Engine Controls & Accessories



**Keychain Buoy**

Code	72448	72541
Color	Red	White



**Keychain Fender**

Code	72540	72447
Color	Red	White



**Key-Ring Floating**

Code | 44526



**Key Holder-Cork, Floating, Round**

Code | 71963

## Engines Control Cables



**Universal - Standard Cable for Inboards & Outboards, 10-32 UNF Thread**

Code	70091	70092	70093	70094	70095	70096	70097	70098	70099
Length(ft)	6	8	10	12	14	16	18	20	22

## Impellers

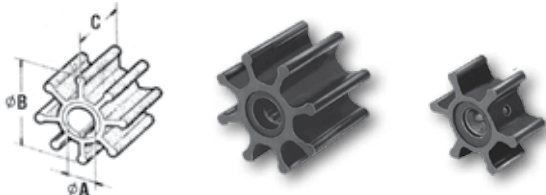

For **Evinrude - Johnson** engines

Code	Manufacturer Code	Engine Specifications	Dimensions (mm)		
			A	B	C
99265	377230	35HP w/Thermostat (1958-1959), 40HP (1960-1970), 50HP (1971-1975), 55HP (1971-1978)	16,04	69,8	22,1
99268	386084	8, 9.9, 15HP(4 strokes), 9.9HP(4 strokes), 15HP (1974-1980), 15HP (1981-1989), 15HP (1990->)	12,75	38,4	17,9
99269	388702	25HP (old model)	16	51,5	19,05
99177	395289	20HP (1978-84), 20HP (1985-2002), 25HP (1978-84), 25HP (1985-2002), 25HP comm. (1998-02), 25, 35 (3cyl) (1995-2002), 28, 14 COMM. (1985-97), 30HP (1985-97), 30, 35 (2cyl) (1983->), 30, 35 (1980-82), 35 (1976-77), 35 (1976-77), 35HP (1980-97)	16	51	19



For **Honda** engines

Code	Manufacturer Code	Engine Specifications	Dimensions (mm)		
			A	B	C
99277	19210-881-003, 19210-881-A01	5HP M-X series later version, 5HP earlier version, 5HP BF50 (F), 5HP BF5A (H-K), 7.5HP BF75 (A-B-C-D-E-F), 8HP (AH-AK), 8HP (AM-AX-B-BX), 10HP BF100 (A-B-C-D-E-F)	14,2	41	23
99278	19210-ZW1-B02	75HP (AV-AX 1999>), 90hp (AV-AX 1999>), 115hp (1999>), 130hp (1999>)	23,35	87,8	31
99279	19210-ZV5-003	35HP (AM), 40HP (A-AX-B-BX), 45HP (AM), 50HP (A-AX)	17,2	55,75	20,2
99283	19210-ZW9-A31	8/10HP (2000)	16,2	45,6	14,8
97910	19210-ZW1-003, 19210-ZW1-303	75HP (AT), 90HP (AT)	22,4	89	32,5

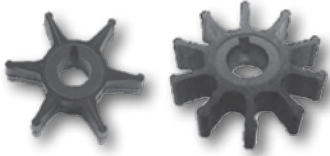
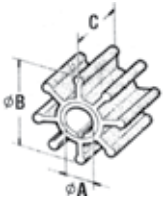

For **Chrysler-Force** engines

Code	Manufacturer Code	Engine Specifications	Dimensions (mm)		
			A	B	C
97914	47-E69406, 47-803631	90/120HP - F5 150HP - 5Cyl (88 >)	22,2	60	33,8

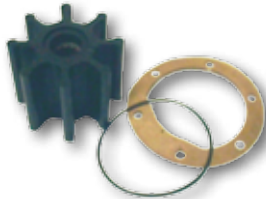
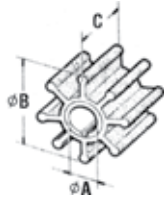

For **Sole** engines

Code	Manufacturer Code	Engine Specifications	Dimensions (mm)		
			A	B	C
99296	312.11.008	mini - 11-14-17-23-26-29-32-33-34-44-48	12	52	25
97897	351.11.008	mini - 50-55	14,4	57	31,6
97885	347.11.008	SM75, SM90, SM105, mini - 62-74, SN85, 150HP	14,2	65	50,2

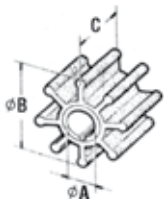

For **Mercury** engines

Code	Manufacturer Code	Engine Specifications	Dimensions (mm)		
			A	B	C
97907	47-16154	4/5/6HP (4 strokes)	10,25	33,6	14,3
97908	47-20268, 47-65959, 47-89983	30HP (1217222-1448139), 35HP (1571114-1812753), 35HP (6445653-B110788), 40HP (1279685-1476509), 40HP (2874704-3336257), 40HP (4362215-4860102), 40HP (4862103-6445652), 45HP (1476510-1520983), 45HP (1520984-1531568), 45HP (5531630 >), 50HP (1421113-1639472), 50HP (1521914-2305100), 50HP (2305101-2858813), 50HP (4357640-4962055), 50HP (4962056 >), 60HP (6428681 >), 65HP (2803562-3293183), 70HP (4571652-4977156), 70HP (4977157-6428680), MK35A (all)	19	51,8	19,05
97910	47-43026-T2	70HP (A996142 >), 70HP (B240451 >), 75HP (C222000-D283221), 75-90HP 4T, 80HP (A996142 >), 80HP (B240451 >), 90HP (A996142 >), 90HP (B240451 >), 90HP (C222000-D283221), 100HP (B209468-D283221), 115HP (C100000-D283221)	22,4	89	32,5
97914	47-65960, 47-89984	2.4EFI HP (all), 65HP (1542745-2309310), 65H (2309311-2803561), 70HP (1413611-1566239), 75H (4cyl.) (6432901 >), 80HP (1335465-1398629), 80HP (1398630-1566239), 80HP (2559001-3493912), 80HP (4831999-6432900), 85EL HP (4590512-4831998), 85HP (1460999-1766823), 85HP (3493913-4366801), 85XS HP (4366802-4831998), 90HP (1766824-1869775), 90HP (6cyl.) (4845301-5299505), 95HP (1869776-2318585), 100HP (1464949-1768403), 100HP (1768404-2318585), 100HP (2318586-2836108), 110HP (1870204-2314955), 115HP (2836019-3255440), 125HP (2314956-2839368), 125HP (2839369-3293233), 135HP (A904646 -), 140HP (3293234-3502805), 140HP (4865678-5327662), 150HP (3502806-4865677), 150HP (4868998-A904645), 150HP (A904646 -), 175HP (4301235-6618750), 175HP (6618751 -), 200HP (4839034-6625220), 200HP (6625221 -), 220HP (B117316 -), 225HP (5628028 -), mod. VP HP (all), XR/4 HP (B242885 -)	22,2	60	33,8
99285	47-19453T	40HP (4cyl.), 40HP EFI, 40HP JET, 45HP JET, 50HP (4cyl.), 50HP EFI, 55HP (3cyl.), 60HP (3cyl.), 60HP (4cyl.), 80HP EFI	19,25	78,2	25,15
99177	-	-	16	51	19

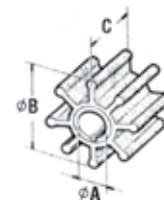

For **Suzuki** engines

Code	Manufacturer Code	Engine Specifications	Dimensions (mm)		
			A	B	C
99299	17461-93902	9.9/15 CV	13,2	42	22
97908	17461-95201	DT55 (1985-95), DT65 (1985-95)	19	51,8	19,05

Boats, Engines & Accessories

## Impellers

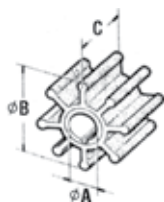

For **Yamaha** engines

Code	Manufacturer Code	Engine Specifications	Dimensions (mm)		
			A	B	C
99310	6G1-4452-00-00	6/8HP (1984-2002) (2strokes)	11,9	40	18
99313	63V 44352-01-00	9.9HP (1996-2004), 15HP (1996-2004), F15(1998-2002), T8 (2001-2002)	12,85	53	14
99318	6H4-44352-02-00	25HP (1999 >>), 30HP (1987-1995), 40HP (1984-1994), 50HP (1984-1994), 50HP jet (1986-1989), F25 (2000-2004), F30 (2001-2002), F40 (2000-2004), P50 (1991-1993), PRO50 (1987-1994), T25 (2001-2002)	16,1	51	19
97916	682-44352-01-00	8/9.9HP (1999 >>), 9.9HP (1984-1995), 15HP (1985), 15HP (1987-88), F9.9(1985-1990), T9.9 (1985-1996)	13	40	22
97920	6E0-44352-00-00	4HP (1985-1998), 4HP (1999 >>), 5HP (1984-2002)	11	40	12,6
99265	6F5-44352-00-00	C40 (1992-1997), CV40 (1990)	16,04	69,8	22,1

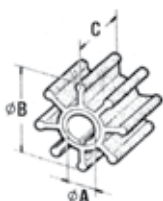

For **Tohatsu** engines

Code	Manufacturer Code	Engine Specifications	Dimensions (mm)		
			A	B	C
98576	3B2-65021-1	6-8-9,8HP (2 strokes)	12,12	40	18,03
98579	345-65021-0	25-30HP (2 strokes)	17,12	44,10	20,25
98580	334-65021-0	9,9-15-18HP (2 strokes), 15-18HP (4 strokes)	13,96	40,70	23,35
98581	3C7-65021-1, 3B7-65021-2	70-90HP (2 strokes), 120-140HP (2 strokes)	20,15	67,40	35,10
97907	369-65021-1	2.5HP (2 strokes), 3.5HP (2 strokes), 4-5HP (2 strokes), 4-5-6HP (4 strokes)	10,25	33,60	14,30

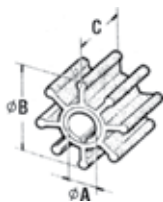

For **Renault** engines

Code	Manufacturer Code	Engine Specifications	Dimensions (mm)		
			A	B	C
99295	-	RC 16D (nitrile)	12,15	50,8	22,1
97883	-	RC 16D	9,54	39,6	18,94
97884	-	RC 210D	25	95	63,1
97885	-	RC 320D	14,2	65	50,2

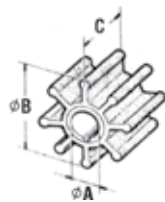

For **Yanmar** engines

Code	Manufacturer Code	Engine Specifications	Dimensions (mm)		
			A	B	C
99309	119574-42550	6LY2-STE, 6LYA-UTE/-STE	25	65,7	80
99295	104211-42070	2GM/GM20, 2QM/QM15/QM20, 3GM/GM30/QM30, SB12, SB8, SVE12, SVE8, YS B8/E8 - B12/E12, YSM8/YSM12	12,15	50,8	22,1
97883	104211-42070	2GM/GM20, 2QM/QM15/QM20, 3GM/GM30/QM30, SB12-SB8, SVE12-SVE8, YS B8/E8 - B12/E12, YSM8/YSM12	9,54	39,6	18,94
97885	127610-42200	4LHA-HT (Z) E, 4LH-DTE/-THE/-STE/-TE, 4PH-TE/PHE/PHME/PHM-TE, 6PH-THE/PH-TE/PHE/PHME, 6PHM-(H)TE, 6PHME, 6PH-TE	14,2	65	50,2
97897	129470-42530	3JH2E, 3JH2-TE, 4JH2E/4JH2-TE, 4JH2-UTE (B), 4JH-E/TE/HTE/DTE	14,4	57	31,6
99204	104223-42091	2GMF/GMF20, 2QM/QM20, 3GMF/GMF30/QM30, 3HM/HMF/HM35/HM35F	12,75	50,8	22,1



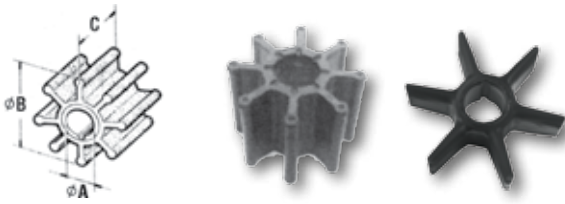

For **MerCruiser** engines

Code	Manufacturer Code	Engine Specifications	Dimensions (mm)		
			A	B	C
97910	47-43026-T2, 47-430262Q02	GEN II Alpha (all)	22,40	89	32,50
97914	47-65960, 47-89984	I & alpha I (6225577-D469859), I(2062141-26633441), I(2663442-6225576), MC 1(1684188-2495185) (1964-1968), MC 1(2495186-2763441) (1968-1969), MC 1/R Alpha (2763442-6854392) (1970-1984), MR Alpha (6854393-D469858 (1984-1990)	22,20	60	33,80

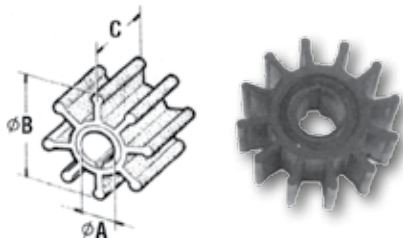

For **Sherwood** pumps

Code	Manufacturer Code	Pump Models	Dimensions (mm)		
			A	B	C
97883	9979	L9960, T11165, T11166	9,54	39,60	18,94
99176	10615K	B04, C03, D05, D55, E35, F10, F75, F95, G1004, G1005, G1006, G1006-01, G1008-01, G26-01, G3, G4, G45-1, G45-2, G46, G5, G50, G5-1, G55-2, G56, G7, G7B, G8, G85, H85, K90, L10, L10B, L80, L90, M71, M71-01, P101, P1012-01, P102, P105, P105-01, P10550G, P109, R101, R102, R10970G, RPBC, S11040G, S11095G	15,90	65,20	41,10
99342	9959K	A03, A16, B06, D55, D60, D65, D75, F15, F85, G1, G15, G2, G20, G21, G21-01, G22-01, G30-2, G30-2B, G65, G95-1, G9901, G9902, G9903, H10, H5, J70, J90, K75B, L9920G, L9930G, 10065G, M10180G, M10210G, M10263G, M10264G, M10270G, M10280G, N10390G, N10410G, N10460, N10470, N10510G, P10550G, P10560G, P10610G, P10650G, P10700G, P10710G, Q10755G, Q10765G, Q10770G, Q10855G, R10870G, R10870G-01, R10920G, R10925G, R10930G, 10935G, R10955G, R40G, R50G, R991, RPGC	15,90	62	31,70
99338	17000K	P171, P1710-02, P1710X, P1711, P1712, P1716B-01, P1716X, P1719, P1719-01, P1719F-01, P172, P1722B-01, P1722X, P1726, P1726TC-02, P1726X, P1727FB-01, P1727X, P173, P1730F-01, P1730X, P1731F-01, P1732-02, P176, P176-02	20	84	73,50
99339	9000K	G11, G903, G905, G906P, G907-01, G907P, G907P-01, G908, G908-01	15,95	62,50	22

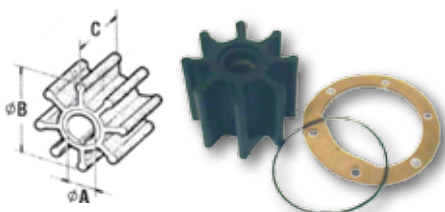

For **Perkins** engines' pumps

Code	Manufacturer Code	Dimensions (mm)		
		A	B	C
97884	0460027	25	95	63,10
97885	24880031	14,2	65	50,20
97897	0460038	14,4	57	31,60
99342	NA900010	15,90	62	31,70
99176	NA900012	15,90	65,20	41,10

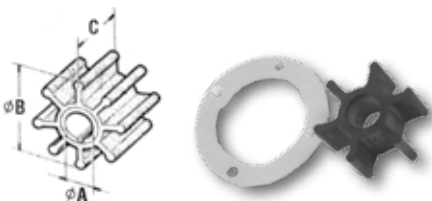

For **Bukh** engines' pumps

Code	Manufacturer Code	Dimensions (mm)		
		A	B	C
97883	610G0102	9,54	39,60	18,94

# Impellers

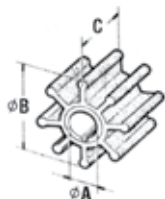

For **Diesel** engines' pumps

Code	Manufacturer Code	Dimensions (mm)		
		A	B	C
97884	5193553	25	95	63,10
97885	5193602	14,2	65	50,20
97886	5196168	25	95	88,50
97887	8924838	25	95	63,10

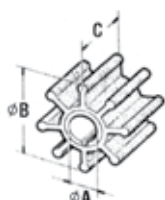

For **Westerbeke** engines' pumps

Code	Manufacturer Code	Dimensions (mm)		
		A	B	C
97903	32620	12	39,60	19,20
99342	11907, 33104	15,90	62	31,70

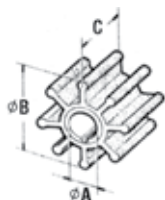

For **Onan** engines' pumps

Code	Manufacturer Code	Dimensions (mm)		
		A	B	C
97883	132-1359	9,54	39,60	18,94
97897	132-1620	14,4	57	31,60
99342	132-0117	15,90	62	31,70

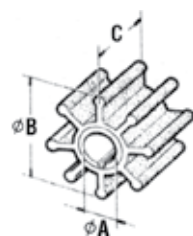

For **Caterpillar** engines' pumps

Code	Manufacturer Code	Dimensions (mm)		
		A	B	C
97884	1L4774	25	95	63,10
97885	3N1906	14,2	65	50,20
97886	4L8470	25	95	88,50
97887	5N9360	25	95	63,10

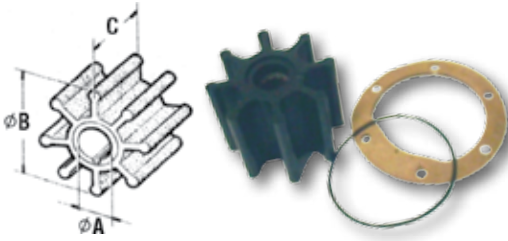

For Volvo-Penta engines' pumps

Code	Manufacturer Code	Pump Models	Dimensions (mm)		
			A	B	C
97883	875807-0, 803729, 3586494	MB10, MD1B, MD1 (SN14016-)/1B, MD2 (SN 4211-), MD2010A/2020A, MD2010B/2020B, MD29, MD2B, MD6A	9,54	39,6	18,94
97884	807904, 875660-3, 875736	AQAD40A / AQAD40B / TAMD40A, TAMD71A / TAMD71B / TAMD72A, TAMD72P-A, TAMD40B/TAMD61A/ TAMD62A	25	95	63,1
97885	875593-6, 877061, 3841697	AD31A / AD31B / AD31D / AD31L-A, AD31P-A / AD31XD / AD41A / AD41B, AD41D / AD41L-A / AD41P-A / AQ70BL, AQ70CL, AQD140A/B, AQAD30A / AQAD31A / AQA41A, AQD30, AQD32A / AQD40A / AQD41A, AQD70B / AQD70C / AQD70D / D41A, D41B - D41D - KAD300 - KAD32P-A, KAD42A - KAD42B - KAD42P -AKAD43P-A - KAD44P-A - KAD44P-B, KAD44P-C - KAMD300 - KAMD42A, KAMD42B - KAMD42P-A - KAMD43P-A, KAMD44P-A - KAMD44P-B - KAMD44P-C, MD30A - MD31A - MD32A - MD40A - MD40B - MD70B - MD70C - TAMD30A, TAMD31A - TAMD31B - TAMD31D, TAMD31L-A - TAMD31MA - TAMD31P-A, TAMD31S - TAMD41A - TAMD41B, TAMD41D - TAMD41H-A - TAMD41L-A, TAMD41M-A - TAMD41P-A, AMD42WJ-A - TAMD60A - TAMD60B, TAMD60C - TAMD70B - TAMD70C, TAMD70D - TAMD70E - THAMD70B, THAMD70C - TMD30A - TMD31A, TMD31B - TMD31D - TMD31L-A, TMD40A - TMD40B - TMD40C, TMD41A - TMD41B - TMD41D, TMD41L-A - TMD70B - TMD70C, TMD100A/TMD100AK/TMD100A-CC	14,2	65	50,2
97898	875808-8	AQ100, AQ110, AQ115A-B, AQ120, AQ90, AQ95-A, BB100, BB115-A-B-C, BB30, MB18-F, MB20A-B-C, MD17C-D, MD2020B (SN 5101203008-), MD2020B (SN 5101203007-), MD2030A-B-C-D, MD2040A-B-C-D, MD3B	12,66	50,8	22,1
97897	875811-2, 3862281, 877400	3.0GL, 3.0GLM-A/B/C, 3.0GS, 3.0GSMBY, 3.0GSMLKD, 3.0GSPLKD, 3.0GSMNCA, 3.0GSMNCS, 3.0GSMWTR, 3.0GSMWTS, 4Gi, 4.3GIJBYA, 4.3GIJWTR, 4.3GIPBYCCE, 4.3GIPEFS, 4.3GIPHUSCE, 4.3GIPLKCE, 4.3GIPLKECE, 4.3GIPNCACE, 4.3GIPNCBCE, 4.3GIPNCMCE, 4.3GIPNCSCE, 4.3GIPWTC, 4.3GIPWTR, 4.3GL, 4.3GL-A/B/C/D, 4.3GLMMDA, 4.3GLPBYC, 4.3GLPHUB, 4.3GLPLKD, 4.3GLPLKE, 4.3GLPMDA, 4.3GLPNCA, 4.3GLPNCB, 4.3GLPNCS, 4.3GLPWTC, 4.3GLPWTR, 4.3GS, 4.3GSJBYA, 4.3GSJLKD, 4.3GSJWTR, 4.3GSJNCC, 4.3GSJNCS, 4.3GSPBYC, 4.3GSPHUB, 4.3GSPHUS, 4.3GSPLKD, 4.3GSPLKE, 4.3GSPMDA, 4.3GSPNCA, 4.3GSPNCB, 4.3GSPNCM, 4.3GSPNCS, 4.3GSPWTC, 4.3GSPWTR, 5.0FIPHUBCE, 5.0FIPHUCE, 5.0FIPHURCE, 5.0FIPHUSCE, 5.0FIPNCACE, 5.0FIPNCBCE, 5.0FIPNCMCE, 5.0FIPNCSCE, 5.0FIPMDA, 5.0Fi, 5.0FiPMDM, 5.0FL, 5.0FLPHUB, 5.0FLPHUC, 5.0FLPHUE, 5.0FLPHUS, 5.0FLPHUS, 5.0FLPMDA, 5.0FLPNCA, 5.0FLPNCB, 5.0FLPNCM, 5.0FLPNCS, 5.0Gi, 5.0GIP-BYCCCE, 5.0GIPPEFS, 5.0GIPWTR, 5.0GL-A/B/C/D/E, 5.0GLPBYC, 5.0GLPEFS, 5.0GLPWTR, 5.7GIIMDA, 5.7GIINCCCE, 5.7GIINCSCE, 5.7GIINCSCE, 5.7GIPHUS, 5.7GIPLKCE, 5.7GIPLKECE, 5.7GIPLKDCE, 5.7GIPLKECE, 5.7GIPMDA, 5.7GIPMDACE, 5.7GIPNCMCE, 5.7GIPNCBCE, 5.7GIPNCSCE, 5.7GIPNCSCE, 5.7GL-A/B/C/D/E, 5.7GLIMDA, 5.7GLIPLKDCE, 5.7GLPLKA, 5.7GLPLKD, 5.7GLPLKE, 5.7GLPLKR, 5.7GLPMDA, 5.7GLPNCS, 5.7GS, 5.7GSI, 5.7GSIICPLKD, 5.7GSII-A, 5.7GSIPBYCCE, 5.7GSIPBYDCE, 5.7GSIP-EFS, 5.7GSIPKDCE, 5.7GSIPLKE, 5.7GSIPWTR, 5.7GSPBYC, 5.7GSPPEFS, 5.7GSPLKD, 5.7GSPLKE, 5.7GSPWTR, 5.7GXI-A/B/D/DF/E/EF/F/FF, 5.8Fi, 5.8FiIHUBCE, 5.8FiIHUECE, 5.8FiPHUBCE, 5.8FiPHUCE, 5.8FiPHUECE, 5.8FiPHURCE, 5.8FiPHUSCE, 5.8FiPMDA, 5.8FiPMDM, 5.8FiPNCACE, 5.8FiPNCBCE, 5.8FiPNCMCE, 5.8FiPNCSCCE, 5.8FL, 5.8FLIHUB, 5.8FLIHUE, 5.8FLINCC, 5.8FLINCS, 5.8FLPHUC, 5.8FLPHUE, 5.8FLPHUR, 5.8FLPMDA, 5.8FLPNCA, 5.8FLPNCB, 5.8FLPNCM, 5.8FLPNCS, 5.8FSi, 7.4GIIHUBCE, 7.4GIINCCCE, 7.4GIINCSCE, 7.4GIPBYCCE, 7.4GIPBYDCE, 7.4GIPLKDCE, 7.4GIPLKECE, 7.4GIPNCACE, 7.4GIPNCBCE, 7.4GIPNCMCE, 7.4GIPNCSCE, 7.4GL, 7.4GLIHUB, 7.4GLIMDA, 7.4GLIMDM, 7.4GLINCC, 7.4GLINCS, 7.4GLPNCA, 7.4GLPNCB, 7.4GLPLKD, 7.4GLPLKE, 7.4GLPMDA, 7.4GLPMDM, 7.4GLPNCA, 7.4GLPNCS, 7.4GLPNCM, 7.4GLPNCB, 7.4GSI, 7.4GSIINCC, 7.4GSIINCS, 7.4GSIIPBYCCE, 7.4GSIIXHUS, 7.4GSIIXNCB, 7.4GSIIXNCM, 8.1GI-A/B/BF/C/CF/D/DF/E/EF/F/FF, 8.1GII-A/B/C/E/F, 8.1GSI-A, 8.1GSI-A, 8.1GSI-A, 8.1GSI-A/AF/BF/C/CF/D/DF/E/EF, 8.1GXII-A/B/C/D/E, 8.1OSI-A/AF/BF, 8.2GL, 8.2GLIMDA, 8.2GLIMDM, 8.2GLPMDM, 8.2GSIPBYCCE, 8.2GSIXNCB, 120S-E, 2003T, 2003TB, 430A, 430B, 431A, 431B, 432A, 434A, 500A, 501A, 501A/MS4, 500B, 501B, 570A, 570A/MS4A, 571A, 572A, 740B, AQ130 A/B/C/D, AQ175A, AQ200D, AQ200F, AQ211A, AQ225D, AQ225 A/B, AQ231A, AQ231B, AQ255B, AQ260A, AQ271A, AQ271B, AQ271C, AQ271D, AQ280A, AQ290A, AQ311A, AQ311B, AQD21A, AQD21B, BB225A, BB225AV, BB225B, BB225C, BB226A, BB226AV, BB226B, BB226C, BB226A, DPX375-A/B/BF/CF, DPX385 XBYDCE, DPX385 XLKE, DPX415XBYDCE, DPX415XLKE, DPX420-A-L-R, MD21A, MD21B, MD22A, MD22L-A, MD22L-B, MD22P-B, MD255, MD275, MS2A-E(Water Pump 858150), MS2B-A-L-R(Water Pump 858150), MS2L-E(Water Pump 858150), TAMD22P-B, TMB22B, TMD22A, TMD22P-C	14,4	57	31,6
97887	877066	TAMD73P-A, TAMD73WJ-A, TAMD74A-A, TAMD74A-B, TAMD74C-A, TAMD74L-A, TAMD74L-B, TAMD74P-A, TAMD74P-B, TAMD75P-A	25	95	63,1
99342	835512-5	AQ225,B/C, AQ200B/C, AQ200A	15,9	62	31,7
99309	876771	TAMD63L-A, TAMD63P-A	25	65,7	80



Boats, Engines & Accessories

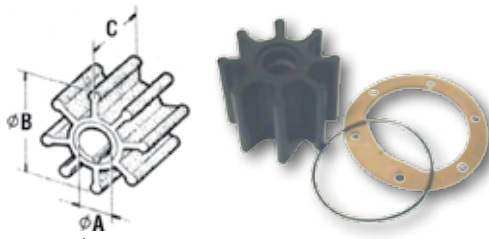

For Oberdorfer engines' pumps

Code	Manufacturer Code	Dimensions (mm)		
		A	B	C
97884	C7054	25	95	63,10
97906	C7441	14,2	65	50,20

# Impellers

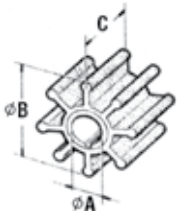

For **Johnson** pumps

Code	Manufacturer Code	Pump Models	Dimensions (mm)		
			A	B	C
97887	09-819B	F8B-3 (10-13024-1), F8B-3000 (10-13024-1), F8B-3000-TSS (10-13175-01), F8B-303 (10-13024-3), F8B-3030 (10-13024-3), F8B-39 (10-13024-2), F8B-393 (10-13024-4), F8B-5 (10-13025-), F8B-5000 (10-13025-99), F8B-5000-TSS (10-13176-99), F8B-5001 (10-13022-99), F8B-50017 (10-13022-95), F8B-50017 (10-13022-96), F8B-50017 (10-13022-98), F8B-8 (10-13021-1), F8B-8 (10-13021-17), F8B-8007 (10-13021-9), F8B-8007 (10-13021-91), F8B-8007 (10-13021-95), F8B-8007 (10-13021-96), F8B-89 (10-13021-2), F8B-9 (10-13008-01), F8B-9 (10-13096-01), F8B-9 (10-13096-02), F8B-9 (10-13180-01), F8B-9 (10-24181-1), F8B-9 (10-24181-3), F8B-900 (10-22096-1), F8B-902 (10-22096-3), F8B-902 (10-24096-4), F8B-903 (10-21915-1), F8B-903 (10-21915-2), F8B-903 (10-24181-4), F8B-905 (10-24130-3), F8B-905 (10-24130-4), F9B/F7B-9 (10-13064-1), F9B/F7B-9 (10-13064-2)	25	95	63,1
97898	09-1026B	F4B/6M (10-24074-1), F4B/F4B-9 (10-35098-2), F4B/F4B-9 (10-24166-1), F4B-903 (10-24463-01), F4B-9 (10-24465-01), F4B-9 (10-35064-1), F4B-9 (10-35098-1), F4B-9 (10-35098-2), F4B-9 (10-35098-3), F4B-9 (10-35098-4), F4B/F4B-9 (10-31917-1), F43-9 (10-32588-1), F4B-9 (10-35024-1), F4B-9 (10-35094-1)	12,66	50,8	22,1
97903	09-0808B	F35B/F35B-9 (10-24143-1), F35B/F35B-9 (10-35157-3), F35B-8 (10-35038-1), F35B-8 (103638-2), F35B-8 (10-35038-3), F35B-8 (10-35038-8), F35B-8007 (10-35038-41), F35B-8007 (10-35038-9), F35B-802 (10-35038-2), F35B-8027 (10-35038-5), F35B-8027 (10-35038-9), F35B-9 (10-24143-3), F35B-9 (10-24143-5), F35B-9 (10-24178-3), F35B-9 (10-35091-1), F35B-9 (10-35118-2), F35B-9 (10-35141-1), F35B-9 (10-35157-), F35B-9 (10-35157-1), F35B-9 (10-35157-2), F35B-9 (10-35157-3), F35B-9 (10-35157-5), F35B-9 (10-35157-6), F35B-9 (10-35157-8), F35B-9 (10-35211-1), F35B-9 (10-35211-3), F35B-9 (10-35211-5), F35B-902 (10-24143-1), F35B-902 (10-24143-2), F35B-902 (10-24178-1), F35B-902 (10-24178-2), F35B-902 (10-35091-2), F35B-902 (10-35141-2), F35B-902 (10-35157-2), F35B-902 (10-35157-3), F35B-902 (10-35157-4), F35B-8 (10-35038-4), F35B-8 (10-35038-5), F35B-8 (10-35038-8), F35B-8 (10-35038-7), F35B-9 (10-234211-1), F35B-9 (10-32415-1), F35B-9 (10-35015-1), F35B-9 (10-35015-2), F35B-9 (10-35015-3), F35B-9 (10-35118), F35B-9 (10-35187-1), F35B-9 (10-35280-1), F35B-9 (10-35211-2), F35B-9 (10-35211-4)	12	39,6	19,2
97904	09-0812B	F6B-9 (10-24232-1), F6B-9 (10-24232-5), F6B-9 (10-24232-6), F6B-9 (10-24234-1), F6B-9 (10-24302-01), F6B-9 (10-24302-02), F6B-9 (10-24316-01), F6B-9 (10-24412-02), F6B-9 (10-24432-02), F6B-9 (10-24493-02), F6B-9 (10-24515-01)	14,5	57	48,2
97905	09-1026B-9	-	12,66	50,8	22,1
97906	09-1028B-9	-	14,2	65	50,2
99170	09-0802B	F7B-3000, F7B-39 (10-24209-2), F7B-3900 (10-24209-2), F7B-393 (10-24209-4), F7B-5000, F7B-5001, F7B-8	25	95	88,5
97897	09-1028B	F9B-3000 (10-13026-1), F9B-3000-TSS (10-13177-01), F9B-3007 (10-13026-7), F9B-303 (10-13027-), F9B-303 (10-13026-2), F9B-9 (10-24072-1), F9B-9 (10-24239-1), F9B-9 (10-24239-2), F9B-900 (10-24090-1)	25	95	88,5
97897	09-1028B	F5B-3 (10-24210-1), F5B-3000 (10-24210-1), F5B-3007 (10-24210-5), F5B-302 (10-24210-3), F5B-3020 (10-24210-3), F5B-8 (10-24073-1), F5B-8 (10-24073-10), F5B-8 (10-24073-11), F5B-8 (10-24073-12), F5B-8 (10-24073-9), F5B-8007 (10-24073-51), F5B-9 (10-24100-1), F5B-9 (10-24119-2), F5B-9 (10-24119-3), F5B-9 (10-24119-4), F5B-9 (10-24119-7), F5B-9 (10-24119-8), F5B-9 (10-24140-1), F5B-9 (10-24140-3), F5B-9 (10-24140-5), F5B-9 (10-24184-1), F5B-9 (10-24210-1), F5B-9 (10-24225-1), F5B-9 (10-24228-1), F5B-9 (10-24228-5), F5B-9 (10-24228-6), F5B-9 (10-24230-3), F5B-9 (10-24268-4), F5B-9 (10-24334-01), F5B-9 (10-24334-02), F5B-9 (10-24372-01), F5B-9 (10-24451-01), F5B-9 (10-24461-01), F5B-9 (10-24508-01), F5B-9 (10-24508-02), F5B-9 (10-32256-1), F5B-9 (10-35100-1), F5B-9 (10-35231-1), F5B-9 (10-35327-1), F5B-9001 (10-24119-1), F5B-9002 (10-24119-2), F5B-9003 (10-24119-4), F5B-9004 (10-24119-5), F5B-9005 (10-24119-6), F5B-9006 (10-24119-7), F5B-902 (10-24131-1), F5B-902 (10-24140-2), F5B-902 (10-24225-2), F5B-902 (10-24230-2), F5B-902 (10-24268-2), F5B-9022 (10-24119-2), F5B-903 (10-35327-03), F5B-905 (10-13159-03), F5B-905 (10-13159-04), F5B-905 (10-13159-05), F5B-905 (10-13159-06), F5B-905 (10-24131-2), F5B-905 (10-24131-4), F5B-905 (10-24318-01)	14,4	57	31,6
99295	09-0810B9	F4B/6M (10-24074-1), F4B/F4B-9 (10-24166-1), F4B/F4B-9 (10-31917-1), F4B/F4B-9 (10-35098-2), F4B-4 (10-24074-1), F4B-9 (10-24465-01), F4B-9 (10-32588-1), F4B-9 (10-35024-1), F4B-9 (10-35064-1), F4B-9 (10-35094-1), F4B-9 (10-35098-1), F4B-9 (10-35098-2), F4B-9 (10-35098-3), F4B-9 (10-35098-4), F4B-903 (10-24463-01)	12,15	50,8	22,1
99309	09-821B	F75B/F7B-9 (10-13142-01), F75B/F7B-9 (10-13142-02), F75B-9 (10-13141-01), F75B-9 (10-13141-02), F75B-9 (10-13153-01), F75B-9 (10-13170-01), F75B-9 (10-24413-01), F75B-9 (10-24413-02)	25	65,7	80
99329	09-1027B-9	F5B-19 12V (10-24188-1), F5B-19 24V (10-24188-2), F5B-3000, F5B-39 (10-24073-3), F5B-39 (10-24210-2), F5B-3900 (10-24210-2), F5B-392 (10-24210-4), F5B-8, F5B-892 (10-24073-4), F5B-39 (10-24073-3)	14,4	57	31,6
97883	09-0806B	F4B-9 (10-35157-3)	9,54	39,6	18,94
99148	09-0810B	F4B/F4B-8 (10-24074-1), F4B/F4B-8 (10-24165-2), F4B-8 (10-24074-1), F4B-8 (10-24074-13), F4B-8 (10-24074-14), F4B-8 (10-24164-1), F4B-8 (10-24164-2), F4B-8001 (10-24074-1), F4B-8007 (10-24074-7), F4B-8007 (10-24074-71), F4B-802 (10-24074-3), F4B-8021 (10-24074-3), F4B-8027 (10-24074-9), F4B-803 (10-24074-5), F4B-8031 (10-24074-5), F4B-8037 (10-24074-11), F4B-9 (10-24144-1), F4B-9 (10-24144-2), F4B-9 (10-24165-1), F4B-9 (10-24166-1), F4B-9 (10-24214-1), F4B-9 (10-24214-4), F4B-9 (10-24290-1), F4B-9 (10-24321-01), F4B-9 (10-24326-01), F4B-9 (10-24335-01), F4B-9 (10-24341-01), F4B-9 (10-24514-01), F4B-9 (10-35142-1), F4B-9 (10-24514-01), F4B-9 (10-35161-1), F4B-9 (10-35167-1), F4B-9 (10-35205-1), F4B-9 (10-35216-1), F4B-9 (10-35240-1), F4B-9 (10-35241-1), F4B-9 (10-35333-01), F4B-9 (10-35355-01), F4B-9 (10-35725-01), F4B-902 (10-24509-02), F4B-902 (10-35167-2), F4B-902 (10-35241-2), F4B-903 (10-24165-2), F4B-903 (10-24166-2), F4B-903 (10-24214-2), F4B-903 (10-24509-01), F4B-903 (10-35142-2)	12,15	50,8	22,1
97884	09-1029B	-	25	95	63,1
97885	09-1028B	F7B-3 (10-22045-1), F7B-3000 (10-24029-1), F7B-3007 (10-24029-7), F7B-303 (10-24029-3), F7B-3 (10-24029-1), F7B-39 (10-24209-2), F7B-5 (10-24116-), F7B-5000 (10-24116-99), F7B-5001 (10-24071-99), F7B-5007 (10-24116-98), F7B-8 (10-24070-1), F7B-8 (10-24070-10), F7B-8 (10-24070-9), F7B-8007 (10-24070-51), F7B-803 (10-24070-3), F7B-9 (10-22335-3), F7B-9 (10-24017-1, partly), F7B-9 (10-24017-2, partly), F7B-9 (10-24061-1), F7B-9 (10-24061-3), F7B-9 (10-24127-1/2/3), F7B-9 (10-24139-1), F7B-9 (10-24139-3), F7B-9 (10-24139-5), F7B-9 (10-24139-7), F7B-9 (10-24179-1), F7B-9 (10-24244-1), F7B-9 (10-24253-2), F7B-9 (10-24253-3), F7B-9 (10-24277-1), F7B-9 (10-24277-3), F7B-9 (10-24277-5), F7B-9 (10-24280), F7B-9 (10-24329-1), F7B-9 (10-24338-01), F7B-9 (10-24349-01), F7B-9 (10-24365-01), F7B-9 (10-24365-02), F7B-9 (10-24386-01), F7B-9 (10-24390-4), F7B-9 (10-24398-01), F7B-9 (10-24428-01), F7B-9 (10-24431-01), F7B-9 (10-24445-01), F7B-9 (10-24524-01), F7B-9 (10-24524-03), F7B-9 (10-24542-01), F7B-9000 (10-24014-1), F7B-9000 (10-24183-1), F7B-9000 (10-24014-2), F7B-902 (10-11236-3), F7B-902 (10-24061-2), F7B-902 (10-24253-1), F7B-902 (10-24277-2/4), F7B-902 (10-24394-02), F7B-902 (10-11236-2), F7B-903 (10-21876-2), F7B-903 (10-22335-2 partly), F7B-903 (10-24017-1), F7B-903 (10-24017-2 partly), F7B-903 (10-24017-2), F7B-903 (10-24017-3), F7B-903 (10-24017-4), F7B-903 (10-24126-1), F7B-903 (10-24126-2), F7B-903 (10-2126-1/2/3), F7B-903 (10-24139-2), F7B-903 (10-24139-4), F7B-903 (10-24179-1), F7B-903 (10-24179-2), F7B-903 (10-24218-1), F7B-903 (10-24244-2), F7B-903 (10-24475-02), F7B-9030 (10-24014-4), F7B-99 (10-24126-2)	14,2	65	50,2
97886	09-0814B	F9B-3000, F9B-3600 (10-13026-4), F9B-5600 (10-13027-99), F9B-5600-TSS (10-1378-99), F9B-5607 (10-13027-98), F9B-9 (10-13080-01), F9B-9 (10-13095-01), F9B-9 (10-13095-02), F9B-9 (10-24430-01), F9B-905 (10-13166-01), F9B-905 (10-13171-01), F9B-905 (10-24006-1), F9B-905 (10-24006-2), F9B-905 (10-24308-02), F9B-905 (10-24308-03)	25	95	88,5

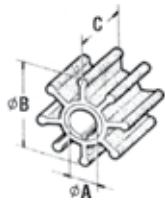

For Jabsco pumps

Code	Manufacturer Code	Pump Models	Dimensions (mm)		
			A	B	C
97904	13554-0001	-	14,5	57	48,2
97905	673-0003	10420, 11000, 11000-01, 11470-200, 11570-200, 22240, 22270, 22360, 22620, 22950-2037, 2620-237	12,66	50,8	22,1
97906	920-0003	11860-0003, 11860-0005, 2300-9003, 2300-9005, 23010-0131, 777-0003, 777-9003, 777-9005	14,2	65	50,2
99174	1414-0003	44720-0000	8,05	31,75	12
99176	18948-0001	-	15,9	65,2	41,1
99148	653-0001	10-35115-2	12,15	50,8	22,1
97897	1210-0001, 3085-0001	10170-0011, 10190-0011, 10550-01, 10550-200, 10550-205, 10950-200, 10950-201, 10950-204, 10950-205, 10950-2101, 10950-2141, 10950-2201, 10950-2241, 10950-2401, 10950-2441, 10950-2451, 10950-2601, 10950-2701, 10970, 10970-21, 11410-200, 11590-204, 11850-0101, 11850-0701, 11850-0711, 14210-0001, 1673-0001, 1673-1001, 1673-9001, 1673-9051, 17410-0001, 18830 series, 18840 series, 21080-200, 21080-204, 21090-200, 21690, 21690-05, 21690-200, 21820-200, 21820-2001, 21820-205, 28500-1251, 29500, 29500-1001, 29500-1101, 29500-1201, 29500-1251, 29500-1351, 29500-1401, 29500-1451, 29500-1501, 29500-3001, 29520-2001, 29530-2001, 3270-20, 3270-000, 3270-0001, 3270-0003, 3270-1951, 3270-200, 3270-205, 3270-2101, 3270-2301, 3270-2401, 3270-241, 3270-251, 3270-261, 3270-271, 3270-2801, 3280-200, 3290-9001, 3370-200, 3370-201, 3370-221, 3370-241, 3370-251, 3370-271, 3380-0001, 3380-200, 3380-221, 3480-9002, 3480-9011, 3890-9011, 52040-2001, 52040-2401, 5560-0001, 5660-0001, 5850-0001, 5850-0001, 5870, 6490-122, 6490-123, 6490-132, 6490-200, 6490-210, 6490-222, 6490-223, 6490-224, 6490-225, 6490-231, 6490-231, 6490-2901, 7120-9001, 7320-9001, 8470-0711, 8470-0911, 9380, 9970-200, 9970-204, 9970-241, 9970-251, 9970-261, 9970-271, 9970-281, 9990-200, 9990-201, 9990-21, 9990-41	14,4	57	31,6
99204	22799-0001	-	12,75	50,8	22,1
97903	22405-0001	22770-1051, 22770-1101, 22950-2031, 23050-1031, 23060-1101, 2620-200, 2620-211, 2620-252, 2620-253, 2620-254, 2620-255, 2620-271, 2620-281, 29300-1001, 29300-2001, 29300-2101, 29300-2101C, 29300-2151C, 29300-2201, 29300-2201C, 29300-2301, 29300-2401, 29300-2401C, 29300-2431, 29300-2501, 29300-2501C, 29300-2601C, 29400-1001, 29400-1051, 29400-1101, 29400-1151, 29450-1101, 29450-1201, 29450-1231, 29450-1301, 29450-1401, 29450-2131, 29490-2001C, 4760, 4760-01, 4760-21, 4760-41, 4760-51, 4760-61, 4760-81, 4760-914760-101, 4760-111, 4760-141, 4760-151, 51510-2001, 51510-9001, 51520-9001, 52010-0051, 52010-2001, 52010-205, 5640, 5660, 6540-200, 6540-201, 6540-21, 6710, 9400, 9400-01, 9400-200	12	39,6	19,2
99307	14609-0001, 14787-0001, 1414-0001	14940-0001, 9040-0511	8,05	31,75	12
99322	6303-0001	12580-0001, 12590-0001, 7600-201	8,07	51,3	22
99329	1210-0003	10170-0011, 10190-0011, 10550-01, 10550-200, 10550-205, 10950-200, 10950-201, 10950-204, 10950-205, 10950-2101, 10950-2141, 10950-2201, 10950-2241, 10950-2401, 10950-2441, 10950-2451, 10950-2601, 10950-2701, 10970, 10970-21, 11410-200, 11590-204, 11850-0101, 11850-0701, 11850-0711, 14210-0001, 1673-0003, 1673-1003, 1673-9003, 1673-9051, 17410-0001, 18830 series, 18840 series, 21080-200, 21080-204, 21090-200, 21690, 21690-05, 21690-200, 21820-200, 21820-2001, 21820-205, 21820-2003, 28500-1251, 29500, 29500-1001, 29500-1101, 29500-1201, 29500-1251, 29500-1351, 29500-1401, 29500-1451, 29500-1501, 29500-3001, 29520-2001, 29530-2001, 3270-20, 3270-000, 3270-0001, 3270-0003, 3270-1951, 3270-20, 3270-200, 3270-205, 3270-2101, 3270-2301, 3270-2401, 3270-241, 3270-251, 3270-261, 3270-271, 3270-2801, 3280-200, 3290-9001, 3370-200, 3370-201, 3370-221, 3370-241, 3370-251, 3370-271, 3380-0001, 3380-200, 3380-221, 3480-9002, 3480-9011, 3890-9011, 52040-2003, 52040-2401, 5560-0001, 5850-0001, 5870, 6490-122, 6490-123, 6490-132, 6490-200, 6490-210, 6490-222, 6490-223, 6490-224, 6490-225, 6490-231, 6490-2901, 7120-9001, 7320-9001, 8470-0711, 8470-0911, 9380, 9970-200, 9970-241-37, 9970-251, 9970-261, 9970-271, 9970-281, 9990-200, 9990-201, 9990-21, 9990-41, 9970-204, 9970-241	14,4	57	31,6
97883	4528-0001	4780, 11260-200, 11260-205, 11260-2101, 11260-211, 11260-2151, 11260-2211, 11430-01, 11620-200, 11620-211, 11650-200, 11720-0001, 21130-200, 21130-2101, 22230-200, 22350-200, 22820-2051, 22820-2101, 22830-20001, 22830-2051, 22830-2101, 22830-2151, 22830-2201, 22830-2301, 22940-2001, 22940-2051, 22960-1001, 22960-2001, 22960-2001, 29350-1101, 29350-1101, 9360, 9430, 9430-01, 9430-21, 9430-211, 9430-51, 9560, 6640-200, 6640-205, 4530-0001, AL/200, AL/204	9,54	39,6	18,94
97884	836-0001	10630, 10630-01, 10630-07, 10630-200, 10630-207, 10630-57, 10650, 10650-200, 10670, 10670-01, 10670-10, 10670-11, 10670-200, 10670-201, 10670-210, 10670-211, 10770-0051, 10770-0151, 10770-0331, 10770-0351, 10770-07, 10770-57, 10770-62, 10880-0101, 10880-07, 10880-21, 10880-62, 10890-01, 11790, 11790-1, 21090-204, 21180, 21180-05, 21780, 21810-01, 21980, 29750-1001, 4360, 4800-101, 4800-111, 4800-161, 4800-171, 4800-21, 4800-21-01, 4800-41, 4800-51, 4800-53, 4800-54, 4800-71, 6400-200, 6400-205, 6400-207, 6590-200, 7870-200, 7870-201, 7870-221, 7870-231, 7870-251, 823-200, 823-205	25	95	63,1
97885	920-0001	23010-0131	14,2	65	50,2
97886	17936-0001, 21676-0001	10490, 1490-0201, 10490-07, 10490-207, 10590, 10590-0031, 10590-0041, 10590-01, 10590-0111, 10590-0141, 10590-0201, 10590-21, 10590-22, 10590-0341, 10590-61, 10590-62, 105690-63, 10660, 10660-200, 10680, 10680-01, 10680-10, 10680-11, 10680-200, 10680-201, 10680-210, 10680-211, 11100-31, 11100-01-01, 11110-0141, 11110-0151, 11110-0541, 11150-0011, 18300-0000, 18310-0000, 18320-0000, 18320-0001, 18320-0002, 18340-0000, 18370-0000, 21990, 22040-01, 22040-0131, 22040-0501, 22040-0531, 50270-0011, 50270-0111, 50270-0211, 50270-0311, 50270-0911, 50270-2011, 50270-2111, 50270-2211, 50270-2311, 50270-2911, 51270-0001, 51270-0011, 51270-2011, 52270-0011, 52270-2011, 52270-2041	25	95	88,5
97887	17935-0001	10770-0111, 10880-0051, 10880-0151, 10880-2461, 10880-2561, 10880-2611, 10980-0051, 11870-0007, 21680-05, 2570-0011, 297700-0001, 11870-0005, 50200-2011, 50200-2111, 50200-2311, 50220-0011, 50220-0111, 50220-0211, 50220-0311, 51200-2011, 51220-0011, 52200-2001, 52200-2011, 52200-2041, 52200-2051, 52200-0011, 52220-0041, 52220-0051, 6400-0001, 6400-0004, 6400-0051, 6590-0001, 6590-0004, 7420-0001, 7420-0004, 7420-0101	25	95	63,1
97894	4568-0001	4560-0001, 4900-01, 4900-200, 4900-201, 4900-205, 4410, 4560-0003	16	57	31,65
97898	673-0001	10420, 11000, 11000-01, 11470-200, 11570-200, 22360, 22620, 22770, 22770-1051, 22770-1101, 22950-2031, 23050-1031, 23060-1101, 2620-200, 2620-211, 2620-252, 2620-253, 2620-254, 2620-271, 2620-255, 2620-281, 29450-1101, 29450-1201, 29450-1231, 29450-1301, 29450-1401, 29450-2131, 29490-2001C, 4760, 4760-01, 4760-101, 4760-111, 4760-141, 4760-151, 4760-21, 4760-41, 4760-51, 4760-61, 4760-71, 4760-81, 4760-91, 5640, 5660, 6540-200, 6540-201, 6540-211, 6710, 9400, 9400-01, 9400-200, 22240	12,66	50,8	22,1
97900	7273-0003, 6303-0003	12550-001, 12560-0001, 12570-0001, 12580-0001, 16360-0003, 16360-1003, 16380-0003, 16380-1003, 17260-0003, 17260-0023, 17260-0033, 18590-0000, 18590-0001, 18590-0002, 18590-0010, 18690-0000, 18690-0010, 6360-0001, 6360-1001, 6370-0001, 6370-1001, 6380-0001, 6380-1001, 12590-0011	8,07	50,8	22,1
99295	653-0003	10-3545-2	12,15	50,8	22,1
99170	6760-0001	-	25	95	88,5



Boats, Engines & Accessories

# Impellers

Code	Manufacturer Code	Pump Models	Dimensions (mm)		
			A	B	C
99171	17937-0001	10800-21, 11120-200, 11120-204, 11120-205, 11600, 11740-200, 11740-205, 11860-0001, 11860-0006, 11860-0007, 12280-0001, 17100 series, 17100-0001, 17100-0005, 17100-0011, 21100, 21140-200, 21140-201, 21140-204, 21140-2101, 21140-2141, 21140-2201, 21140-2241, 21140-2401, 21140-2441, 21140-2601, 21140-2641, 21140-2701, 21580-200, 21880-200, 21880-205, 21960-200, 21960-210, 21960-211, 21960-221, 22690-200, 2300-9001, 2300-9004, 23010-0531, 23320-2001, 23320-2101, 23430-1001, 23430-1031, 23430-1041, 23430-1051, 23430-1201, 23430-1241, 23430-1251, 23430-1301, 23430-1401, 23430-1441, 23430-1501, 23430-1601, 23430-1641, 23430-1901, 23430-1701, 23480-2001, 29600-1001, 29600-1101, 29600-1201, 29620-2001, 29630-1001, 3590-9001, 50080-2001, 50080-2101, 50080-2201, 50080-2301, 50080-2321, 51080-2001, 51080-2041, 52080-2001, 52080-2041, 5330-9001, 5330-9101, 6030-21, 6030-41, 6030-61, 6030-71, 6420-0101, 6420-200, 6420-2001, 6420-204, 6420-2041, 6420-205, 6420-2051, 6520-205, 6520-251, 6520-51, 6520-200, 777-0001, 777-9001, 777-9004, 777-9051, 52080-2051, 8170-9001, 9700, 9700-01, 9700-04, 9700-05, 9700-101, 9700-131, 9700-141, 9700-151, 9700-162, 9700-171, 9700-181, 9700-21, 9700-241, 9700-41, 9700-51, 9700-61, 9700-71, 9710, 9710-200, 9710-201, 9710-204, 9710-205, 9710-210, 9730, 9750, 9760, 9770-200, 9770-205	14,2	65	50

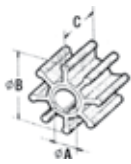

For **Garoni 1"** pumps

Code	Manufacturer Code	Dimensions (mm)		
		A	B	C
98556	Garoni 1"	16	65,50	50

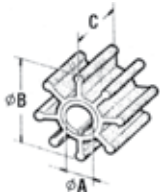

For **Cummins** engines' pumps

Code	Manufacturer Code	Dimensions (mm)		
		A	B	C
97884	10556540	25	95	63,10
97885	650607	14,2	65	50,20

# Sacrificial Anodes



**Propeller Nut Anode**

Code	Dimensions	Weight (kg)
90228	Ext. Diam. 32mm, for 19mm shaft	0,09
90229	Ext. Diam. 41mm, for 22mm shaft	0,23
90230	Ext. Diam. 48mm, for 25mm & 29mm shaft	0,45
90231	Ext. Diam. 54mm, for 32mm shaft	0,68
90240	Ext. Diam. 60mm, for 35mm shaft	0,80
90241	Ext. Diam. 65mm, for 38mm shaft	0,91
90242	Ext. Diam. 73mm, for 45mm shaft	1,32
90251	Ext. Diam. 83mm, for 51mm shaft	1,48



**Conical Anode for Shaft**

Code	Weight (kg)
93012	0,14
93013	0,28
93014	0,25
93015	0,49
93016	0,77



**Max-Prop Anode**

Code	Diameter (mm)	Weight (kg)
93095	54	0,29
93096	67	0,52
93097	79	0,75



**Hull Anode with Welding Strip**

Code	Dimensions (mm)	Weight (kg)
96018	127x121x28	1
96020	178x76x38	2



**Hull Anode**

Code	Dimensions (mm)	Weight (kg)
96014	138x95	2



**Hull Anode, Square Model**

Code	Dimensions (mm)	Weight (kg)
96011	95x33	0,20
96012	116x43	0,50
96013	118x60	1

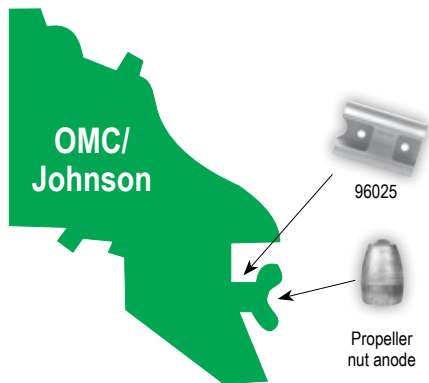

**Anode for In/Outboard OMC/Johnson Engines**

Code	Description	Weight (kg)
96025	Curved block, for engines 40-V8 1988-1991 (except 40-50 1989-1992)	0,27

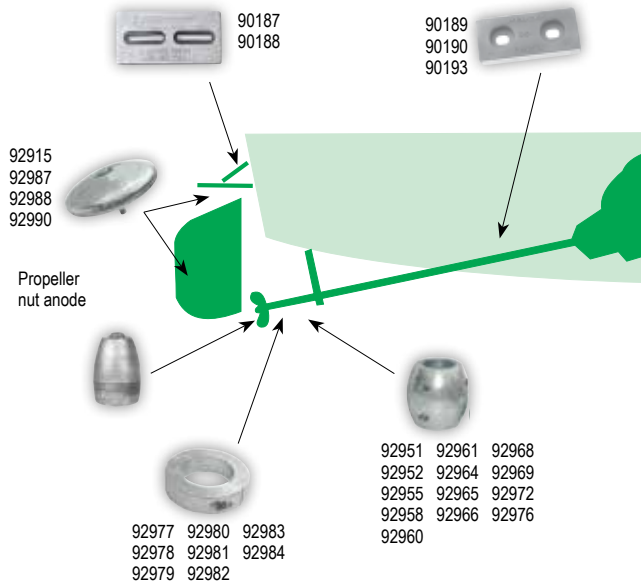

**Anodes for Use in Inboard Engines**

Code	Description	Weight (kg)
90189	Pleasurecraft Hull Anode, 146x64x19mm	0,94
90190	Pleasurecraft Hull Anode, 159x70x19mm,	0,91
90193	Pleasurecraft Hull Anode, 203x102x19mm	2,05
90187	Pleasurecraft Hull Anode, 305x152x13mm	3,60
90188	Pleasurecraft Hull Anode, 152x102x13mm	1,02
92915	Rudderanode, w/ bolt & two disc diam. 47mm	0,13
92987	Rudderanode, w/ bolt & two disc diam. 71mm	0,43
92988	Rudderanode, w/ bolt & two disc diam. 95mm	0,73
92990	Rudderanode, w/ bolt & two disc diam. 127mm	1,46
92977	Shaft anode round, collarshape Int. Diam 19mm, Ext. Diam. 54mm	0,30
92978	Shaft anode round, collarshape Int. Diam 22mm, Ext. Diam. 54mm	0,29
92979	Shaft anode round, collarshape Int. Diam 25mm, Ext. Diam. 63mm	0,55
92980	Shaft anode round, collarshape Int. Diam 32mm, Ext. Diam. 63mm	0,52
92981	Shaft anode round, collarshape Int. Diam 35mm, Ext. Diam. 76mm	0,73
92982	Shaft anode round, collarshape Int. Diam 40mm, Ext. Diam. 76mm	1,22
92983	Shaft anode round, collarshape Int. Diam 44mm, Ext. Diam. 89mm	1,03
92984	Shaft anode round, collarshape Int. Diam 51mm, Ext. Diam. 89mm	0,95
92951	Shaft anode round, Int. Diam. 19mm, Ext. Diam. 54mm	0,35
92952	Shaft anode round, Int. Diam. 22mm, Ext. Diam. 54mm	0,41
92955	Shaft anode round, Int. Diam. 25mm, Ext. Diam. 54mm	0,39
92958	Shaft anode round, Int. Diam. 28mm, Ext. Diam. 54mm	0,49
92960	Shaft anode round, Int. Diam. 30mm, Ext. Diam. 58mm	0,55
92961	Shaft anode round, Int. Diam. 32mm, Ext. Diam. 63mm	0,53
92964	Shaft anode round, Int. Diam. 35mm, Ext. Diam. 63,5mm	0,67
92965	Shaft anode round, Int. Diam. 38mm, Ext. Diam. 63,5mm	0,73
92966	Shaft anode round, Int. Diam. 40mm, Ext. Diam. 82mm	1,20
92968	Shaft anode round, Int. Diam. 44mm, Ext. Diam. 82mm	1,07
92969	Shaft anode round, Int. Diam. 51mm, Ext. Diam. 82mm	1,34
92972	Shaft anode round, Int. Diam. 57mm, Ext. Diam. 82mm	2,35
92976	Shaft anode round, Int. Diam. 76mm, Ext. Diam. 120mm	2,97

# Sacrificial Anodes



## Anodes for In/Outboard Mercruiser Engines

Code	Description	Weight (kg)
96041	Bravo Lift Ram Horsehoe (Gen II)	0,35
90198	Horsehoe	0,10
90223	Bearing carrier Bravo II	0,15
90195	Finshape	0,59
90196	Finshape	0,36
90200	Finshape	0,55
90224	Circular Plate	0,31
90209	Circular Plate	0,33
96040	Screwnut	0,11

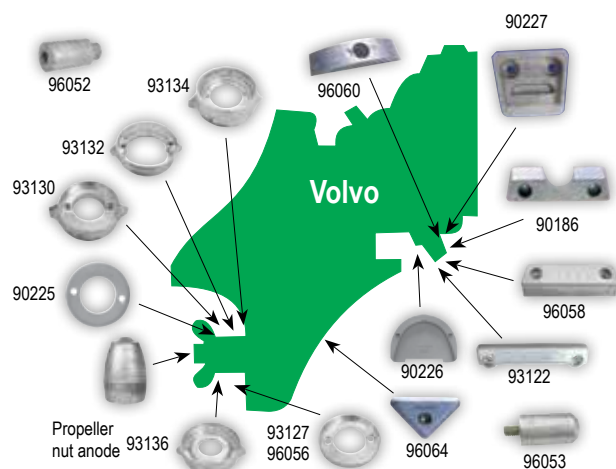

## Anodes for In/Outboard Volvo Engines

Code	Description	Weight (kg)
90227	Gimbal Plate for engines SX Drive	1,09
96060	Folding Prop, for engines 100s, 110s, 120, S-B, S-C	0,05
93134	Collar for saildrive engine	0,92
93132	Collar for duotrop	0,58
93130	Collar	0,73
90225	Collar	0,20
93136	Collar	0,49
93127	Collar	0,20
96056	Collar	0,29
96064	Triangle shape, for engines 290, 290DP, SX, DP-X	0,11
90226	Transom Plate, for SX Drive engines	1,04
93122	Bar lower plate, for engines VO 250/270/280	0,95
90186	Plate	0,65
96058	Bar for duoprop	0,76
96053	Plug	0,14
96052	Plug	0,05

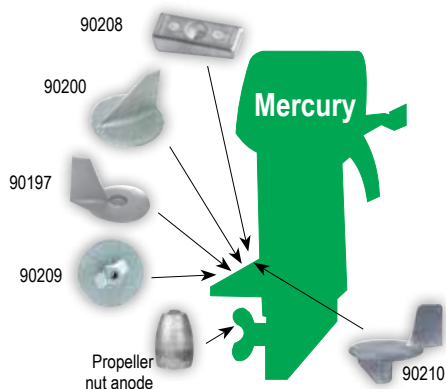

## Anodes for Outboard Mercury Engines

Code	Description	Weight (kg)
90200	Finshape	0,55
90197	Finshape, for engines 30-40hp	0,48
90209	Circular Plate	0,33
90210	Finshape, for engines 18-25hp	0,42
90208	Wedge	0,25

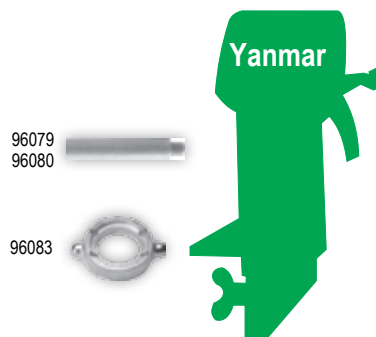

## Anodes for Yanmar Engines

Code	Description	Weight (kg)
96079	Plug	0,20
96080	Plug	0,07
96083	Saildrive Ring	0,85



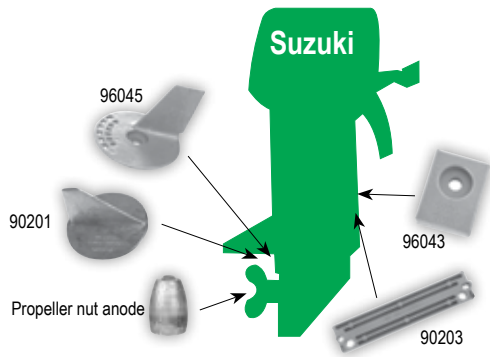

**Anodes for Outboard Suzuki Engines**

Code	Description	Weight (kg)
96045	Finshape for engines 55/60hp	0,13
90201	Finshape	0,34
90203	Bar	0,51
96043	Finshape for engines 65/75/110/115hp	0,08

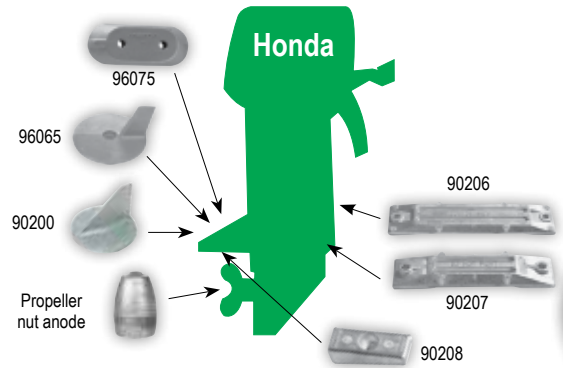

**Anodes for Outboard Honda Engines**

Code	Description	Weight (kg)
96075	Small Block	0,10
96065	Finshape	0,28
90200	Finshape	0,55
90208	Wedge	0,25
90207	Large bar, for engines 75-115hp	0,83
90206	Small bar, for engines 35-50hp	0,36

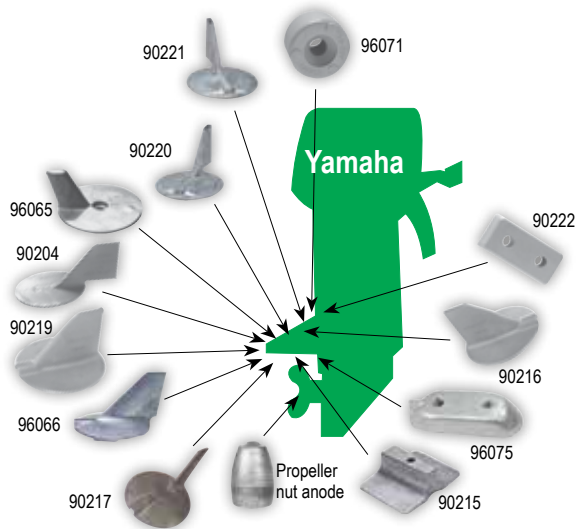

**Anodes for Outboard Yamaha Engines**

Code	Description	Weight (kg)
96071	Round	0,03
90221	Finshape with counter rotationm	0,41
90220	Finshape	0,50
96065	Finshape	0,28
90204	Finshape	0,48
90219	Finshape with counter rotationm	0,42
96066	Finshape	0,63
90217	Finshape	0,52
90215	Cutdown Skeg	0,26
96075	Plate	0,10
90216	Finshape	0,42
90222	Small block	0,14

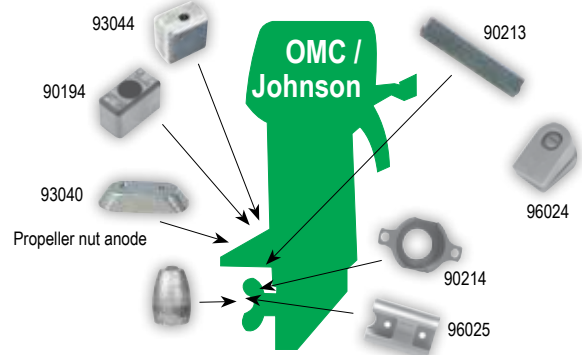

**Anodes for Outboard OMC/Johnson Engines**

Code	Description	Weight (kg)
90213	Long Bar for power trim and tilt	0,72
93044	Cube	0,22
90194	Cube	0,33
93040	For engines 2/150HP	0,09
96025	Curved block, for engines 40-V8 1988-1991 (except 40-50 1989-1992)	0,27
90214	Donut Shape	0,15
96024	Double plate, for engines 20-35hp	0,23

Boats, Engines & Accessories

Diablo



DIABLO Fixed Fuel Tank

DIABLO line of fixed tanks is made of recyclable HDPE material, consisting of a full range of 10 models complying with international standards. DIABLO can be used for fuels such as gasoline, diesel, ethanol, alternative fuels and organic vegetable oils. The advantage of this line of tanks is the 'EASY SWITCH' plate, which can be purchased separately based on the use of the tank, and is manually interchangeable. The plate used for gasoline is in red colour. It is secured and sealed by rotation of the piece itself and is blocked into position by means of a locking pin that prevents loosening. To clean the tank just lift the locking pin and remove the plate by unscrewing it.

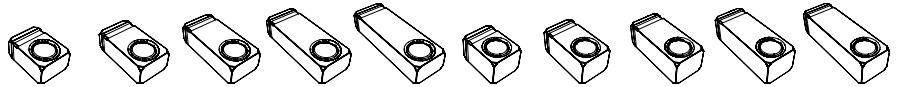
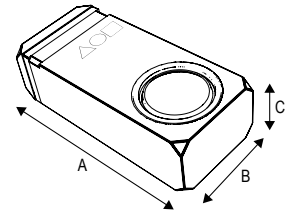

Code	197477	197478	197479	197480	197481	197482	197483	197484	197485	197486
Capacity (lt)	37	48	60	70	82	49	64	78	93	108
A - Length (mm)	500	650	800	950	1100	500	650	800	950	1100
B - Width (mm)	360	360	360	360	360	360	360	360	360	360
C - Height (mm)	230	230	230	230	230	305	305	305	305	305



Boats, Engines & Accessories



DIABLO Easy Switch Blind Plate, without Connectors

Code | 197490

Sensor (optional)

Impedance (Ohm)	0-190	240-33
h=230mm	197348 (200mm)	197357 (200mm)
h=305mm	197350 (300mm)	197359 (300mm)



DIABLO Easy Switch Fuel Plate

Fuel hatch with gasket, complete with:  
 - Connector 90°, Ø38 mm, 1/2" thread  
 - Connector 90°, Ø17 mm, 3/4" thread  
 - Connector 90°, Ø11 mm, 1/2" thread  
 - Caps 1/2" thread, 3/4" thread and 1/2" thread

Code | 197487

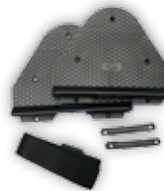

Bracket for Battery Box/Fuel Tank, with Strap 1,50m

Code | 43897



197492, 197495, 197497

197493, 197494, 197496

197501

Code	Description	197487 The Easy Switch Fuel Plate features:
197492	DIABLO Easy Switch Connector 90°, Ø38mm, 1/2" thread	1
197493	DIABLO Easy Switch cap 1/2" thread	1
197494	DIABLO Easy Switch cap 3/4" thread	2
197495	DIABLO Easy Switch Connector 90°, Ø17mm, 3/4" thread	1
197496	DIABLO Easy Switch cap 1/2" thread	1
197497	DIABLO Easy Switch Connector 90°, Ø11mm, 1/2" thread	1
197501	DIABLO Easy Switch Internal Gasket Ø235 x 17,5mm	1



**Ercole**



**ERCOLE Fixed Fuel Tank**

ERCOLE line of horizontal fuel tanks is made of polyethylene material in black colour to avoid rust and has a longer lifetime, contrary to metal tanks. This line consists of a full range of 9 models complying with international standards and is used for fuel collection and storage. All contain a fuel output for Ø8mm hose and a fuel supply input that is either threaded with a cap, either with a vertical outlet for Ø38mm hose, either with an 45°-angled outlet for Ø38mm hose. Pre-cut for tank level sensor.

Code	Type	Capacity (lt)	A Length (mm)	B Width (mm)	C Height (mm)	Connector Pipe Ø (mm)	Deck Filler	Sensor (optional)
44797	With filler cap	41	500	350	300	8	Thread Ø 50mm	197349 (250mm)
44799		55	650					
44801		69	800					
50195	Without cap	41	500	350	300	8	Straight Ø 38mm	197358 (250mm)
50199		55	650					
50205		69	800					
50196	Without cap	41	500	350	300	8	45° Ø 38mm	196911 (233mm)
35008		55	650					
50206		69	800					

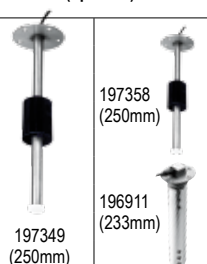

197341  
197342



197343  
197344

**Combine with**

Fuel hose  
page 159



**Sogliola**

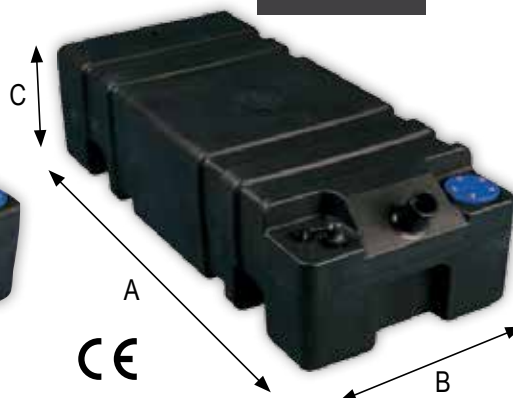

**SOGLIOLA Fixed Fuel Tank**

SOGLIOLA line of fixed tanks is used for storing petrol, diesel or fuel containing ethanol or methanol, before it is transmitted to the boat engine. SOGLIOLA line of horizontal fuel tanks is made of polyethylene material in black color to avoid rust and has a longer lifetime, contrary to metal tanks. The line consists of a full range of 9 models complying with international standards and is used for fuel collection and storage. All contain a fuel output for Ø8mm hose and a fuel supply input that is either threaded with a cap, either with a vertical outlet for Ø38mm hose, either with an 45°-angled outlet for Ø38mm hose. Pre-cut for tank level sensor.

Code	Type	Capacity (lt)	A Length (mm)	B Width (mm)	C Height (mm)	Connector Pipe Ø (mm)	Deck Filler	Sensor (optional)
44832	With filler cap	38	650	350	220	8	Thread Ø 50mm	197347 (150mm)
44834		49	800					
44836		73	1100					
50209	Without cap	38	650	350	220	8	Straight Ø 38mm	197356 (150mm)
50214		49	800					
50218		73	1100					
35009	Without cap	38	650	350	220	8	45° Ø 38mm	197365 (150mm)
50215		49	800					
50219		73	1100					

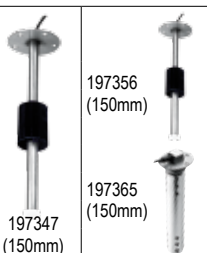

197341  
197342



197343  
197344



## Ercole - Sogliola

Code	Description
45284	A Tank Filler Cap
44467	C Fuel Pick-up Tube w/Pipe Conn. Ø8mm
50140	D Water Pick-Up Tube w/ Ø16mm Conn
44088	FGHE Set Connectors, w/Ø50mm, Straight
44089	GHI Set Connectors, w/Ø38mm, Straight
43366	E Straight Connector Ø50mm
43368	I Straight Connector Ø38mm

Code	Description
44090	FGHM Set of Connectors, w/Ø50mm, 90° Elbow
44091	GHN Set of Connectors, w/Ø38mm, 90° Elbow
43370	M Elbow Connector 90°, Ø50mm
43374	N Elbow Connector 90°, Ø38mm
44624	F Elbow Conn. 90°, Pipe f/Fuel Return
44569	P Vent. Elbow Conn. 90°, Hose Ø16mm
44838	Q Universal Bracket with Holding Straps for Ercole, Sogliola, Diablo Tanks and Liferafs

Boats, Engines & Accessories

## Hulk



### HULK Portable Fuel Tank

HULK line of portable outboard motor fuel tanks is made of odor-free high-density polyethylene material in red colour. Their robust rotationally moulded plastic construction makes them completely non-corrosive. They are strong, yet lightweight and will not crack or dent. Polyethylene material is used since it is unable to rust and has a longer lifetime, contrary to metal tanks. The line consists of a full-size range of 12L, 22L and 30L, complying with international standards and is used for fuel collection and storage. All contain a Ø8mm outlet with filter and a vented cap with seal. The codes 44804 and 44805 contain a fuel gauge, as well.

Code	Capacity (lt)	A Length (mm)	B Width (mm)	C Height (mm)	Fuel Gauge
44803	12	410	260	195	No
44804	22	460	305	265	Yes
44805	30	510	360	270	Yes

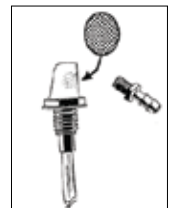

Ø8mm outlet with filter

## Jerrycan

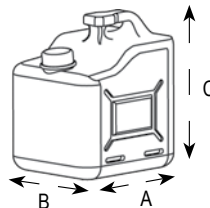

### JERRYCAN Portable Fuel Tank with Spout

JERRYCAN line of portable outboard motor fuel tanks with spout is designed in odor-free high-density polyethylene material in red colour. Polyethylene material is used to avoid rust and has a longer lifetime, contrary to metal tanks. All codes have a top handle that makes them very stable in use and easy to grip and carry, if needed. Their specially designed bottom in large dimensions achieves better stability when placed. The line consists of a full-size range of 5L, 10L, 15L and 22L, complying with international standards and is used for fuel collection and storage. All contain a vented cap with seal, and they are being supplied with a spout.

Code	Capacity (lt)	A Length (mm)	B Width (mm)	C Height (mm)
43604	5	300	240	185
43598	10	300	240	250
43600	15	300	240	330
43602	22	300	245	440



**Portable Fuel Tank with Filter**

Suitable for outboard motors. It is made of odor-free high-density polyethylene material in red colour to avoid rust and has a longer lifetime, contrary to metal tanks. The line consists of 10L and 25L sizes, complying with international standards and is for fuel collection and storage. All contain a vented cap with seal and a Ø 8mm outlet with filter. The code 44789 can be suitable for diesel by adding 44624 (Pipe fuel return).

Code	Capacity (lt)	Length (mm)	Width (mm)	Height (mm)	Fuel Gauge
44790	10	330	245	135	No
44789*	25	440	295	210	Yes

\*Suitable for diesel by adding 44624 (Pipe fuel return)

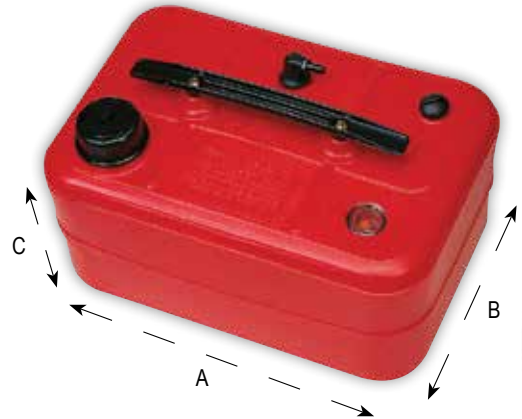
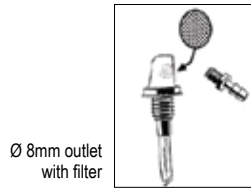

**Storage Bottles**

Ideal for storing safety equipment, medicine or personal belongings. Silicone gasket for optimum water resistance. You can also use a carrying rope.

Code	Capacity (lt)	Diameter (mm)	Height (mm)
39642	6	240	195
39643	8		260
39644	12		380
39645	15		440



**MISTRAL Fuel Tank with Sender**

MISTRAL tank for horizontal fuel storage is made of polyethylene material in white colour, offering high chemical and fire resistance. Polyethylene material is used to avoid rust and has a longer lifetime, contrary to metal tanks. This model complies with international standards and is used for fuel collection and storage. MISTRAL tank features one central column to provide increased rigidity of the tank and can be easily secured to the boat. Contains lateral baffles, designed to reduce fuel tossing.

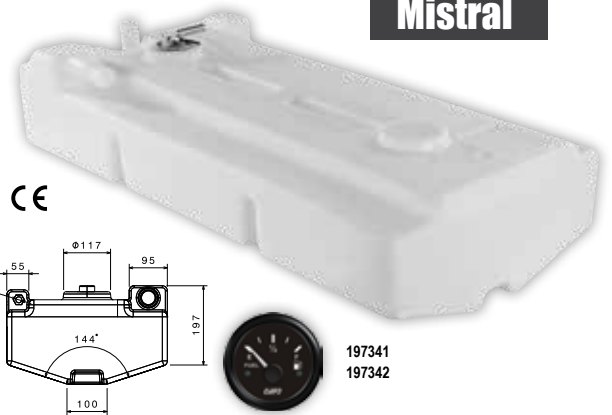
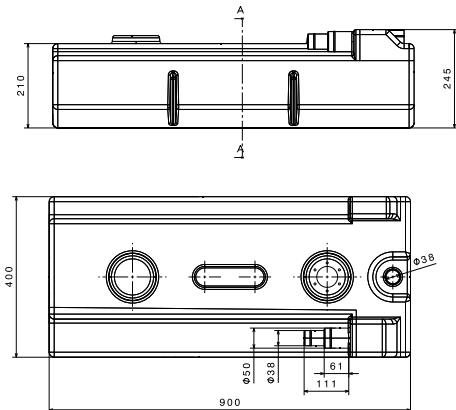

Code	Capacity (lt)	Length (mm)	Width (mm)	Height (mm)	Connectors			Sender
					Ø A (mm)	Ø B (mm)	Ø C (mm)	
196251	55	900	400	245	38	38	50	 197070 0-190 Ohm

\*For diesel tank use sender 197073



**Shut-off Valve, 1/4"**

Code | 90629



**Fuel Line 3-way Valve, 6.5mm**

Code | 99564



**4-way Valve, Three Female 1/4" NPT, Brass**

Code | 99086

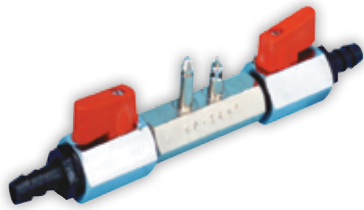

**Fuel Valve 2-way, Hose Ø 10 mm**

Code	For engines
43707	OMC - JOHNSON - EVINRUDE.
43708	YAMAHA - MARINER - MERCURY - HONDA.



**Fuel Valve Shut-off for Hose Ø8mm**

Code	44631
------	-------

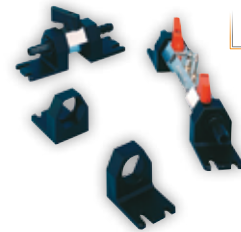

**Fuel Valve Holding Bracket (Pair)**

Code	45186
------	-------



**Diverter Valve, 3-way, for Tanks**

The 3-way Diverter Valve for Tanks is a universal valve that can be used installed on board or on bilge evacuation systems. It allows the operator to choose between two outlets.

**Features**

- Corrosion resistant ABS and stainless steel structure
- Ideal for marine sewage and bilge pump out systems
- Ports: 1-1/2" ID flexible hose
- Can be padlocked
- Long distance control by means of a push-pull cable.

**Bilge systems:** For boats having two separate bilge areas, the 3-way Diverter allows to empty either one, with only one pump.

**Sewerage systems:** When installed in the holding tank discharge line, the y-valve allows the choice between pumpout through a deck fitting or directly through a seacock. When installed in the marine toilet discharge line, it allows the choice between storing the effluent in the waste tank or discharging it directly overboard (if legal).

Code	196791
------	--------



**Bio-Carbon Filter for Nuova Rade Tanks, Ø16-19mm**

Code	51732
------	-------



**Oil Measurer**

Code	26897
Diameter	58mm
Height	120mm



**Bailer Funnel with Filter, Red**

Code	44677
Length	290mm
Width	110mm



**Filler Cap with Vent for Portable Fuel Tanks**

Code	45301
------	-------



**Funnel, Flexible with Filter & Extension**

Code	31354
Diameter	135mm



**Funnel with Filter**

Code	27480
Diameter	180mm
Height	240mm



**Extension for Funnel 27480**

Code	37350
Length	250mm



**Spout for JERRYCAN Portable Fuel Tanks**

Code	45415
------	-------



**Strap for Fuel Tank/ Battery Box Fixing, Length 1,30m**

Code	43895
------	-------



**Bracket for Battery Box/Fuel Tank, with Strap 1,50m**

Code	43897
------	-------



**Fitting for Tank Vent**

Code	Hose Diameter (mm)
44567	16
44568	20



**Connector Ø1/4"**

Code	Description
43451	For Line Plastic Ø8mm

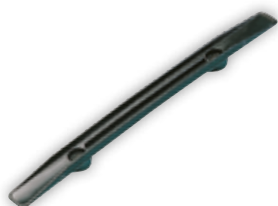

**Handle for Portable Fuel Tank, L310mm, Black**

Code | 44179



**Pick-up Tube with Filter & Pipe Connector Ø1/4"**

Code | 44469



**Universal Base with Strap**

Code | 43901

External Dimensions: 485x340x35 mm  
Internal Dimensions: 470x320 mm



**Hose Pump, Manual Suction, Transparent**

This corrugated hose pump is great to outfit your boat for optimum customisation and maintenance. Allows quick and safe transfer of liquids from one container to another. High-quality and durable PVC material. Suitable for petrol, diesel, water.

Code	Diameter (mm)	Length (cm)	Hose	Hose Thickness	Flow Rate
70002	12,5	160	PVC	2mm	3,5 gallons/min
70003	22,5			3mm	10 gallons/min

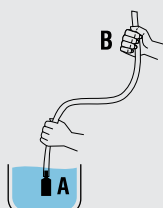

1. Place the bottom end A of the hosepipe into the tank with the liquid that you wish to pump out and hold the top end B of the hosepipe upright

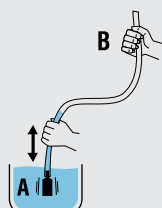

2. Shake the bottom end of the hose vigorously up and down until the liquid rises in the hose, continue pumping until the liquid passes balance level

**ATTENTION:** Make sure that the empty container is placed below the level of the container you wish to empty

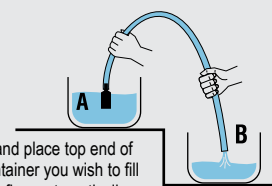

3. Stop pumping and place top end of the hose in the container you wish to fill and the liquid will flow automatically

## Fuel Hoses & Connectors



**Fuel Primer Bulb with Hose Ø8mm**

Code	45386	31958
Hose Material	PVC	
Hose Length (m)	2	
Buld Diameter (mm)	39	45
Bulb Code	44476	31957



**Fuel Primer Bulb with Hose Ø8mm**

Code	45387	45388
Hose Material	PVC fiber reinforced	
Hose Length (m)	2	3
Buld Diameter (mm)	45	
Bulb Code	31957	

\*With filter



**Fuel Primer Bulb for Hose Ø8mm**

Code	44476	31957
Diameter (mm)	39	45
Length (mm)	130	150
Hose Diameter (mm)	8	

**new**



**Fuel Primer Bulb with Hose Ø 8mm & Connectors**

Code	Bulb Diameter (mm)	Hose Material	Hose Length (m)	Bulb Code	Connectors for Engine	Connectors Code
198147	39	PVC	2	45386	Yamaha	31942
198148				45386	OMC	31941
198149	45	PVC fiber reinforced		45387	Yamaha	31942
198150				45387	OMC	31941

Boats, Engines & Accessories



**Mercury 1998 > / Mariner**

**Fuel Line Tank Male Connector with Ø9,5mm Barb**

Code | 43308



**Fuel Line Tank Male Connector with Ø8,5mm Barb**

Code | 43314

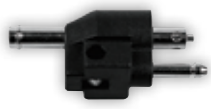

**Fuel Line Tank Female Connector with Ø9,5mm Barb**

Code | 31942



**Fuel Line Tank Female Connector with Ø9,5mm Barb**

Code | 31951



**Fuel Line Tank Male Connector with Ø10mm Barb, Double**

Code | 43324



**Tank Male Connector with 1/4" NPT Barb**

Code | 43322

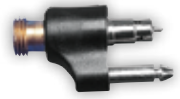

**Suzuki / Chrysler**

**Fuel Line Tank Female Connector with Ø 8mm Barb >60 CV, Chromed Brass**

Code | 31950



**Fuel Line Tank Female Connector with 8mm Barb, Chromed Brass**

Code | 31943



**Fuel Line Tank Male Connector with 1/4" NPT >60 CV, Chromed Brass**

Code | 31946



**Yamaha**

Code | 43314

**Fuel Line Tank Male Connector with Ø8,5mm Barb**



Code | 31942

**Fuel Line Tank Female Connector with Ø9,5mm Barb**



Code | 43322

**Tank Male Connector with 1/4" NPT Barb**



Code | 43324

**Fuel Line Tank Male Connector with Ø10mm Barb, Double**



**Honda**

Code | 43301

**Fuel Line Tank Female Connector with Ø9,5mm Barb**





OMC / Johnson / Evinrude

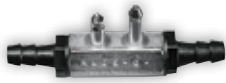

Code | 43333

Fuel Line Tank Male Connector with Ø10mm Barb, Double



Code | 31941

Fuel Line Tank Female Connector with Ø9,5mm Barb



Code | 43331

Fuel Line Tank Male Connector with Ø1/4" NPT Barb



Code | 43329

Fuel Line Tank Male Connector with Ø6,5mm Barb

Tohatsu / Selva



Fuel Line Tank Male Connector with Ø8mm Barb

Code | 31956



Fuel Line Tank Female Connector with Ø8mm Barb

Code | 31952

Fuel Hose



Code	Material	Internal diameter (mm)	External diameter (mm)
37338	PVC fiber reinforced	7	13
37339	PVC	7	13
39311	PVC fiber reinforced	10	16

Plastic Ties, 100pcs



Code	Colour	Length (mm)	Width (mm)	Max diameter (mm)
43816	black	140	3,6	28
43824		200	5	51
43830		360	5	112
43815	white	140	3,6	28
43822		200	5	51
43829		360	5	112

Code	Diameter	
	Internal	External
98551	6mm, 1/4"	16mm
99559	8mm, 5/16"	17mm
98552	10mm, 3/8"	19mm
97592	12mm, 1/2"	22mm
97593	16mm, 5/8"	26mm
97594	19mm, 3/4"	30mm
99005	25mm, 1"	37mm
97601	38mm, 1 1/2"	52mm
97604	51mm, 1 31/32"	64mm

Fuel Delivery Hose Fire Resistant CARBO/7840/A1, Rubber

Tank Vents



Ventilator for Tank



Code	Description	Colour	A (mm)	Hose Ø B (mm)	C (mm)	D (mm)	E (mm)	F (mm)
37331	Straight	White	29	16	83	41	40	-
31515	Elbow 90°	White	29	16	83	41	40	50
37330	Straight	White	29	16	83	60x40	40	-
31517	Elbow 90°	White	29	16	83	60x40	40	50

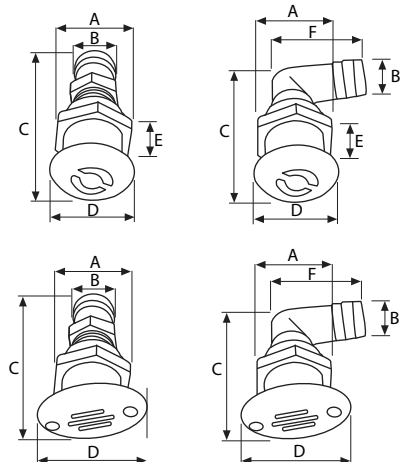

## Tank Vents

Scupper "Space"  
Set, Chromium  
Plated Brass

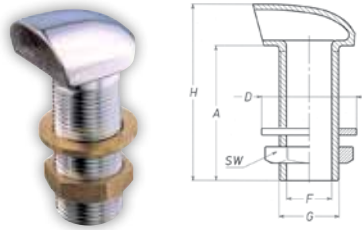

Code	90317	90318	90319	90320	90321	90322
Weight (gr)	160	230	375	550	705	1000
SW (mm)	26	32	38	49	56	68
H (mm)	83	88	98	106	116	124
A (mm)	65	68	75	80	85	90
D (mm)	33	38	48	55	64	77
F (mm)	15	19	25	33	39	50
G (in)	1/2"	3/4"	1"	1 1/4"	1 1/2"	2"



Fuel Tank Vent 5/8"  
I.D. Hose Die Cast  
Zamak, 16cm

Code | 98738



Fuel Tank Vent

Code	Description
98739	Brass chrome plated
98740	Die cast chrome plated



Fuel Tank Vent 90°  
Zamak

Code | 98741



Fuel Tank Vent,  
Round Head 90°

Code	Description
98742	Downward gradient
98743	Upward gradient

## Engine Blowers



Electric Bilge Blower

Code	Voltage (V)	Intensity (A)	Air
94556	12	3	2500
94557	24	1,5	lt/min



Electric, Bilge Blower,  
with Bracket

Code	Voltage (V)	Intensity (A)	Air
94558	12	3	2500
94559	24	1,5	lt/min

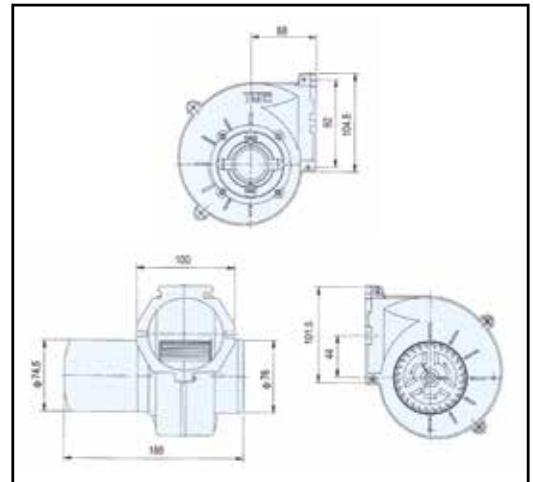

In-line Blower 4"

Code	Volt	Amp.	Air	Dimensions (mm)			
				L	W	H	Ø
91559	12	10	6500	204	152	131	105
91560	24	5	lt/min				

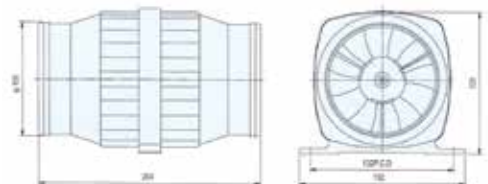



**In-Line Blower 3"**

Code	Volt	Amp.	Air ltr/min	Dimensions (mm)			
				L	W	H	Ø
91557	12	4,5	3452	210	135	111,5	80
91558	24	2,5					

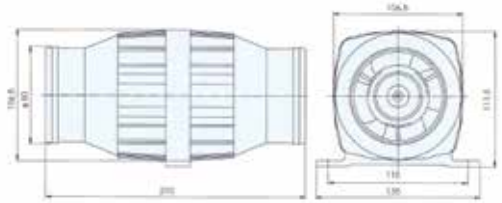

Oil Change Equipment



**Oil Extractor, 4 Liter Capacity**

Code | 99565



**Oil Change Pump, L300mm, Brass Body**

Code | 99128

Exhaust Components

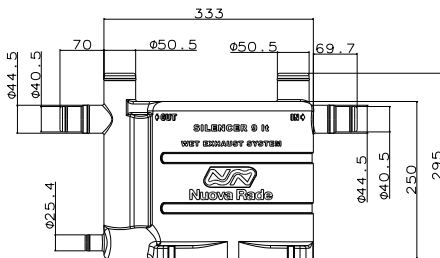

Inlet sizes: 50.5-44.5-40.5mm  
 Outlet sizes: 50.5-44.5-40.5mm  
 Drain size: 25.4mm

Code | 73596

**Boat Waterlock and Exhaust Silencer 9L, Oval, Black**

The Boat Waterlock & Silencer is designed to prevent exhaust water backflow and reduce noise produced by the exhaust to minimum. This heavy-duty waterlock and muffler is recommended for most sailboats and motor yachts with gasoline or diesel engines and water cooled generator sets up to 30HP. Compact design facilitates durable installation with 4 screws x 8mm. It is constructed of high density rotational molded polyethylene which is impervious to corrosion or deterioration from salt water or exhaust from gas. Also, it is resistant to all temperatures normally experienced in water-cooled (wet-type) exhaust systems. With a 25.4 mm drain outlet for system cleaning.



**Neoprene Connection with Inox Flange**

Code	99711	99712	99713
Diameter (mm)	40	50 / 60	75 / 90



**Neoprene Muffler**

Code	For Engines	A* (mm)	B (mm)	C (mm)	D* (mm)
99707	Gasoline up to 40HP & Diesel up to 20HP	60	173	138	49
99708	Gasoline up to 120HP & Diesel up to 50HP	70	268	170	60

\*Internal Diameter

## Drain Plugs

### Drain Socket with Plug



Code	Specifications	Colour	Flange Dimensions (mm)	Overall Height (mm)	Height of Socket (mm)	Cutout Diameter (mm)	Depth Below Deck (mm)	Mini Internal Diameter (mm)
16688	Plain	White	48 x 36	28	19,5	27	15	19
16689	With 2 holes	White						
43462	With captive plug	White	54 x 33	55	25	27	20	19
43463	With captive plug	Black	54 x 33	55	25	27	20	19
95781	With captive plug	White	60x30	52	23	27	18	19
95782	With captive plug	Black	60x30	52	23	27	18	19
43468	With captive plug	White	Ø 40	55	25	27	20	19
43469	With captive plug	Black	Ø 40	55	25	27	20	19
43478	With 4 holes	Black	Ø 43	38	27	25	22	16,5
43477	With 4 holes	White	Ø 43					
16691	With captive plug	White	Ø 46	63	27	28	21	19
16690	Plain	White	Ø 48	76	66	28	62	19
16797	"Fast Lock"	White	Ø 43	107	96	27	91	19



#### Buoyancy Tank Drain Socket, with Captive Plug

Internal diam.: 18 mm  
External diam.: 23 mm

Code | 16687

new



#### Non-return Drain Valve, with Plug for 25mm Transom, Grey, Set

Code | 74449

Code	Colour
45276	White
45277	Black



#### Captive Plug with O-Ring for Drain Socket

Code | 16713



#### Plug for Drain Socket, White

## Windshield Motors & Arms



#### Heavy-duty Marine Wiper Motor, with 1" Shaft, 110°

Code	Volt
98107	12
98108	24

Pin Diameter: Ø14 mm



#### Heavy-duty Wiper Motor, with 2-1/3" Threaded Shaft, Screw-on Type, 83°

Code	Volt
98109	12
98110	24



**Heavy-duty Wiper Motor, 2 Speeds, with 2" Shaft**

Code	Volt	Angle
94548	12	110°



**Water-resistant Wiper Motor**

Code	Volt	Angle
94546	12	90°

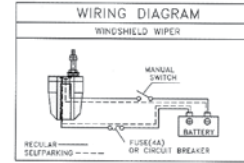
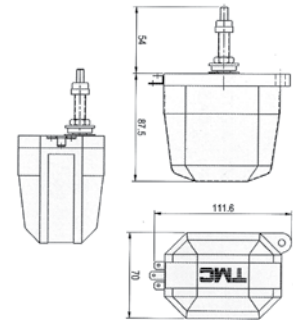

**Marine Wiper Motor, Inox Housing**



Code	Volt	Angle
99811	12	90°

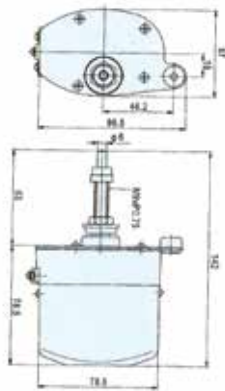

**Wiper Motor**



Code	Volt	Angle
94542	12	90°
94545	24	110°

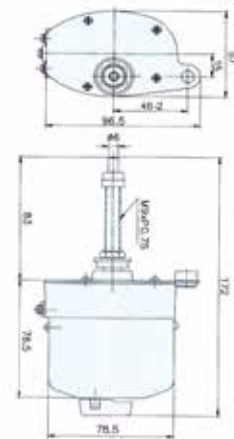

**Adjustable, Single Wire Arm**

Code	Wire arm Length (cm)	Wiper blade Length cm (in.)
98112	27 ~ 36,5	35 (14")
98113	33 ~ 42,5	41 (16")



**Hand Wiper, Arm and Blade, Complete Set**

Code	Length cm (in.)
99805	28 (11")
99806	35 (14")



**Parallel Wiper Arm**

Code	Length cm (in.)
98115	41 (16")



**Wiper Arm**

Code	Description	Length cm (in.)
94530	Inox	28 (11")
94531		35 (14")
94532	Heavy duty Inox	28 (11")
94533	Heavy duty Inox with angle	35 (14")



Boats, Engines & Accessories

## Windshield Motors & Arms



### Wiper Blades

Code	Description	Length cm (in.)
94534	Standard	28 (11")
94535		35 (14")
94536	Heavy duty	28 (11")
94537		35 (14")
94538		41 (16")
94568	Curved wiper blade, black	30,5(12")

		Pairing wiper arm with wiper motor										
Motor \ Arm	Motor	94542	94544	94545	98107	98108	98109	98110	99811	99819	94548	94546
	94530		•	•	•					•	•	
94531		•	•	•					•	•		•
94532					•	•					•	
94533					•	•					•	
98114					•	•					•	
98115						•					•	
98112							•	•				
98113							•	•				

## Marine Horns



### Signal Horn 380ml, Set

Acoustic range approximately 1500 m.

#### Instructions

1. Install horn by screwing it on the pressurised container
  2. To operate press down the horn
  3. Signal horn must always be used in upright position
- Do not store the pressurised container in direct sunlight. Do not expose to temperatures exceeding 40° C. Do not pierce or burn, even after use.

Code | 10033



### Refill Horn Canister, 380ml

Code | 10032



### Fog Horn Head Only

Code | 10031



### Signal Horn ECO 300ml, Set

Code | 72327



### Refill Canister 300ml for Signal Horn ECO 72327

Code | 72903



### Horn, Inox, 12V, 7,6x5cm

Code | 90739



**new**

### Flush mount Electric Horn

It features loud sound and tone, perfect for marine signaling. Ideal for small boats, featuring a very easy installation, with removable front panel, and a perfect fit for installation on steering wheel consoles.



- Electromagnetic type
- Material: White ASA, UV-resistant
- Water-resistant
- Dimensions: 130 x 94 x 49.5 mm
- Drilling Hole: Ø 80mm

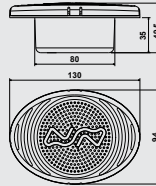

Code	74305
Sound Intensity	>100 dB
Fundamental Frequency	400 Hz
Maximum Amp. draw	1,5 A
Volts	12 V

### Trumpet Electric Horn

It features loud sound and tone, perfect for marine signaling. Ideal for small boats, having easy installation. Available in two colours (white & chrome).

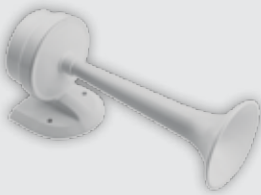

- Electromagnetic type
- High sound output
- Material: ASA, white or chrome plated, UV-resistant
- Water-resistant
- Dimensions: 102 x 223 x 80 mm

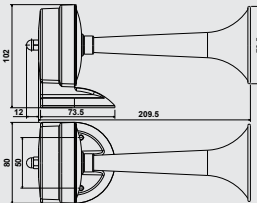

Code	74306	74308
Sound Intensity	>100 dB	
Fundamental Frequency	350 Hz	
Maximum Amp. draw	1,5 A	
Volts	12 V	
Colour	White	Chrome

### Compact Electric Horn

It features loud sound and tone, perfect for marine signaling. Ideal for small & medium boats, with easy installation and modern shape. Available in two colours (white & chrome).



- Electromagnetic type
- Material: ASA, white or chrome plated, UV-resistant
- Water-resistant
- Dimensions: 105 x 92 x 54.5 mm

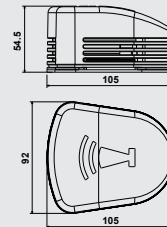

Code	74307	74309
Sound Intensity	>100 dB	
Fundamental Frequency	400 Hz	
Maximum Amp. draw	1,5 A	
Volts	12 V	
Colour	White	Chrome

Boats, Engines & Accessories



### Electric Air Horn

White horn with electric compressor, tubing and mounting hardware.



### Electric Air Horn

White horn with electric compressor, tubing and mounting hardware.

Code	Volts	Maximum Amp. draw	Sound Intensity	Fundamental Frequency	Length	Diameter
71733	24	10	123	315	460mm	200mm

Code	Volts	Maximum Amp. draw	Sound Intensity	Fundamental Frequency	Length	Diameter
71734	12	20	123	315	460mm	200mm
71735	24	10				



## Small Horn

Small electropneumatic horn with high sound output. It comes with a trumpet of white ABS material, electric compressor, tubing, relay and mounting hardware.



Code	Volts	Maximum Amp. draw	Sound Intensity	Fundamental Frequency	Weight (kg)	Length
99154	12	16	116	420	1	25cm
99256	24	8				

## Electric Air Horn

Twin-tone air horn with two plastic chromed trumpets. It comes with electric compressor, tubing, relay and mounting hardware.



Code	Volts	Maximum Amp. draw	Sound Intensity	Fundamental Frequency	Weight (kg)	Length
97942	12	18	111	326/412	1,2	39cm
97943	24	9			1,3	

## Electric Air Horn

Single air horn, entirely manufactured of non-corrosive materials. Plastic chromed trumpet with compressor, tubing, relay and mounting hardware.



Code	Volts	Maximum Amp. draw	Sound Intensity	Fundamental Frequency	Weight (kg)	Length
97938	12	18	114	326	1	39cm
97939	24	9			1,7	

## Electric Air Horn

Air horn with dual sound. It has two metal chromed trumpets and comes with electric compressor, tubing, relay and mounting hardware.



Code	Volts	Maximum Amp. draw	Sound Intensity	Fundamental Frequency	Weight (kg)
97940	12	16	118	692 / 756	1,1
97941	24	8			

## Electric Air Horn

Single electromagnetic horn with stainless steel trumpet, bracket and membrane. New support design with integrated cable. It comes complete with mounting hardware.



Code	Volts	Maximum Amp. draw	Sound Intensity	Fundamental Frequency	Weight (kg)	Length
97946	12	6	119	370	0,9	40cm
97948	24	3				

## Electric Air Horn

Single electromagnetic horn. Acoustic unit carefully protected and manufactured of non-corrosive materials. Entirely chrome plated, complete with mounting hardware.



Code	Volts	Maximum Amp. draw	Sound Intensity	Fundamental Frequency	Weight (kg)
97944	12	5	114	490	0,5



**Sensor for Fuel & Water Tank**  
(12/24V, Inox 316, SAE5)



Code	Use Type	Height (mm)	Impedance (Ohm)	Suitable for
197347	Fuel & Water	150	0 - 190	Sogliola
197348		200		Diablo H230mm Ercole - Bora
197349		250		Ercole
197350		300		Diablo H305mm
197351		350		For custom made tank
197352		400		
197353		450		
197354		500		
197355		600		
197356		150		
197357		200		Diablo H230mm Ercole - Bora
197358		250		Ercole
197359		300		Diablo H305mm
197360		350		For custom made tank
197361	400			
197362	450			
197363	500			
197364	600			



**Sensor for Fresh Water & Waste Tank**  
(12/24V, Inox 316, SAE5)

Code	Use Type	Height (mm)	Impedance (Ohm)	Suitable for
197365	Fresh Water & Waste Water	150	240 - 33	Diablo H230mm - Sogliola
196911		233		Diablo H305mm - Ercole
197367		350		Bora - Blizzard
196909		480		For custom made tank
196910		690		Zefiro 40lt

**Sender for Fuel or Diesel Tank**  
(12/24V, Inox 316, SAE6)



Code	Use Type	Height (mm)	Impedance (Ohm)	Suitable for
197070	Fuel	195	0 - 190	Mistral
197077		233		
197180		272		
197068		293		
197066		315		
197067		330		
197073	Diesel	195	0 - 190	For custom made tank
197075		233		
197076		293		



**Level Gauge**  
12/24V, Ø62mm, Black

Code	Use Type	Impedance (Ohm)	Internal Ø (mm)
197341	Fuel	0 - 190	52
197342		240 - 33	
197343	Water	0 - 190	
197344		240 - 33	
197345	Waste	0 - 190	
197346		240 - 33	

Optimist Accessories

57353



57354



**Optimist Buoyancy Tube with Valve, Grey**

Code	Material	Maximum Air Pressure	Dimensions
57353	PVC	0,5PSI	41x100cm
57354	Nylon with TPU	3,6PSI	

## Optimist Accessories



### Optimist Boat Cover

It protects your Optimist from heavy wear and prolongs its life. Optimist boat cover drapes the entire dinghy and closes tightly for storage. It is made of heavy duty 600D Polyester with PVC backing and ripstop reinforcement to resist in rough weather conditions.

Code | 70174

### Optimist Hiking Straps, L 1,5m W 5cm

Optimist hiking straps hold sailor's feet when hiking and absorb individuals' shocks from rough sailing. Our straps are made of 600D Polyester with PVC backing. They are filled with NBR foam in the middle for water resistance and pleasant feel. The straps are put together on their one edge, so as to adjust them according to the length of your feet. The straps are loose on their other edge to tie them on your Optimist using a plate or buckle.



Code | 70175



### Laser Boat Cover

Code | 71296

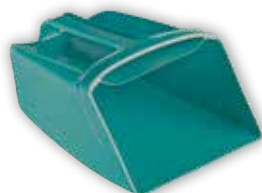

### Bailer Flexible, Floating, Petrol Blue

length 190mm x width 135mm

Code | 16207

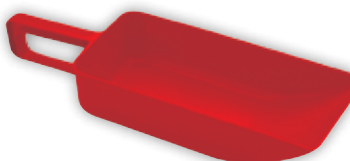

### Bailer Rigid, Red

length 365mm x width 110mm

Code | 44676



### Bailer Rigid, White

length 410mm x width 220mm

Code | 44680



### Bailer Funnel with Filter, Red

length 290mm x width 110mm

Code | 44677



### Bailer Svezia, Red

length 320mm x width 160mm

Code | 44679

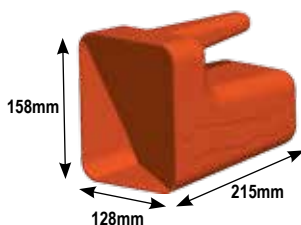

### Bailer for Water Removing, 2,5L, Orange

Code | 11919



### Deck Collar for Optimist, Ø 57mm

Code | 70139

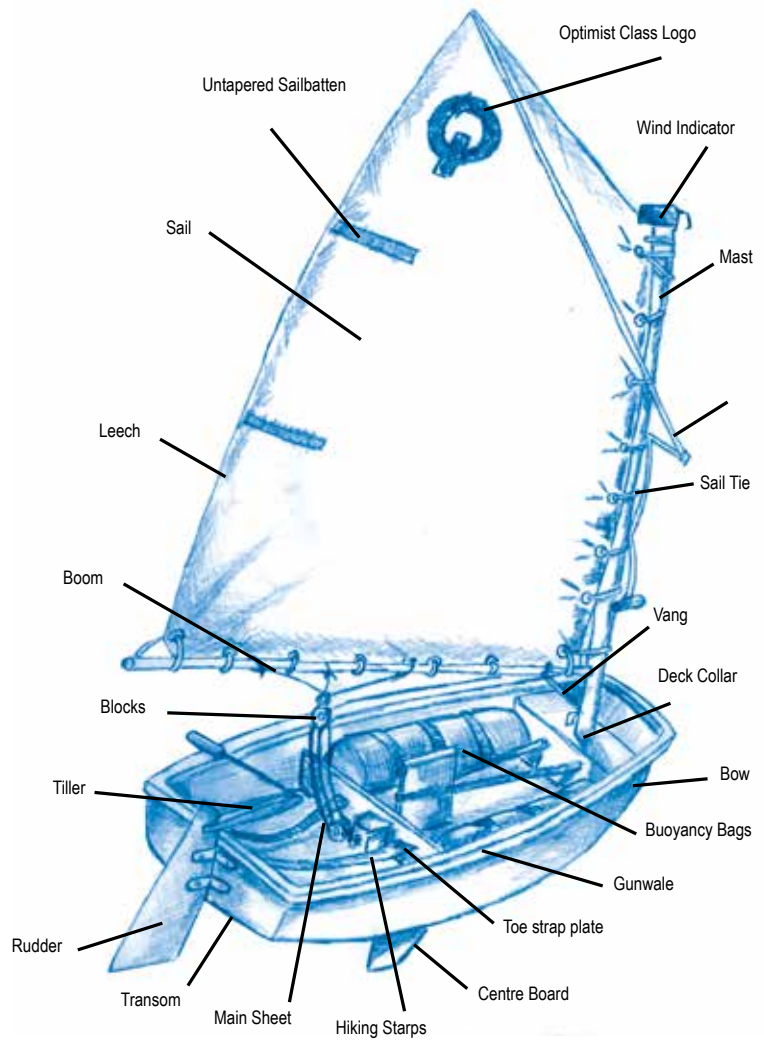

Davits

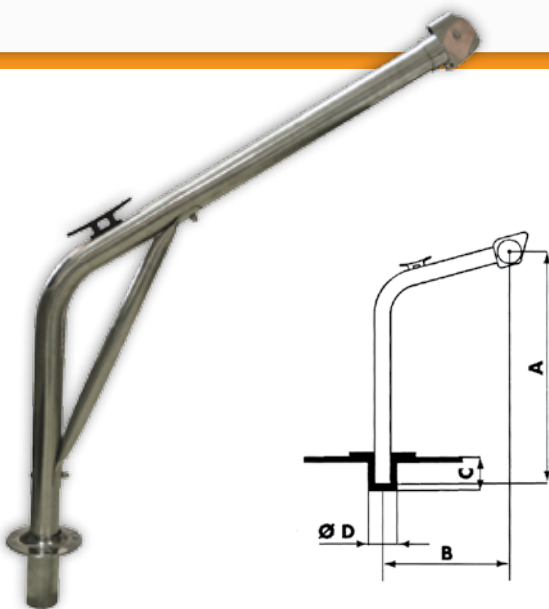

Davits, AISI 316

Code	A (mm)	B (mm)	C (mm)	D (mm)	Tube Diameter (mm)	Lift Weight (kg)
70141	1200	650	120	45	40	60
70142	1200	750	160	64	60	85

## Manual & Electric Winches



Code | 71143



### Electric Winch, AnchorWinch, 12V, 2000lb/1000kg

The AnchorWinch electric trailer winch of 2000lbs capacity features a unique mounting plate which allows you to temporarily or permanently mount it on any flat surface. It also features a built-in carry handle. It is supplied with a 15' (4.5m) power cable, a mounting plate & a hand crank.

#### Technical Characteristics

Magnet Motor: 12V DC, Max 40A, 0,4hp(0,30kw)  
 Pulling Capacity: 2000lbs / 1000kg  
 Line Speed: 6' (1,8m/min) with load  
 Wire Rope (Diam. x L): 0,2" x 30' (5,1mm x 9m)  
 Power Cord: 15' (4,5m) / 9,9'(3m)



### Single Gear Winch, Inox

Code	98750
Capacity (kg)	360



#### Trailer Winch Safety Tips

- Trailer winches are not tie downs. To prevent mishaps, use dedicated bow and stern tie downs to secure your boat on the trailer
- Make sure you have secure footing and proper leverage when using manual winches. Slips and falls by winch operators and injuries from winch handles that kick back are common boat ramp accidents.
- To avoid chafe on the winch line, be sure it doesn't rub against any sharp edges on the winch stand or trailer. If frayed or worn spots appear, replace the winch line immediately with a new rope, strap, or cable of the proper type, size, and strength. Cable life can be extended by frequently lubricating it with wire rope lubricant so the strands of cable slide by each other with less friction. Lubricating your winch cable will also reduce the number of snags and frays in the cable.

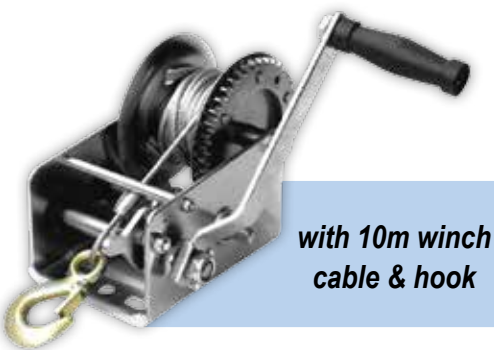

with 10m winch cable & hook

### Trailer Winch, Manual, Single & Double Gear, Carbon Steel, with 10m Winch Cable & Hook

The Seaware winches are made of corrosion-resistant, carbon steel for prolonged life. Our winches feature 3 positions (forward, neutral and reverse), adjusted by their comfortable handle. The various gear ratios reduce user effort and increase pulling efficiency. The capacity of Seaware winches range from 636 to 1135kg.

Code	Capacity	Gear Ratio
11880	1400 lbs / 636kgs	4:1
11881	1800 lbs / 815kgs	4:1
11882	2500 lbs / 1135kgs	4:1 & 8:1



## Trailer Accessories



### Winch Strap

Code	Capacity	Length	Width
72151	2000 kgs	10m	50mm

Pass the pin through the hole of the drum, at the spur gear's side and then through the strap loop (picture 1). Screw the bolt to secure the pin on the drums (picture 2).



There are 2 ways to attach the winch cable on the winch.

**1st way**

Use the cable clamp to attach the edge of the winch cable on the drum.

Boat Position ←



**2nd way**

Follow the arrows to fix the cable on the winch by passing it through the 4 holes on the drum.

Boat Position ←



**Winch Cable with Hook**

Code	Capacity (Kg)	Length	Diameter (mm)
99599	1700	6m	5
99600	1700	10m	5



Carbon Steel

**Ratchet Tie-Down with Double J Hook**

Code	99013	99014	99015
Width (mm)	30	35	50
Length (m)	7	8	10
Breaking Load (kg)	1500	2500	5000



Carbon Steel

**Ratchet Tie-Down with S Hook**

Code	99012
Width (mm)	25
Length (m)	6
Breaking Load (kg)	500



**Tie Down Strap with Self Pad**

Code	99006	99007
Width (mm)	25	25
Length (m)	2,5	4
Breaking Load (kg)	250	250



**Bow Roller, Polymer, Black**

Code	99610	99611
Total Diam. (mm)	70	92
Width (mm)	76	102
Int Diam. (mm)	18	18



**Spool/Keel Roller, Polymer, Black**

Code	99612	99613	99614
Total Diam. (mm)	70	76	83
Width (mm)	102	203	254
Int Diam. (mm)	16	19	16

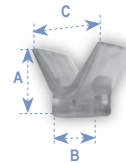

**Bow Stop, Polymer, Black**

Code	99615	99616
A (mm)	76	76
B (mm)	76	76
C (mm)	89	104



**Rubber Bow Roller 6/8" Hole, 1,6cm**

Code | 99090



**Spool Keel Roller Light Duty, Molder Rubber**

Code	99626
Total Diam. (mm)	76
Width (mm)	102
Int Diam. (mm)	16



**Keel Rollers, Molded Rubber**

Code	99091	99092
Length (cm)	20 (8")	25 (10")



**Wobble Roller, Polymer, with Bore, Black**

Code	99617	99620
Total Diam. (mm)	111	108
Width (mm)	76	102
Int Diam. (mm)	20	20

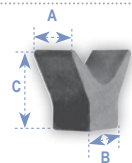

**Bow Stop, Molded Rubber**

Code	99624	99625
A (mm)	51	79
B (mm)	64	76
C (mm)	89	95

## Trailer Accessories

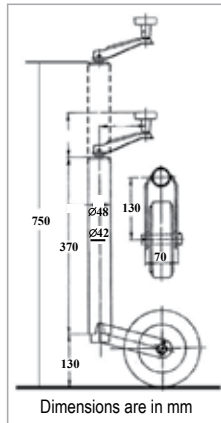

### Jockey Wheel

Made of quality steel and features rubber wheel for maximum support of the frame of the trailer. It can reach up to 750mm max. height, while the min. height is 500mm.

Code	99634
Capacity (kg)	360
Minimum Height (mm)	500
Maximum Height (mm)	750
Wheel dimensions (mm)	200x50



### Spare Wheel For Jockey Wheel, 200x50mm

Code | 90288

Boats, Engines & Accessories

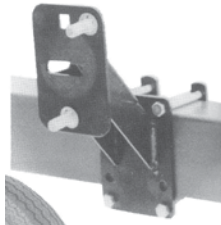

### Mount for Trailer Spare Tire

Code | 99627

## Trailer Lights & Sockets



### Dome Light / Trailer Light, 2 LEDs, Black, 2 pcs

- 77x36x21mm
- 12 & 24V DC, Multivolt
- 2,6W
- 15 lm
- Waterproof

Code | 71237



### Dome Light / Trailer Light, 12 LEDs, Black, 2 pcs

- 104x60x26mm
- 12 & 24V DC, Multivolt
- 2,6W
- 90 lm
- Waterproof

Code | 71235



### Dome Light / Trailer Light, 25 LEDs, Black

- 200x58x30mm
- 12 & 24V DC, Multivolt
- 2,6W
- 187,5 lm
- Waterproof

Code | 71236

### Trailer Light LED Kit with Cable 8m

Code | 72452

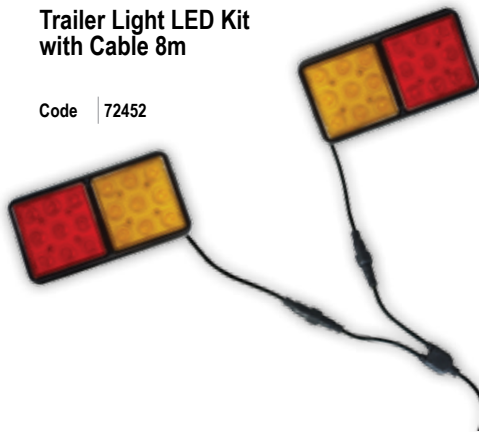

- Overall size: 2pcs - 186x100x27,4mm
- Each trailer light 18LEDs, 9 Amber & 9 Red
- Multi-Working Voltage: 12V & 24V
- Low power consumption
- Longer life
- Easy to install
- Waterproof
- Shockproof
- Vibrationproof
- Rustproof

### LED Trailer Light, Waterproof

- Application: Stop / Tail / Indicator Light
- Multi-Working Voltage: 12V & 24V
- Low Power Consumption
- Longer Life
- Easy to Install
- Waterproof
- Shockproof
- Vibration proof
- Rustproof



Code	90006	90007
Description	Double	Single
Dimensions (mm)	190x100x28	100x100x28



### Trailer Plug Male, 7-pin, for 11887 Plug

Code | 99605



### Trailer Plug Female, Fixed, 7-pin

Code | 11887





# Deck Equipment



Besides from the must-have equipment that is needed for a boat, there are also some other accessories that could be useful while your boat is at sea or anchored.

For your convenience, MARINA Stores offer deck hardware accessories, such as deck plates & hatches, bugbusters, rail hardware, locks & hooks, hinges, handrail, screws, nuts & washers, flags & accessories. In this category you can also find high-quality boat covers, canopies or bimini tops in order to protect your boat and your outboard engine from heavy weather conditions and high temperatures.

All products are made of premium materials for high durability and resistance to the marine environment.

Deck Hatches	174-188	Handles & Handrails	215-216
Inspection Hatches	188-190	Screws, Nuts & Washers	216-218
Storage Hatches	190-191	Pilot Seats & Pedestals	218-220
Portlights - Escape Hatches	191-194	Buoyant Deck Cushions	220
Hatch Accessories	195	Tables & Pedestals	220-221
Deck Fillers	195-197	Deck Chairs & Tables	221
Ventilation Systems	198	Bimini Tops & Shades	222-224
Utility Cases	198-204	Bimini Hardware	225-227
Pad Eyes	205-206	Tarpaulin Covers	228
Shackles	206-208	Boat & Engines Covers	228-230
U-Bolts & Cleats	208-209	Cover Support	230
Hinges	210-211	Welcome Mats & Carpets	231
Rails Hardware	212-213	Flags & Accessories	231-232
Locks / Door Hooks / Barrel Bolts	214-215		

# Deck Hatches

**Krome**

353x606mm  
315x440mm  
270x375mm

243x607mm  
370x375mm  
460x525mm

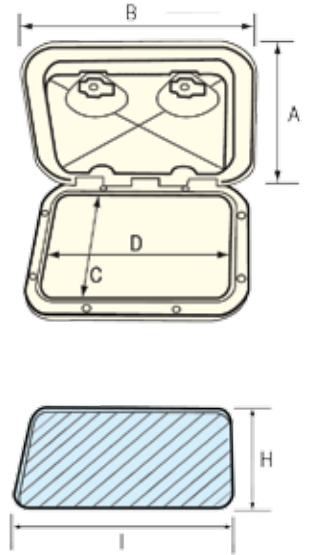
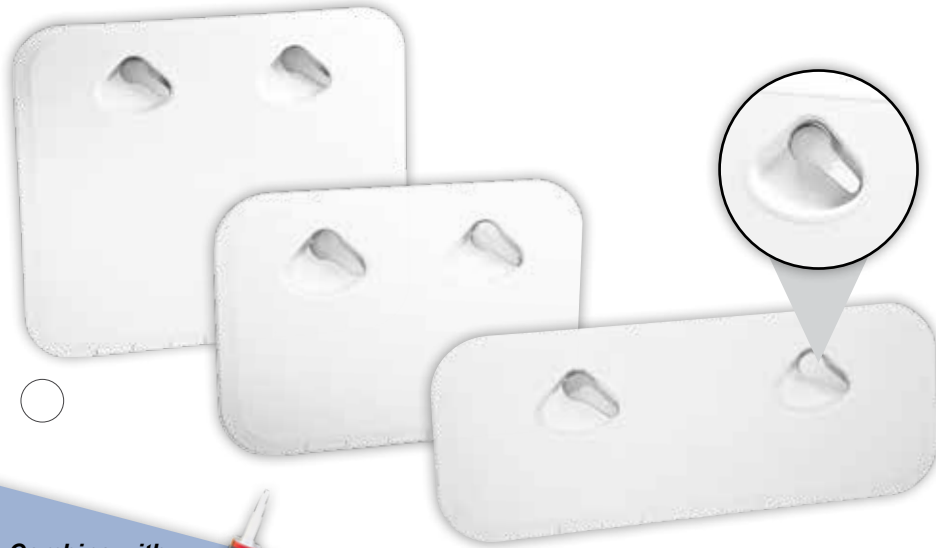

Deck Equipment

Combine with  
Polyurethanes  
page 394



**KROME Hatch**

- With chromed handles
- UV-resistant high-grade ASA

Code	Colour	A (mm)	B (mm)	C (mm)	D (mm)	H (mm)	I (mm)	Optional Spare Parts		
								Lock	Handle	Gasket
196513	White	270	375	193	293	200	300			
196514		315	440	237	357	243	363			
196515		353	606	274	520	283	530			
196516		243	607	162	521	173	530			
196517		370	375	292	292	300	300			
196518		460	525	382	433	390	445			

## 270x375mm



**TOP LINE Hatch**

UV-resistant high-grade ASA

Code	Model	Colour	Optional Spare Parts		
			Lock	Handle	Gasket
196279*	Standard	White			
196293		Grey			
196286		Cream			
197267		Black			
196280	With lock	White	44813	44206 (White) 44207 (Grey) 47738 (Cream) 198133 (Black)	44554 (1,7m)
196294		Grey			
196287		Cream			

○ ● \* CE ISO 12216

Combine with  
Screws  
page 216-217



A (mm)	B (mm)	C (mm)	D (mm)	H (mm)	I (mm)
270	375	193	293	200	300

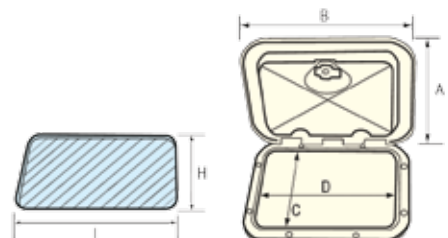





**Top Line**

**TOP LINE Storage Hatch**  
UV-resistant high-grade ASA

270x375mm

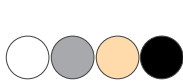

A (mm)	B (mm)	C (mm)	D (mm)	E (mm)	F (mm)	G (mm)	H (mm)	I (mm)
270	375	193	293	270	170	160	210	305

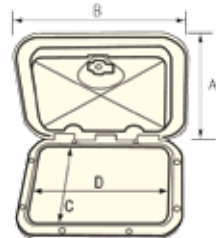
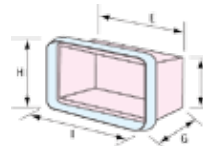

Code	Model	Colour	Optional Spare Parts		
			Lock	Handle	Gasket
196281	Standard	White			
196295		Grey			
196288		Cream			
198055		Black			
196282	With lock	White	44813	44206 (White) 44207 (Grey) 47738 (Cream) 198133 (Black)	44554 (1,7m)

**TOP LINE Storage Hatch with Drawers**  
UV-resistant high-grade ASA



A (mm)	B (mm)	C (mm)	D (mm)	E (mm)	F (mm)	G (mm)	H (mm)	I (mm)
270	375	193	293	270	170	160	210	305

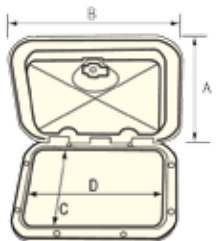
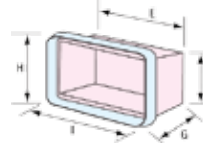

Code	Model	Colour	Optional Spare Parts		
			Lock	Handle	Gasket
196283	Standard	White			
196297		Grey			
196290		Cream			
196284	With lock	White	44813	44206 (White) 44207 (Grey) 47738 (Cream)	44554 (1,7m)

315x440mm



A (mm)	B (mm)	C (mm)	D (mm)	H (mm)	I (mm)
315	440	237	357	243	363

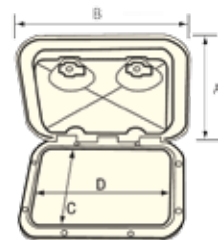
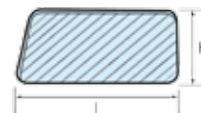

**TOP LINE Hatch**  
UV-resistant high-grade ASA

Code	Model	Colour	Optional Spare Parts		
			Lock	Handle	Gasket
196300*	Standard	White			
196306*		Grey			
196303*		Cream			
198017*		Black			
196301	With lock	White	44813	44206 (White) 44207 (Grey) 47738 (Cream)	44554 (1,7m)

\* CE ISO 12216

Deck Equipment

**Top Line**



**353x606mm**



**TOP LINE Hatch**  
UV-resistant high-grade ASA

Code	Model	Colour	Optional Spare Parts		
			Lock	Handle	Gasket
196256*	Standard	White			
196317*		Grey			
196312*		Cream			
197294*		Black			
196309	With lock	White	44813	44206 (White) 44207 (Grey) 47738 (Cream) 198133 (Black)	44554 (1,7m)
196318		Grey			
196313		Cream			



A (mm)	B (mm)	C (mm)	D (mm)	H (mm)	I (mm)
353	606	275	520	283	530

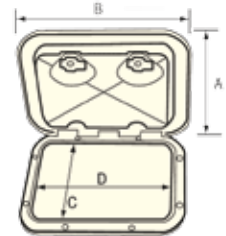
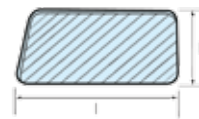

Deck Equipment

**Combine with**  
Polyurethanes  
page 394



**TOP LINE Storage Hatch**  
UV-resistant high-grade ASA

Code	Model	Colour	Optional Spare Parts		
			Lock	Handle	Gasket
196310	Standard	White			
196314		Cream			
198065		Black			
196311	With lock	White	44813	44206 (White) 47738 (Cream) 198133 (Black)	44554 (1,7m)
196315		Cream			



A (mm)	B (mm)	C (mm)	D (mm)	E (mm)	F (mm)	G (mm)	H (mm)	I (mm)
353	606	275	520	495	250	325	290	540

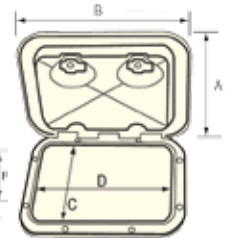
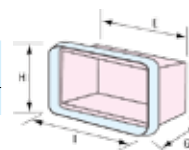

**243x607mm**



**TOP LINE Hatch**  
UV-resistant high-grade ASA

Code	Model	Colour	Optional Spare Parts		
			Lock	Handle	Gasket
196322*	Standard	White			
196328*		Grey			
196325*		Cream			
198020*		Black			
196323	With lock	White	44813	44206 (White) 44207 (Grey) 47738 (Cream) 198133 (Black)	44554 (1,7m)



A (mm)	B (mm)	C (mm)	D (mm)	H (mm)	I (mm)
243	607	162	521	173	530

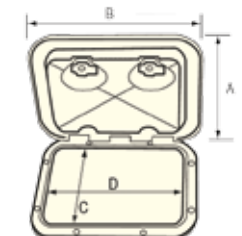
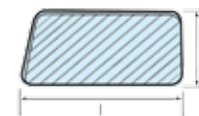



**243x607mm**



Combine with  
Screws  
page 216-217



A (mm)	B (mm)	C (mm)	D (mm)	E (mm)	F (mm)	G (mm)	H (mm)	I (mm)
243	607	162	521	505	151	194	177	535

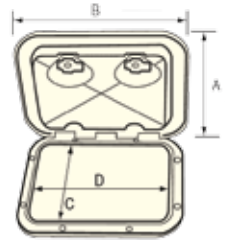
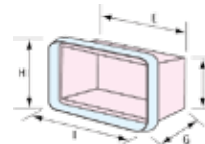

**TOP LINE Storage Hatch**  
UV-resistant high-grade ASA

Code	Model	Colour	Optional Spare Parts		
			Lock	Handle	Gasket
196657	Standard	White			
196661		Grey			
196659		Cream			
196658	With lock	White	44813	44206 (White) 44207 (Grey) 47738 (Cream)	44554 (1,7m)



Deck Equipment

**new 272x657mm**



A (mm)	B (mm)	C (mm)	D (mm)	H (mm)	I (mm)
272	657	570	192	201	580

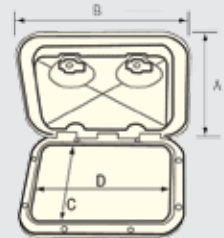
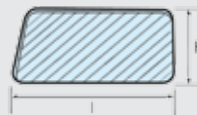

**TOP LINE Hatch**  
UV-resistant high-grade ASA

Code	Model	Colour	Optional Spare Parts		
			Lock	Handle	Gasket
198151	Standard	White	 44813	 44206 (White)	 44554 (1,7m)

**370x375mm**



\* CE ISO 12216



A (mm)	B (mm)	C (mm)	D (mm)	H (mm)	I (mm)
370	375	293	293	295	295

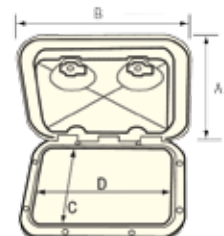
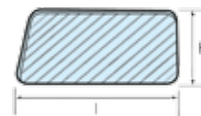

**TOP LINE Hatch**  
UV-resistant high-grade ASA

Code	Model	Colour	Optional Spare Parts		
			Lock	Handle	Gasket
196331*	Standard	White			
196341*		Grey			
196336*		Cream			
198018*		Black			
196332	With lock	White	44813	44206 (White) 44207 (Grey) 47738 (Cream) 198133 (Black)	44554 (1,7m)

**Top Line**



**370x375mm**



**TOP LINE Storage Hatch**

UV-resistant high-grade ASA

Code	Model	Colour	Optional Spare Parts		
			Lock	Handle	Gasket
196333	Standard	White			
196343		Grey			
196338		Cream			
196334	With lock	White	44813	44206 (White) 44207 (Grey) 47738 (Cream)	44554 (1,7m)
196344		Grey			
196339		Cream			

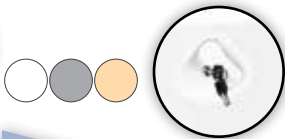

A (mm)	B (mm)	C (mm)	D (mm)	E (mm)	F (mm)	G (mm)	H (mm)	I (mm)
370	375	293	293	308	308	256	305	305

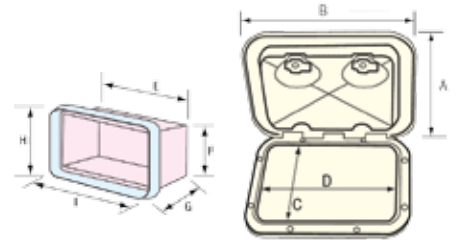

Deck Equipment

**Combine with**

Polyurethanes  
page 394



**460x525mm**



**TOP LINE Hatch**

UV-resistant high-grade ASA

Code	Model	Colour	Optional Spare Parts		
			Lock	Handle	Gasket
196346*	Standard	White			
196356		Grey			
196351		Cream			
198019		Black			
196347	With lock	White	44813	44206 (White) 44207 (Grey) 47738 (Cream) 198133 (Black)	44554 (1,7m)
196357		Grey			
196352		Cream			

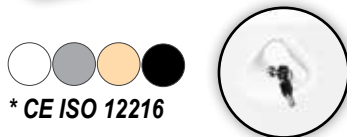

\* CE ISO 12216

A (mm)	B (mm)	C (mm)	D (mm)	H (mm)	I (mm)
460	525	382	433	390	445

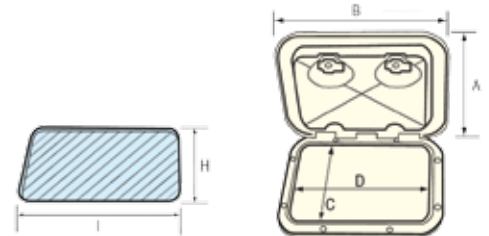

**TOP LINE Storage Hatch**

UV-resistant high-grade ASA



Code	Model	Colour	Optional Spare Parts		
			Lock	Handle	Gasket
196348	Standard	White			
198066		Black			
196349	With lock	White	44813	44206 (White) 198133 (Black)	44554 (1,7m)



A (mm)	B (mm)	C (mm)	D (mm)	E (mm)	F (mm)	G (mm)	H (mm)	I (mm)
460	525	382	433	410	350	330	395	445

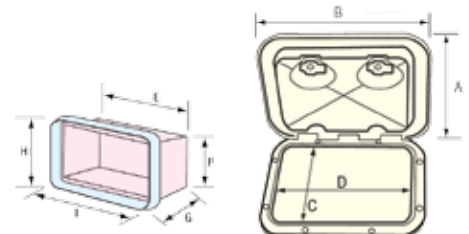

**Top Line**



**370x390mm**

**TOP LINE Storage Hatch for Gas Bottle 3kg**  
UV-resistant high-grade ASA



Supplied with fixing strap (43895) for the gas bottle



To be installed as per DIR 24/25 EC ANNEX 1 PAR

Code	Model	Colour	Optional Spare Parts			
			Lock	Handle	Gasket	Strap
196257	Interrupted gasket	White				
196258		Cream				
196259	Whole gasket	White	44813	44206 (White) 47738 (Cream)	44554 (1,7m)	43895 (1,3m)

A (mm)	B (mm)	C (mm)	D (mm)	E (mm)	F (mm)	G (mm)	H (mm)	I (mm)
370	390	289	323	330	300	270	305	338

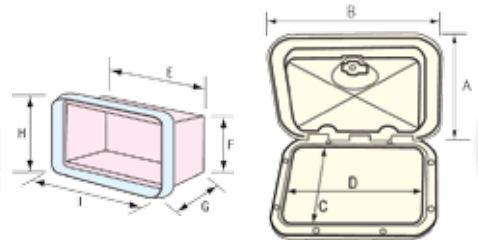

Code | 43895  **Strap Fixing, L.1,30m**

**Door for TOP LINE Storage Gas Container**  
UV-resistant high-grade ASA



Code	Model	Colour	Optional Spare Parts		
			Lock	Handle	Gasket
196845	Interrupted gasket	White			
			44813	44206 (White)	44554 (1,7m)

A (mm)	B (mm)	C (mm)	D (mm)	H (mm)	I (mm)
370	390	289	323	305	338



**Mid Line**

**355x600mm**

**MID LINE Hatch**  
UV-resistant high-grade ASA



Code	Model	Colour	Optional Spare Parts		
			Lock	Handle	Gasket
196849	Standard	White			
196852	With lock	White	44813	44206 (White)	44554 (1,7m)

A (mm)	B (mm)	C (mm)	D (mm)	H (mm)	I (mm)
355	600	250	500	282	529

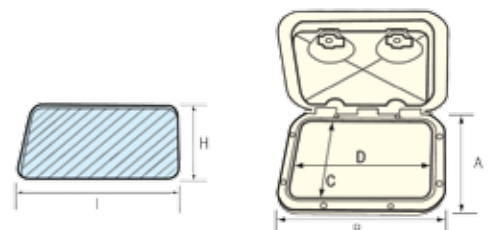

**Combine with**  
Screws  
page 216-217

Deck Equipment

# Deck Hatches

## Mid Line

355x600mm



A (mm)	B (mm)	C (mm)	D (mm)	E (mm)	F (mm)	G (mm)	H (mm)	I (mm)
355	600	250	500	520	280	320	285	535

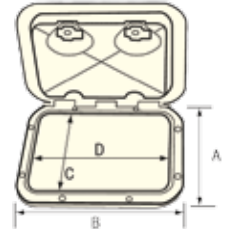
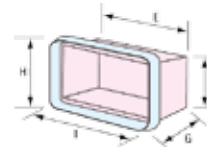

### MID LINE Storage Hatch

UV-resistant high-grade ASA

Code	Model	Colour	Optional Spare Parts		
			Lock	Handle	Gasket
196855	Standard	White			
196858	With lock	White	44813	44206 (White)	44554 (1,7m)



Deck Equipment

278x378mm



A (mm)	B (mm)	C (mm)	D (mm)	H (mm)	I (mm)
278	378	175	275	198	296

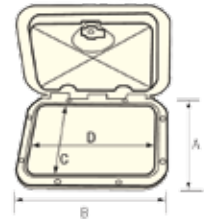
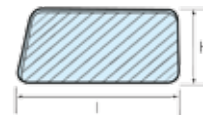

### MID LINE Hatch

UV-resistant high-grade ASA

Code	Model	Colour	Optional Spare Parts		
			Lock	Handle	Gasket
196812	Standard	White			
196815	With lock	White	44813	44206 (White)	44554 (1,7m)

#### Combine with

Polyurethanes  
page 394



### MID LINE Storage Hatch

UV-resistant high-grade ASA

Code	Model	Colour	Optional Spare Parts		
			Lock	Handle	Gasket
196818	Standard	White			
196821	With lock	White	44813	44206 (White)	44554 (1,7m)

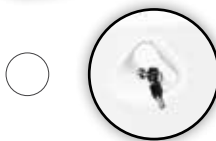

A (mm)	B (mm)	C (mm)	D (mm)	E (mm)	F (mm)	G (mm)	H (mm)	I (mm)
278	378	175	275	270	170	160	210	305

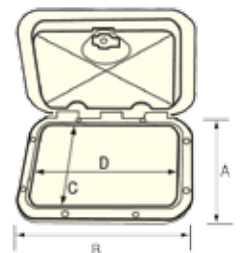
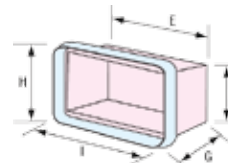



**Mid Line**

**278x378mm**



**MID LINE Storage Hatch with Drawers**  
UV-resistant high-grade ASA

Code	Model	Colour	Optional Spare Parts		
			Lock	Handle	Gasket
196824	Standard	White			
196827	With lock	White	44813	44206 (White)	44554 (1,7m)

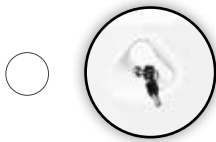

A (mm)	B (mm)	C (mm)	D (mm)	E (mm)	F (mm)	G (mm)	H (mm)	I (mm)
278	378	175	275	270	170	160	210	305

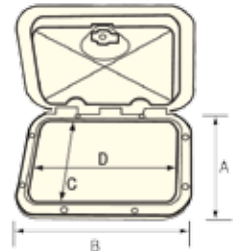
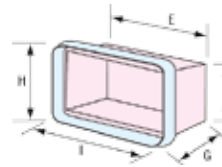

Deck Equipment

**380x380mm**



**MID LINE Hatch**  
UV-resistant high-grade ASA

Code	Model	Colour	Optional Spare Parts		
			Lock	Handle	Gasket
196833	Standard	White			
196836	With lock	White	44813	44206 (White)	44554 (1,7m)

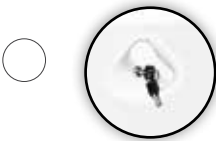

A (mm)	B (mm)	C (mm)	D (mm)	H (mm)	I (mm)
380	380	275	275	298	298

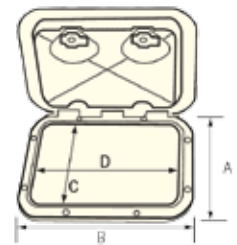
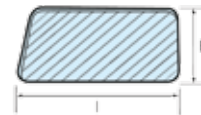

**Combine with**  
Screws  
page 216-217



**MID LINE Storage Hatch**  
UV-resistant high-grade ASA

Code	Model	Colour	Optional Spare Parts		
			Lock	Handle	Gasket
196839	Standard	White			
196842	With lock	White	44813	44206 (White)	44554 (1,7m)

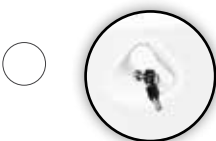

A (mm)	B (mm)	C (mm)	D (mm)	E (mm)	F (mm)	G (mm)	H (mm)	I (mm)
380	380	275	275	280	280	250	315	315

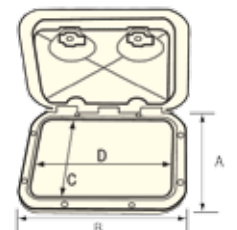
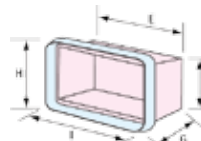

**Classic**

**275x375mm**



**CLASSIC Hatch**

UV-resistant high-grade ASA



Code	Model	Colour	Optional Spare Parts		
			Lock	Handle	Gasket
196567	Standard	White			
196577		Grey			
196586		Cream			
196569	With lock	White	44813	44206 (White) 44207 (Grey) 47738 (Cream)	44554 (1,7m)

A (mm)	B (mm)	C (mm)	D (mm)	H (mm)	I (mm)
275	375	180	280	198	298

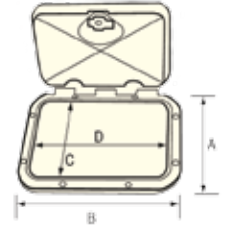
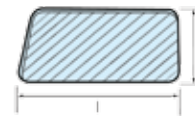

Deck Equipment



**CLASSIC Storage Hatch**

UV-resistant high-grade ASA

Code	Model	Colour	Optional Spare Parts		
			Lock	Handle	Gasket
196570	Standard	White			
196571	With lock	White			
			44813	44206 (White)	44554 (1,7m)

A (mm)	B (mm)	C (mm)	D (mm)	E (mm)	F (mm)	G (mm)	H (mm)	I (mm)
275	375	180	280	270	170	160	210	305

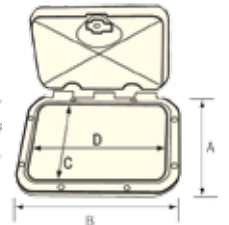
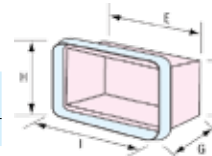

**CLASSIC Storage Hatch with Drawers**

UV-resistant high-grade ASA

Code	Model	Colour	Optional Spare Parts		
			Lock	Handle	Gasket
196572	Standard	White			
196573	With lock	White			
			44813	44206 (White)	44554 (1,7m)

A (mm)	B (mm)	C (mm)	D (mm)	E (mm)	F (mm)	G (mm)	H (mm)	I (mm)
275	375	180	280	270	170	160	210	305

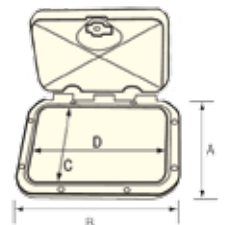
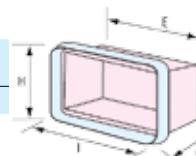

Supplied with screw hole covers





275x375mm



A (mm)	B (mm)	C (mm)	D (mm)	G (mm)	H (mm)	I (mm)
275	375	180	280	220	198	298

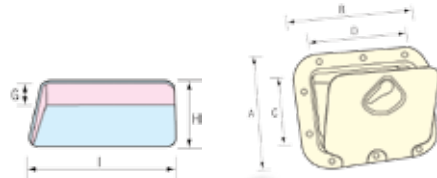

**CLASSIC Hatch with Storage Bag**  
UV-resistant high-grade ASA

Code	Model	Colour	Optional Spare Parts		
			Lock	Handle	Gasket
196574	Standard	White			
196575	With lock	White	44813	44206 (White)	44554 (1,7m)

Combine with  
Screws  
page 216-217

355x600mm



A (mm)	B (mm)	C (mm)	D (mm)	H (mm)	I (mm)
355	600	255	500	275	529

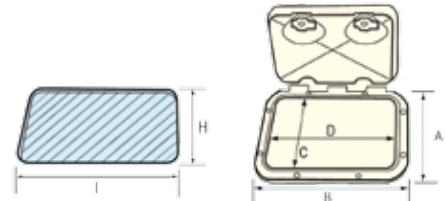

**CLASSIC Hatch**  
UV-resistant high-grade ASA

Code	Model	Colour	Optional Spare Parts		
			Lock	Handle	Gasket
196596	Standard	White			
196604		Grey			
196598	With lock	White	44813	44206 (White) 44207 (Grey)	44554 (1,7m)

**CLASSIC Storage Hatch**  
UV-resistant high-grade ASA



A (mm)	B (mm)	C (mm)	D (mm)	E (mm)	F (mm)	G (mm)	H (mm)	I (mm)
355	600	255	500	495	245	291	280	535

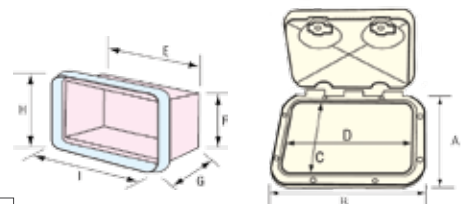

Combine with

Polyurethanes  
page 394



Supplied with screw hole covers

Deck Equipment

**Classic**



**355x600mm**



**CLASSIC Hatch with Storage Bag**  
UV-resistant high-grade ASA

Code	Model	Colour	Optional Spare Parts		
			Lock	Handle	Gasket
196601	Standard	White			
196602	With lock	White	44813	44206 (White)	44554 (1,7m)

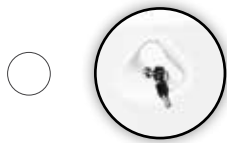

A (mm)	B (mm)	C (mm)	D (mm)	G (mm)	H (mm)	I (mm)
355	600	250	500	220	275	524

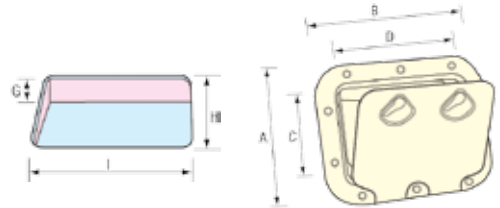

Deck Equipment

**463x517mm**



**CLASSIC Hatch**  
UV-resistant high-grade ASA

Code	Model	Colour	Optional Spare Parts		
			Lock	Handle	Gasket
196619	Standard	White			
196626		Grey			
196633		Cream			
196620	With lock	White	44813	44206 (White) 44207 (Grey) 47738 (Cream)	44554 (1,7m)



A (mm)	B (mm)	C (mm)	D (mm)	H (mm)	I (mm)
463	517	362	416	386	442

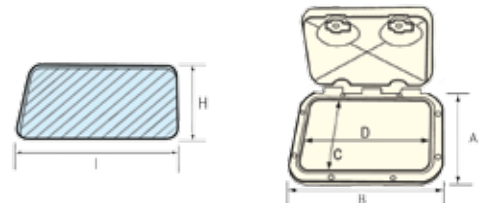

**Combine with**  
Polyurethanes  
page 394



**CLASSIC Storage Hatch**  
UV-resistant high-grade ASA

Code	Model	Colour	Optional Spare Parts		
			Lock	Handle	Gasket
196621	Standard	White			
196622	With lock	White	44813	44206 (White)	44554 (1,7m)



A (mm)	B (mm)	C (mm)	D (mm)	E (mm)	F (mm)	G (mm)	H (mm)	I (mm)
463	517	362	416	410	350	290	395	445



Supplied with screw hole covers

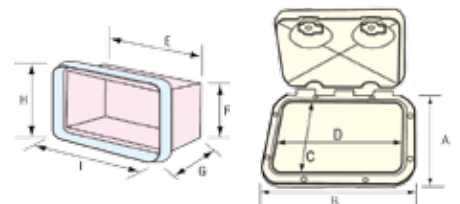



**463x517mm**



**CLASSIC Hatch with Storage Bag**  
UV-resistant high-grade ASA

Code	Model	Colour	Optional Spare Parts		
			Lock	Handle	Gasket
196623	Standard	White			
196624	With lock	White	44813	44206 (White)	44554 (1,7m)

A (mm)	B (mm)	C (mm)	D (mm)	G (mm)	H (mm)	I (mm)
463	517	362	416	220	386	442

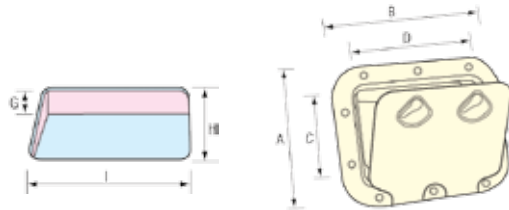

Deck Equipment

**275x375mm**



**CLASSIC Hatch with Removable Cover**  
UV-resistant high-grade ASA

Code	Model	Colour	Optional Spare Parts		
			Lock	Handle	Gasket
196568	Standard	White			
			44813	44206 (White)	44554 (1,7m)

A (mm)	B (mm)	C (mm)	D (mm)	H (mm)	I (mm)
275	375	180	280	198	298

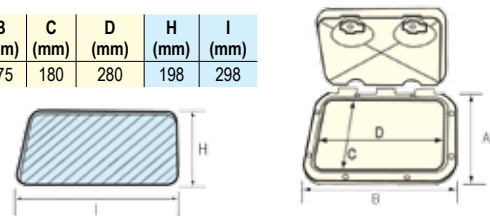

**Combine with**  
Screws  
page 216-217



**355x600mm**



**CLASSIC Hatch with Removable Cover**  
UV-resistant high-grade ASA

Code	Model	Colour	Optional Spare Parts		
			Lock	Handle	Gasket
196597	Standard	White			
196612		Cream	44813	44206 (White) 47738 (Cream)	44554 (1,7m)

A (mm)	B (mm)	C (mm)	D (mm)	H (mm)	I (mm)
355	600	259	506	282	530

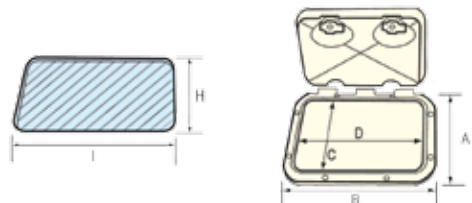

Supplied with screw hole covers

### INDUSTRIAL Access and Inspection Hatch

The Access and Inspection Hatches are ideal for easily reaching and controlling various areas on board, such as fuel lines, electrical cables, gauges, controls, even the engine. They are specially designed with a non-skid surface and can be mounted both horizontally, as well as vertically. All hatches are mounted with hidden screws for discrete appearance. They feature a seal that makes the hatch water-resistant and a 180° opening door, with one or two handles, where you can install a lock. All hatches are made of tough, UV-resistant PP (polypropylene), impervious to chemical solvents, and are designed for external use.

**270x370mm 250x598mm 358x600mm 460x511mm**

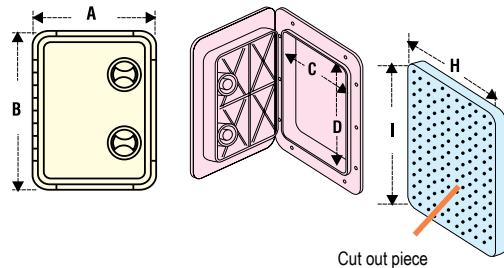

#### INDUSTRIAL Access Hatch

UV-resistant PP (polypropylene)

Code	Model	Colour	A (mm)	B (mm)	C (mm)	D (mm)	H (mm)	I (mm)	Optional Spare Parts	
									Lock	Gasket
10262	Standard	White	270	370	193	293	200	300		
10263		Grey								
11103		White								
11104		Grey								
10264		White								
10265		Grey								
11101		White								
11102		Grey								

**Combine with**  
Polyurethanes  
page 394



**Internal Ø201mm Ø254mm**

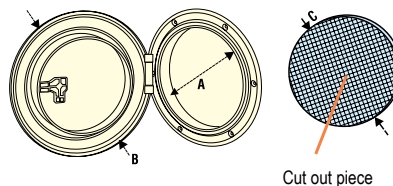

#### INDUSTRIAL Inspection Hatch

UV-resistant PP (polypropylene)

Code	Model	Colour	A (mm)	B (mm)	C (mm)	Optional Spare Parts	
						Lock	Gasket
10266	Standard	White	201	280	208		
10268		Grey					
10270		White					
10272		Grey					

**Combine with**  
Screws  
page 216-217



### INDUSTRIAL Access Hatch with Detachable Cover

The Access Hatches with Detachable Covers are made of tough UV-resistant PP (polypropylene), impervious to chemical solvents, and are ideal for both internal and external use. They feature a completely detachable door for ease of use, handles, that can be fitted with a lock, and a sealed gasket. The non-skid surface and the hidden screws are additional important features. Available in white and grey colour.



**316x360mm**

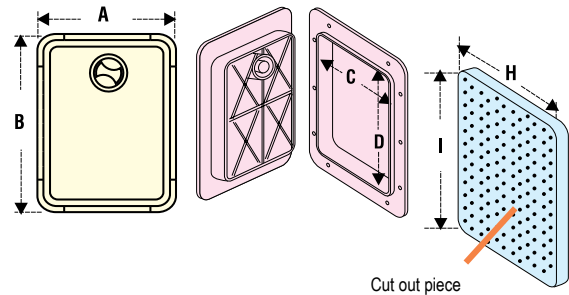



Deck Equipment

### INDUSTRIAL Access Hatch with Detachable Cover

UV-resistant PP (polypropylene)



Code	Model	Colour	A (mm)	B (mm)	C (mm)	D (mm)	H (mm)	I (mm)	Optional Spare Parts	
									Lock	Gasket
11105	Standard	White	316	360	226	276	250	300		
11106		Grey								

### INSPECTION Hatches with Detachable Cover

The Inspection Hatches with Detachable Cover are made of tough UV-resistant PP (polypropylene) for extra resistance to the sun, water, salt and detergents containing acetone. They have no hinges, so that you can completely remove the cover. Their opening is easy, since the specially designed thread automatically ejects the cover, once you turn it 90° counter clockwise. Furthermore, they feature non-skid surface and hidden screws for smarter appearance.

**Internal Ø100mm Ø132mm Ø155mm**



### INDUSTRIAL Inspection Hatch with Detachable Cover

UV-resistant PP (polypropylene)

Code	Colour	A (mm)	B (mm)	C (mm)
11107	White	100	154	113,5
11109		132	181	141
11111		155	210	164

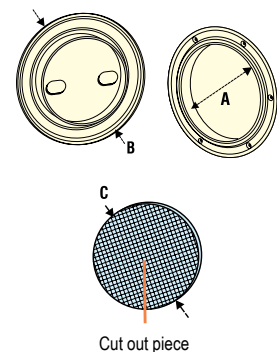

## Installing the key lock on the Nuova Rade hatches

### Parts



1. Remove the screw (A), the tongue (B), and the fastener (C) from the back side of the key lock (D).



2. Drill a 12mm hole in the specified mark at the back of the handle.

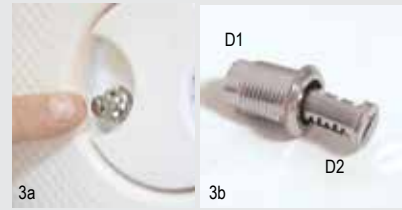

3. Insert the lock into the tube from the front side of the hatch (Pic 3a). Attention: The lock is made of 2 pieces, the tube (D1) and the locking mechanism (D2) (Pic 3b). Since these are not attached together, you must be careful in handling, so that you do not lose the latter during installation.



4. Holding the lock in place with one hand, place the fastener from the back side of the hatch, with the other. Fasten till the end.



5. Place the tongue from the back side of the hatch



6. Fasten the screw from the back side of the hatch

### Attention

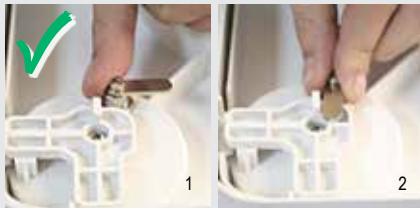

When placing the tongue make sure that the handle is in the lock position and that the tongue is facing towards the centre of the hatch's locking system. These are the correct open (pic 1) and close (pic 2) positions.

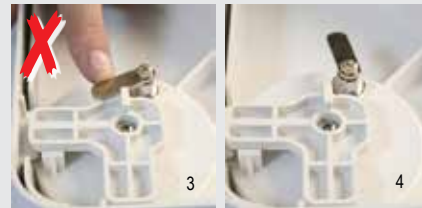

If you place the tongue any other way it will not lock firmly (see pictures 3 & 4).

## Inspection Hatches



Combine with  
Polyurethanes  
page 394



### Inspection Hatch UV-resistant high-grade ASA

Code	Model	Colour	A (mm)	B (mm)	C (mm)	D (mm)	Optional Spare Parts		
							Lock	Handle	Gasket
42791	Standard	White	185	265	219	205			
47726		Cream							
46580		Grey							
43565		White	235	315	265	250			
47725		Cream							
46579		Grey							

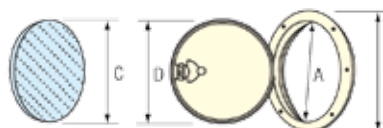



## Inspection Hatch with Removable Cover

UV-resistant high-grade ASA



Code	Model	Colour	A (mm)	B (mm)	C (mm)	D (mm)	H (mm)	I (mm)	Optional Spare Parts		
									Lock	Handle	Gasket
45163	Standard	White	306	356	246	296	255	302			
45164		Grey									
45166	Standard	White	380	380	316	316	325	325	44810	44197 (White) 44198 (Grey) 47737 (Cream)	44556 (1,5m)
45175		White									
45176	With lock	Grey	380	380	316	316	325	325	44810	44197 (White) 44198 (Grey) 47737 (Cream)	44556 (1,5m)
45178		White									

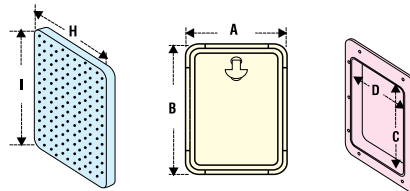

## Inspection Hatch

UV-resistant high-grade ASA



Code	Colour	A (mm)	B (mm)	C (mm)	Optional Spare Key
195380	White	100	139	114	
195381*		125	164	139	
195382*		150	205	165	

**Spare Key for Inspection Hatch**

Code | 196053

196053

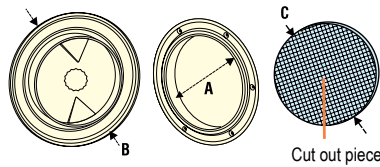

\* CE ISO 12216

**Combine with**  
Screws  
page 216-217

## Inspection Hatch

UV-resistant high-grade ASA  
Rotating lock and bayonet with O-Ring



Code	Colour	A (mm)	B (mm)	C (mm)
43909	White	104	143	115
43910	Black			
47731	Cream	130	170	142
43918	White			
43919	Black	155	200	168
47732	Cream			
43927	White	168	222	180
43928	Black			
47733	Cream			

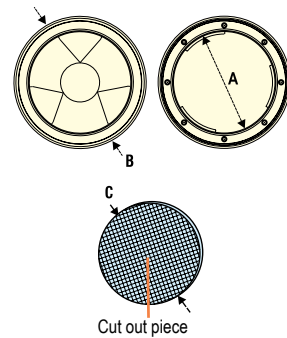

## Inspection Hatch

UV-resistant high-grade ASA  
Self-centering tread with an O-ring to prevent water inflow



Code	Colour	A (mm)	B (mm)	C (mm)
196434	White	108	162	120
196439	Cream			
196441	Grey	133	187	145
196443	White			
196448	Cream	168	222	180
196450	Grey			
196452	White			
196457	Cream			
196459	Grey			

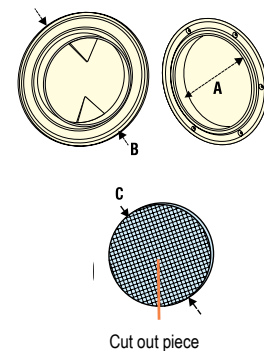

## Inspection Hatches



### Inspection Hatch with Removable Bag

- UV-resistant high-grade ASA
- Self-centering tread with an O-ring to prevent water inflow



Code	Colour	A (mm)	B (mm)	C (mm)
196435	White	108	162	120
196444		133	187	145
196453		168	222	180

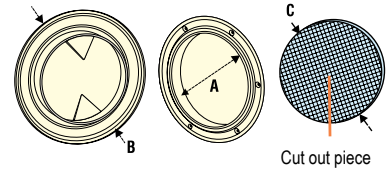

### Inspection Hatch with Pressure Lock

UV-resistant high-grade ASA



Code	Colour	A (mm)	B (mm)	C (mm)
196437	White	108	162	120
196446		133	187	145
196455		168	222	180

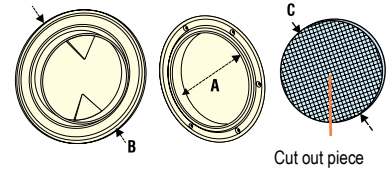

Deck Equipment

## Storage Hatches



### Utility Storage Hatch with Lid

UV-resistant high-grade ASA



Code	Model	Colour	Optional Spare Parts Gasket
196376	Standard	White	 44558 (1,56m)

A (mm)	B (mm)	C (mm)	D (mm)	E (mm)	F (mm)	G (mm)	H (mm)
104	235	205	165	208	81	120	246

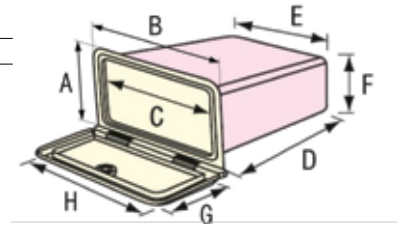

### Utility Storage Hatch, Oval, with Lid

UV-resistant high-grade ASA



Code	Model	Colour	Optional Spare Parts Gasket
196805	Standard	White	 44554 (1,7m)

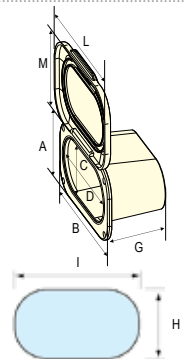

A (mm)	B (mm)	C (mm)	D (mm)	G (mm)	H (mm)	I (mm)	L (mm)	M (mm)
99	170	70	138	73,5	75	145,5	177,5	111,5



### Hatch for VHF/RadioCD

UV-resistant high-grade ASA



Code	Model	Colour	Optional Spare Parts	
			Lock	Gasket
196361	Standard	White		
196362	With lock			
196366	Standard	Cream	44810	44556 (1,5m)

A (mm)	B (mm)	C (mm)	D (mm)	H (mm)	I (mm)	J (mm)	K (mm)
180	285	108	226	130	250	160	279

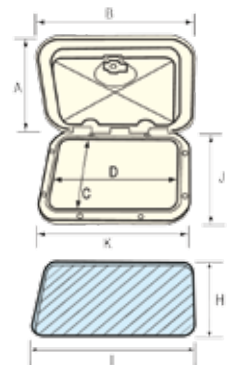





**Storage Hatch for VHF/RadioCD**  
UV-resistant high-grade ASA

Code	Model	Colour	Optional Spare Parts	
			Lock	Gasket
196363	Standard	White		
196364	With lock		44810	44556 (1,5m)

A (mm)	B (mm)	C (mm)	D (mm)	E (mm)	F (mm)	G (mm)	H (mm)	I (mm)	J (mm)	K (mm)
180	285	108	226	250	115	255	130	250	160	279

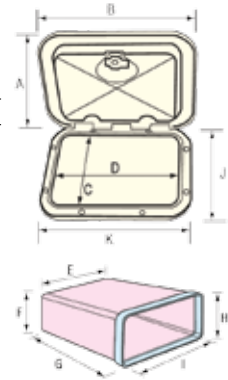

**Storage Hatch for VHF/General Use with chromed durable handle**  
UV-resistant high-grade ASA



Code	Model	Colour	Optional Spare Parts	
			Lock	Gasket
195548	Standard	White		
195555	With lock		44810	44554 (1,7m)

A (mm)	B (mm)	C (mm)	D (mm)	E (mm)	F (mm)
174	292	238	250	236	113

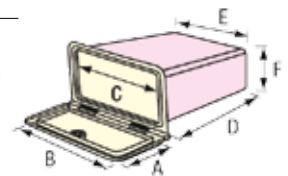

Portlights - Escape Hatches



448x268mm

**Euro 1**

**EURO 1 Hatch**  
UV-resistant high-grade ASA



Code	Colour	Optional Spare Parts			
		Opening Stay	Handle	Gasket	Spare Key
47079	White				
		47089	195425	44561 (1,2m, Ø9mm)	196053

A (mm)	B (mm)	C (mm)	D (mm)	H (mm)	I (mm)	P (mm)	Q (mm)
268	448	196	376	209	389	25-55	22

Plexiglass Thickness: 8mm

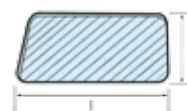



**Euro 2**



**480x480mm**

**EURO 2 Hatch, 48 x 48 cm**  
UV-resistant high-grade ASA



Code	Colour	Optional Spare Parts			
		Opening Stay	Set of left and right handles	Gasket	Spare Key
44445	White				
		44839	44208	44560 (1,6m, Ø9mm)	196053

A (mm)	B (mm)	C (mm)	D (mm)	H (mm)	I (mm)	P (mm)	Q (mm)
480	480	415	415	430	430	25-55	22

Plexiglass Thickness: 8mm

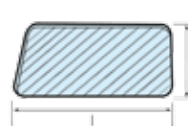
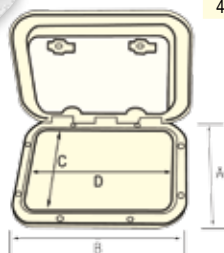

Deck Equipment

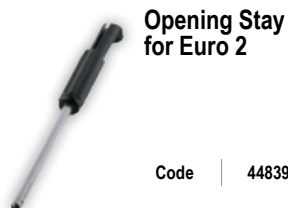





**Euro 38 & 59**

**EURO Escape Hatch Ø38 - Ø59**  
UV-resistant high-grade ASA

**Ø38cm Ø59cm**



Code	Model	Colour	Optional Spare Parts			
			Opening Stay	Set of left and right handles	Gasket	Spare Key
195256	Euro Ø 38	White				
195254	Euro Ø 59		Euro Ø 38: 195541 Euro Ø 59: 195542	195540	44560 (1,6m, Ø9mm)	196053

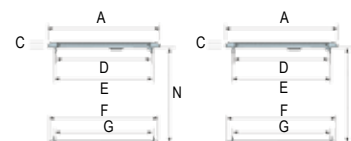

	A (mm)	B (mm)	C (mm)	D (mm)	E (mm)	F (mm)	G (mm)	N (mm)
195256	378	189	26	290	303	362	309	22.5-52.5
195254	590	294.5	27	506	518	574	521	22.5-52.5

Plexiglass Thickness: 8mm

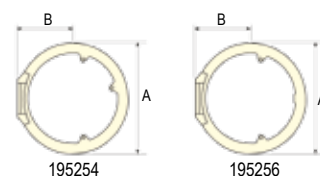

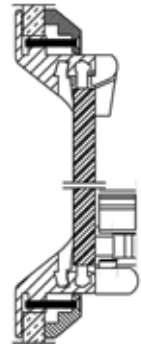
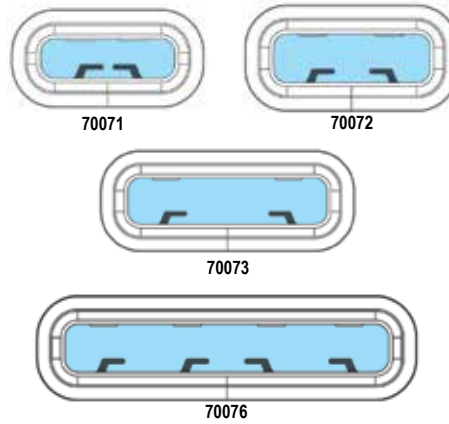
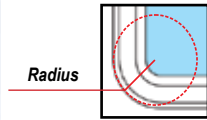

Portlight

Code	Dimensions (mm)			Cut-out Dimensions (mm)			Wall Thicknesses (mm)
	Length	Width	Radius	Length	Width	Radius	
70071	329	180	68	304	155	56	4-20
70072	372	196		347	171		
70073	430	180		405	155		
70076	701	192		676	167		



Deck Hatch, Standard Type, with Flange

Code	Dimensions (mm)			Cut-out Dimensions (mm)			Acrylic (thickness)
	Length	Width	Radius	Length	Width	Radius	
70039	505	375	83	450	320	55	10mm
70043	555	425	83	500	370	55	
70045	555	555	83	500	500	55	
70049	675	675	83	620	620	55	15mm
70050	735	615		680	550		
70051	955	655		900	600		
70052**	1205	805		1150	750		

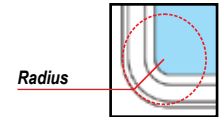

\*\* With gasspring



Deck Hatch, Standard Type, without Flange

Code	Dimensions (mm)			Cut-out Dimensions (mm)			Acrylic (thickness)
	Length	Width	Radius	Length	Width	Radius	
70022	320	320	60	260	260	30	10mm
70023	385	245		325	185		
70024	401	256		341	196		
70026	510	380		450	320		
70027	511	511		451	451		
70028	560	430		500	370		
70029*	560	560		500	500		
70033	680	680	620	620	15mm		

\*\* With gasspring

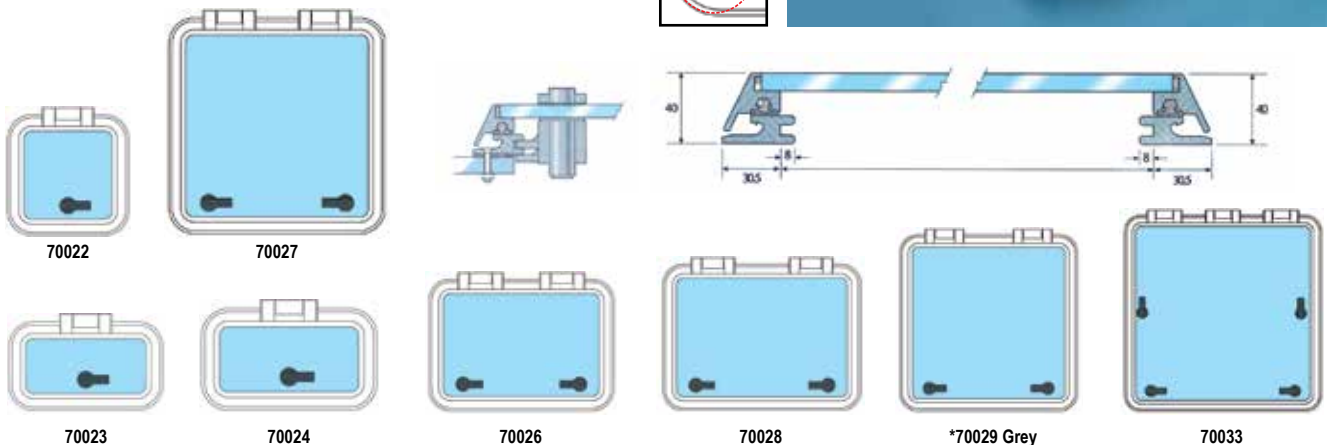
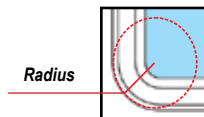

Deck Equipment



## Deck Hatch, Low Profile

Code	Dimensions (mm)			Cut-out Dimensions (mm)			Acrylic (thickness)
	Length	Width	Radius	Length	Width	Radius	
70053	330	330	70	275	275	42	8mm
70054	365	365		310	310		
70055	380	240		325	185		
70056	475	475		420	420		
70057*	475	475		420	420		
70058	505	375		450	320		
70061*	525	525		470	470		
70062	555	425		500	370		
70064	565	565		510	510		
70065*	565	565		510	510		
70066	675	675	620	620	10mm		

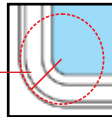

Radius

\* With stay



Deck Equipment

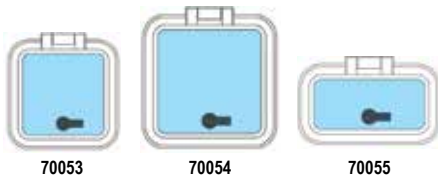

70053

70054

70055



70056, 70057\*

70058

70061\*



70062



70064, 70065\*



70066



## Fly Screen

Code	For deck hatches with cut-out dimensions
70726	450 x 320mm (70026 70039, 70058)
70727	620 x 620mm (70033, 70049, 70050, 70066)
71442	500 x 500mm & 510 x 510mm (70029, 70031, 70032, 70045, 70046, 70047, 70064, 70065)



**Sealing Rubber R163**  
for Gebo Standard hatches with & without flange

Code | 71110

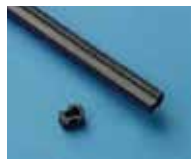

**Sealing Rubber R102** for Gebo Flushline Hatch

Code | 71111



**Sealing Rubber for Gebo Econoline Portlights**

Code | 70935



**Handle for Hatch, Left, Set**

Code | 70934



**Handle for Hatch, Right, Set**

Code | 71213



**Blue Lock for Hatch**

Code | 70721\*

\* For hatches with cut-out size up till 500 x 500 mm



## Hatch Insect Screen

Premium quality net that protects against all kinds of insects, while the hatch is open. Installation is fast and easy. The boat hatch insect screen is designed to be hand-thrown over your boat hatch. No velcro, strings or frame needed, which allows you to open or close the hatch from inside. A convenient storage bag allows easy storage. The hatch insect screen comes in three different dimensions so as to cover a wide range of available hatches in the market.

Code	Dimensions (mm)			Applicable to Hatches, with maximum dimensions (mm)
	Length	Width	Height	
70983	540	540	350	540x540
70984	650	650	420	650x650
70985	750	750	515	750x750



## Door Insect Screen

- It is made of NET fabric and is supplied with lead rope
- It is suitable for the door of the boat
- Available in two different dimensions

Code	Dimensions (cm)		Suitable Boats
	Length	Width	
70986	170	120	Suitable for Catalina (except 30.380.400), Caliber and Endeavour sailboats
70987	180	90	Suitable for most sailboats except for Catalina, Caliber & Endeavour



Deck Equipment

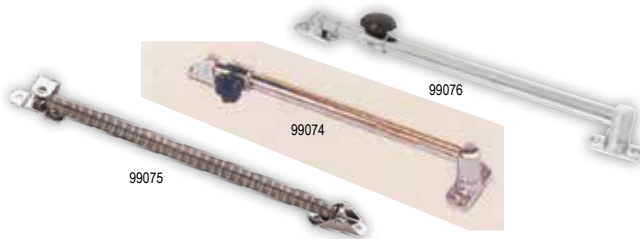

## Hatch Adjuster

Code	Description
99074	254mm(10") to 483mm(19"), chrome plated brass
99075	Hatch adjuster, 11mmx210mm(L), stainless steel
99076	Hatch adjuster, 284mm(11-3/16") to 491mm(19-5/8"), chrome plated brass



## Gasket



Code	Description	Length (m)
44556	for 90° hatches	1,5
44558	for 180° hatches	1,56
44554	for TOP LINE/MID LINE/CLASSIC hatches	1,7
70143	for INDUSTRIAL hatches	2

# Deck Fillers



## Deck Fillers for Gas, Diesel, Water & Waste

The Deck Filler range includes deck fillers suitable for water, fuel and waste. They are designed in such a way that the full lid area is totally covered, which makes the final look much more attractive. Each deck filler can have a different function, which will always be clear - by using the relevant sticker (water, fuel, waste) included in each filler's packaging. They are made of highly resistant plastic and in 38mm and 50mm diameter. Available option with a chrome plated cap.

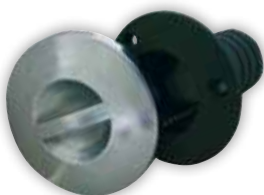

Deck Filler with Chrome Plated Cap

Code	70594	70595
Tube Diam.	38mm (1-1/2")	50mm(2")



Deck Filler with Cap

Code	99567	99568
Tube Diam.	38mm (1-1/2")	50mm(2")



38 (1-1/2")



50 (2")

Hose diam. D1 (mm/inch)	H (mm)	H1 (mm)	diam. D (mm)	Cut out D2 (mm)
38 (1-1/2")	84	66	92	55
50 (2")				

**new**

## INOX Deck Filler Ø38mm

Nuova Rade Inox Deck Fillers with Cap are suitable for fuel, fresh water or waste. The use is easily indicated by the colour of the cap: blue for fresh water, red for fuel and brown for waste. The main body is made of reinforced PA. The cap is made of Inox 316 and reinforced PA for endurance and extra durability in the marine environment. The cap features a lanyard in order not to be lost or fall into the water. These deck fillers have a tight fitting, as they can be secured with the use of a winch handle.

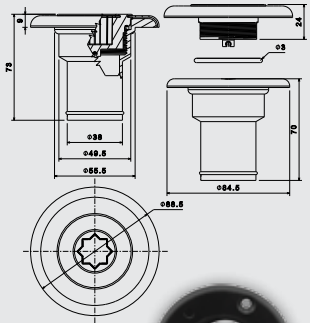

Code	Model	Diameter (mm)
198158	Water	38
198159	Fuel	
198160	Waste Water	



Deck Equipment

## Deck Filler Inox, with Vent Ø16 mm

Deck Filler with vent is made of Inox. Depending on the use, you can choose the Deck Filler either for gas or water. The indication of use is shown at the top of the Deck Filler. It combines stylish design and complete sturdiness, and it is designed to fit easily on the deck. The cap features a lanyard in order not to be lost or fall into the water. Nuova Rade Deck Fillers are available in Ø38 mm with a vent of Ø16 mm.

Code	74326	74327
For use	Gas	Water
Diameter (mm)	38	



## Deck Filler, Glass Reinforced PA

Construction in 2 materials to combine sturdiness, lightweight and stylish design:

- Deck filler's body in glass reinforced nylon
- 316 L Inox Cap
- Open with dual imprint key or manually thanks to finger-grip cap; the type of the liquid included (fuel, diesel, water) is written on the cap

Code	Model	Hose diam. (mm/inch)	H (mm)	H1 (mm)	H2 (mm)	diam. D (mm)	diam. D1 (mm)	diam. D2 (mm)	
197206	Water	38 / 1 1/2"	75	62	23	92	50	38	
197203	Fuel	51 / 2"			-				-
197205	Diesel				-				-

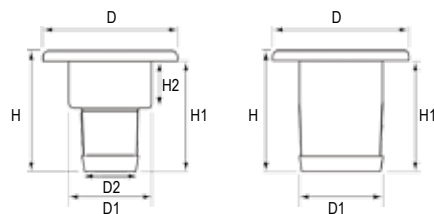

## Plastic Deck Filler, Flip Top

Code	Model	Hose Ø (mm)
196275	Water	38 (1 1/2")
196265	Fuel	38 (1 1/2")
196266		51 (2")
196267	Diesel	38 (1 1/2")
196268		51 (2")

	A (mm)	Ø B (mm)	Ø C (mm)	D (mm)	E (mm)	F (mm)	G (mm)	Ø N (mm)	K (mm)	J (mm)
Ø 38	80x93	55	48	33	26	72	46	38	84	98
Ø 51	80x93	55	48	33	26	72	46	51	84	98

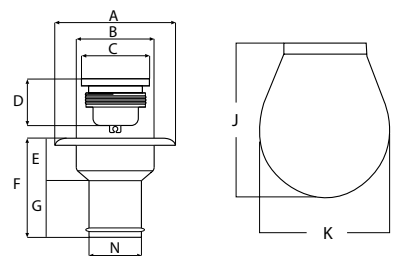



**Spare Deck Filler Cap with Chain for Fuel**

Code | 195015



**Spare Deck Filler Cap with Chain for Water**

Code | 195016



**Plastic Deck Filler**

Code	Model	Hose Ø (mm)	Colour
45298	Water	38 (1½")	White
47618			Cream
45299			Black
35011	Fuel	38 (1½")	White
50311			Cream
45282		51 (2")	White
45283			Black

	A (mm)	Ø B (mm)	Ø C (mm)	D (mm)	E (mm)	F (mm)	G (mm)	Ø N (mm)
Ø 38	85	55	48	33	26	72	46	38
Ø 51	85	55	48	33	26	72	46	51

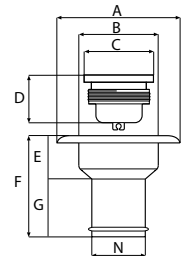

**Case with Deck Filler**

Made of plastic material, incorporating a deck filler of Ø38 mm

Code	Use	Hose Ø (mm)	Colour
44306	Water	38	White
50023	Fuel		
50025	Diesel	38	Cream
50024	Fuel		

A (mm)	B (mm)	C (mm)	D (mm)	G (mm)	H (mm)	I (mm)
145	191	110	155	80	115	155

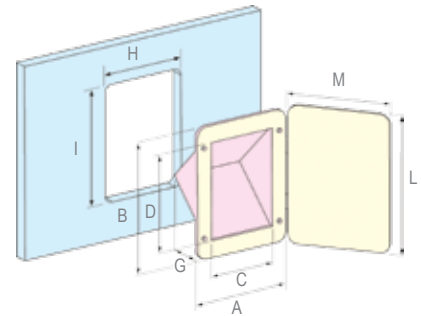

**Case with Deck Filler and Lid**

The body is made of PA and the lid is made of ASA.

Code	Use	Hose Ø (mm)	Colour
196419	Water	38	White
196417	Fuel		
196418	Diesel	50	White
196415	Fuel		

A (mm)	B (mm)	C (mm)	D (mm)	G (mm)	H (mm)	I (mm)	L (mm)	M (mm)
145	191	110	155	80	115	155	200	165

**Case for Deck Filler**

Made of PA material.

Code	Colour
44302	White
647442	Cream



**Case for Deck Filler with Lid**

The body of the product is made of PA and the lid is made of ASA.

Code	Colour
196414	White

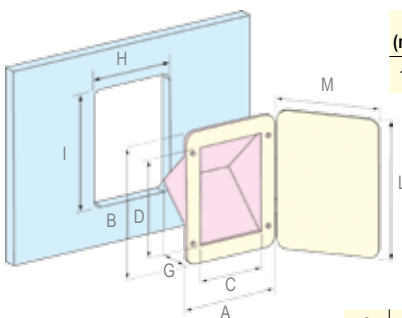

A (mm)	B (mm)	C (mm)	D (mm)	G (mm)	H (mm)	I (mm)
145	191	110	155	80	115	155

A (mm)	B (mm)	C (mm)	D (mm)	G (mm)	H (mm)	I (mm)	L (mm)	M (mm)
145	191	110	155	80	115	155	200	165



## Hatch Ventilating Sail

Aerodynamically designed to provide optimum ventilation in your cabin, channeling the air down into the hatch. It is made of strong nylon for durability and high resistance against the strong winds. If installed correctly, it will not flutter and will prevent any whistling and flapping noise.

Κωδικός | 11087

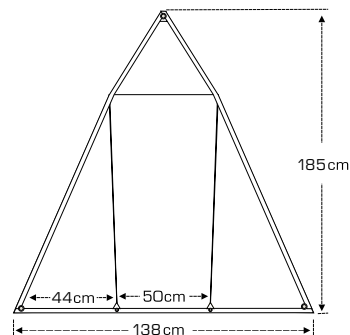

## Hatch Ventilating System 4D Windtrap

- It provides an easy and efficient way to funnel air into the cabin in order to ventilate it
- It is fastened inside the open hatch and a halyard is used to lift the top
- The design helps it to collect the outside wind from every direction (4 Drive Windtrap) and flow it through the hatch, inside the cabin
- It is made of polyester 420D and the fabric is silver-blue
- Supplied in two different sizes



Code	Dimensions (mm)			Applicable Hatches
	Length	Width	Height	
70982	300	300	800	<b>Gebo:</b> 70039 (505x375mm), 70043 (555x425mm), 70053 (330x330mm), 70054 (365x365mm), 70057 (475x475mm), 70058 (505x375mm)
				<b>Lalizas:</b> 11103 (250x606mm), 10264 (358x606mm), 11101 (460x511mm)
70981	550	550	1260	<b>Gebo:</b> 70045 (555x555mm), 70046 (555x555mm), 70047 (555x555mm), 70059 (525x525mm), 70061 (525x525mm), 70062 (525x425mm), 70063 (555x425mm), 70064 (565x565mm), 70065 (565x565mm), 70066 (675x675mm)

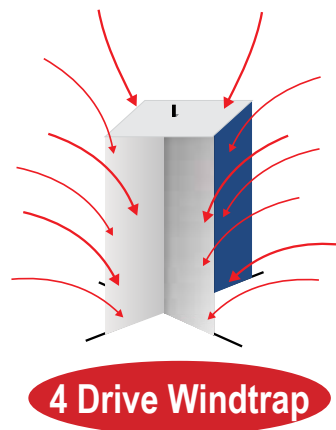

Deck Equipment

# Utility Cases



196673

Made of highly resistant plastic material



196675

## Utility Storage Case, Side mounted

Code	Description	Colour
196671	Right	White
196773	Left	
196673	Right with glass holder	
196775	Left with glass holder	

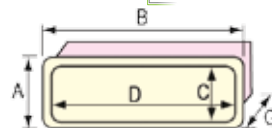

A (mm)	B (mm)	C (mm)	D (mm)	G (mm)	H (mm)	I (mm)
266	561	195	475	125	496	200



## Utility Storage Case, 1/2 Open



Code | 45344  
Colour | White

A (mm)	B (mm)	C (mm)	D (mm)	G (mm)	H (mm)	I (mm)
170	420	120	370	100	380	130

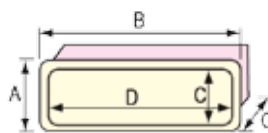

## Handle-Sunglasses Holder

Code	Colour	Length (mm)	Height (mm)
44535	White	175	85





**Storage Case, Flush mounted**

High-quality storage case ideal for storing your items when on board. Saves a lot of space on deck, since your belongings are organised in one place. Optionally, it can be fitted with single or full cover to protect the contents from spray. Can be placed vertically or horizontally on any flat surface and can be easily mounted by using silicone or polyurethane construction adhesive. On the rear side of the cases, drilling points are marked, in case screws are required. Made of highly resistant plastic material, while the optional covers are made of tinted see-through acrylic (PMMA) for durability and visibility. Available in different dimensions and in white colour.



11464



11459

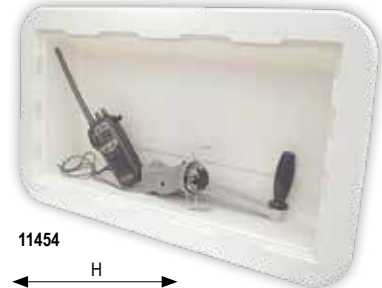

11454

Code	A (mm)	B (mm)	C (mm)	H (mm)	I (mm)
11464	428	184	112,5	385	140
11459	545	245	121	485	193
11454	692	394	132	597	300

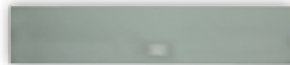
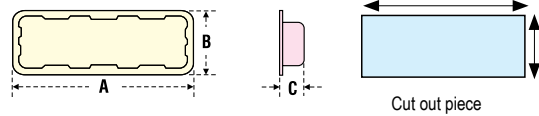

11466



11458

**Storage Case Cover**

Made of tinted see-through acrylic (PMMA) for durability and visibility.

Code	Length (mm)	Width (mm)	Thickness (mm)
11466	385	68	4
11458	304	304	5

**Choosing the right Cover for your Storage Case (Optional)**

Storage Cases Codes	Storage Cases Covers Codes	
	Single Fixed	Horizontal Full Sliding
11454	-	11458
11464	11466	-

**Case for Toilet Paper with Door**

High quality Case for Toilet Paper with Door, ideal for every sailboat's or yacht's toilet. Available in dimensions of 160 x 160mm and in white colour, this case can cover the needs of boats of any size. It is made of white ASA plastic in order to provide resistance to damage and chemical solvents. Designed for internal use. It is ideal for storing your toilet paper, using its holder (195258). Contains a 180° opening door. This case is mounted with hidden screws for discrete appearance.



A (mm)	B (mm)	C (mm)	D (mm)	E (mm)	F (mm)	G (mm)	H (mm)	I (mm)
160	160	118	128	118	167	162	125	135

Code | 195263

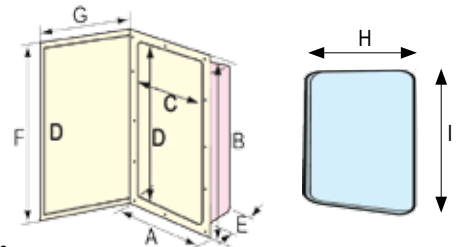

**Case for Shower**

It is made of PA material. With easy installation and available in white colour.

A (mm)	B (mm)	C (mm)	D (mm)	G (mm)	H (mm)	I (mm)
145	191	110	155	80	115	155

Code	Colour
44301	White

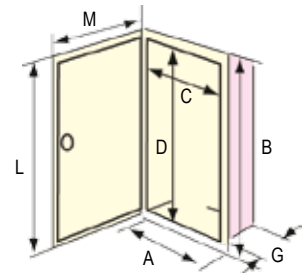

**Case for Shower with Lid**

The body of the product is made of PA and the lid is made of ASA. With easy installation and available in white colour.

Code	Colour
196420	White
196471	

Code	A (mm)	B (mm)	C (mm)	D (mm)	G (mm)	H (mm)	I (mm)	L (mm)	M (mm)
196420	145	191	105	150	80	1115	155	200	165
196471	165	237	110	183	95	114	187	247	186

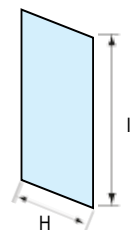



### Case for Deck Filler

Made of PA and produced to have easy installation. Available in white & cream colour.

Code	Colour
44302	White
647442	Cream

A (mm)	B (mm)	C (mm)	D (mm)	G (mm)	H (mm)	I (mm)
145	191	110	155	80	115	155

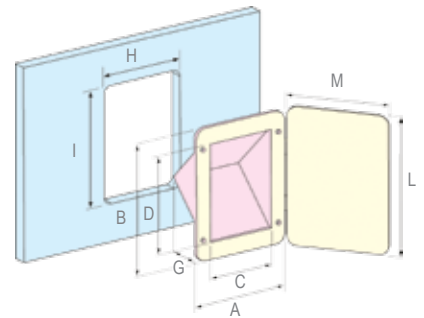

### Case for Deck Filler with Lid

The body of the product is made of PA and the lid is made of ASA with very easy installation & available in white colour.

Code	Colour
196414	White

A (mm)	B (mm)	C (mm)	D (mm)	G (mm)	H (mm)	I (mm)	L (mm)	M (mm)
145	191	110	155	80	115	155	200	165

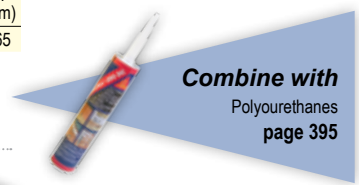

Deck Equipment



### Twin Case for Shower & Water Tap, with Lid



Code	Lid Colour
55800	White
196686	Cream
55801	Chrome



### Case for Shower Head, with Round Lid

Code	Lid Colour
42575	White
46170	Chrome

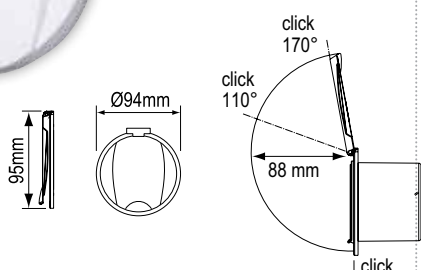

### Case for Shower Head, with Square Lid

Code	Lid Colour
196399	White
196401	Cream

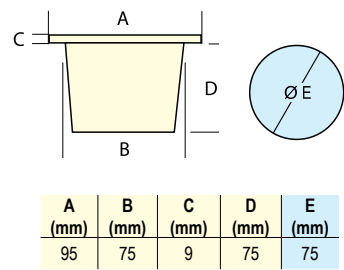

### Case for Water Tap, with Lid, Round

It is suitable for mixer tap and water tap and it is available with lid in white or chrome colour.

Code	Lid Colour
42576	White
46171	Chrome

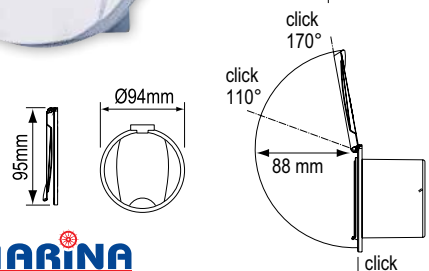

### Case for Water Tap, with Lid, Square

It is suitable for mixer tap and includes a gasket. Available in white and cream colour.

Code	Case Colour
196391	White
196395	Cream

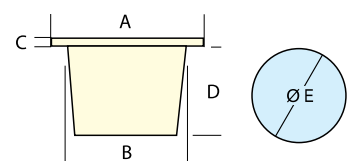



**Case for Shower Head, Square, with Lid**

Code	37214
Colour	White

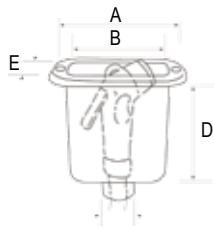

A (mm)	B (mm)	C (mm)	D (mm)	E (mm)
125	87	30	97	90

**Combine with**  
Polyurethanes  
page 394



**Case for Shower Head, Round, with Lid**

Code	35791
Colour	White

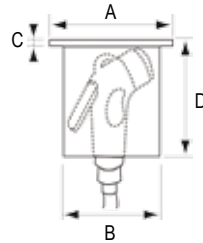

A (mm)	B (mm)	C (mm)	D (mm)
88	66	5	80



**Case for Battery Switch with Watertight Lid**

It has a UV-resistant outer case made of ASA in order to store the battery and protect it from external factors. Watertight gasket is included.

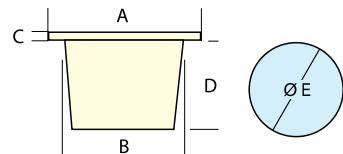

Code	Colour
196383	White
196387	Cream

A (mm)	Ø B (mm)	C (mm)	D (mm)	E (mm)
95	68	5	72	75

Deck Equipment



**Case Cover for Radio/CD**

Ideal to protect the Radio/CD player of your boat. Suitable for all 1 DIN (180mm x 50mm) units of the market. Options in white colour with flat cover, and in smoked transparent colour with flat or curved cover.



Code	Colour
50281	White
195265	Smoked, transparent, mat
196069	Smoked transparent, clear

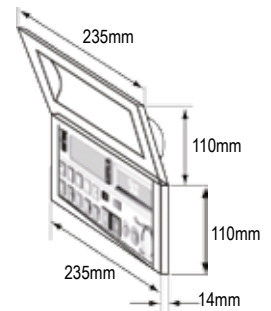

**Case for Electrical Control Panel, with Lid**

It is ideal for storing the boat's electrical control panel. Made of UV-resistant high-grade ASA plastic, it provides resistance to damage and chemical solvents. Preferably designed for internal use. UV-resistant cover, frame and container with a 150° opening door and a durable handle. It is specially designed with a non-skid surface and can be mounted vertically. This case is mounted with hidden screws for discrete appearance. EPDM rubber gasket provides resistance to water. It guarantees easy opening and easy access when needed.

Code	196663
Colour	White

A (mm)	B (mm)	C (mm)	D (mm)	E (mm)	F (mm)	G (mm)
275	375	180	280	75	200	300

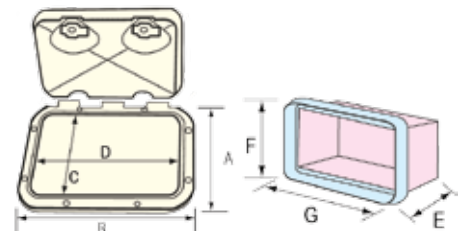

## Storage Case for Fire Extinguisher

Allows safe and protected storage of a fire extinguisher in the cockpit or dashboard. This product is impervious to harsh weather, watertight and offers easy and safe access during emergency situations. A well-made product that offers very precise lid/door closure. Made of UV-resistant white ASA. The elimination of metal reduces the chance of personal injuries. No sharp corners. No glass to shatter

Code	Extinguisher Capacity (kg)	Door	Colour
196461	1	Yes	White
196666		Transparent	
50006		No	
196465	2	Yes	
196675		Transparent	
50010		No	

Fire Extinguisher	A (mm)	B (mm)	C (mm)	D (mm)	E (mm)	F (mm)	G (mm)	H (mm)	I (mm)
1 kg	174	424	120	370	105	434	196	124	374
2 kg	204	474	150	415	120	484	226	154	424



Deck Equipment

**Combine with**  
Fire Extinguishers  
page 55

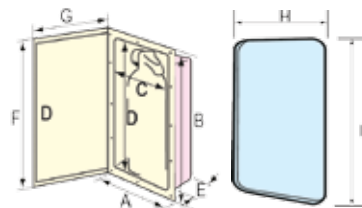

### Horizontal Mounting

- Easy to mount
- Various mounting options

1. With screws

2. With fixed mount support base (99826-7)



For all  
"Store-All" cases

### Vertical Mounting

1. With screws

2. With fixed mount support base (99826-7)

3. With rail support base (99824-5)

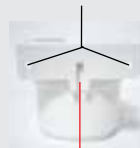

## Store All Isotherm Cover for Drinks

Whether you like your coffee to stay hot in the winter or your refreshments cold in the summer, this cover is a 'must-have' for you. It is manufactured in such a way that your beverage will be at the same temperature (hot or cold) longer than it would be without. It has been designed to easily cover most common cans or cups. It can be fitted in the various Store-All drink holders (94144-5, 94161, 99232).



Code	99828
Colour	Blue
Ext. Diameter (cm)	8.1
Height (cm)	10
Internal Diameter (cm)	6.5

## Store-All Drink Holder

This compact and convenient cockpit saver keeps your drinks up and out of the way. You can place it on any smooth surface, by using the support base (99824-7) on the back or bottom of the holder. Available in white and graphite colour.



Code	94161	99232
Colour	White	Graphite
Length (cm)	11	
Width (cm)	11	
Height (cm)	10	
Internal Diameter (cm)	9 / 9,3	
Internal Height (cm)	9	



### Store-All VHF/FRS Case

With the VHF/FRS case you can keep your communication devices safe and within easy reach. Due to its small size, it can even fit close to the helm of the smallest boat. In order to mount the case, you can place the support base (99824-7 - not included) either on the back or on the bottom of the case. The case is available in white colour.



<b>Code</b>	<b>94152</b>
<b>Colour</b>	White
<b>Length (cm)</b>	13,5
<b>Height (cm)</b>	11,5
<b>Width (cm)</b>	8
<b>Internal Length (cm)</b>	9



### Store-All Galley Case

This handy case is suitable for keeping your sponges, brushes, sun-block or any small object organised. It is easily mounted using the special support base for cases (99824-7 - not included), which can be placed on the wall, on the console or on the rails. It is available in white colour.



<b>Code</b>	<b>94160</b>
<b>Colour</b>	White
<b>Length (cm)</b>	19
<b>Height (cm)</b>	10
<b>Width (cm)</b>	11,3
<b>Internal Length (cm)</b>	14,3



### Store-All GPS/Cell Phone Case

Ideal for storing most hand-held GPS and mobile phones. It can be placed vertically or horizontally on any flat surface, by using the support base for rails and surfaces (99824-7), which allows you to remove the case easily and fast. Available in white colour.



<b>Code</b>	<b>94150</b>
<b>Colour</b>	White
<b>Length (cm)</b>	18,5
<b>Height (cm)</b>	10,5
<b>Width (cm)</b>	9



### Store-All Organiser & Drink Holder

This is perfect for you, if there are not any storage cases for small objects on board. It features drink holder and a case to hold sunglasses, sunblock etc. It is easily mounted either vertically or on a flat surface, using the support base for rails or level surfaces (99824-7), which allows you to remove the Organizer anytime. Available in white colour.



<b>Code</b>	<b>94144</b>
<b>Colour</b>	White
<b>Length (cm)</b>	26,5
<b>Height (cm)</b>	10
<b>Width (cm)</b>	11



### Store-All Folding Drink Holder

Ideal for small boats or areas with very limited space. Its folding feature allows you to completely retract it when you do not use it. It features adjustable arms to hold cans and mugs and also screws for permanent mounting. This drink holder can also be mounted on the rails or against any surface, using the relevant support base (99824-7), which allows you to remove the holder when not in use. Available in white and graphite colour.



<b>Code</b>	<b>96866</b>	<b>99230</b>
<b>Colour</b>	White	Graphite
<b>Height (cm)</b>	11	
<b>Length (cm)</b>	10	
<b>Width (cm)</b>	10,5	
<b>Internal Length (cm)</b>	9,2	

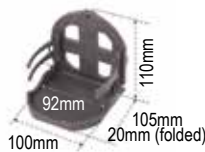

### Store-All Folding Helm Organizer

When space is very limited on the deck and you have no room to leave small objects like sunglasses, keys or your drink, then all you need is this organizer. Its mechanism allows you to use it only when needed and fold it when you do not. It features a drink holder and inox screws for permanent mounting. However, you can also mount it using the support base (99824 - 5), which allows you to completely remove the organizer anytime. Available in white and graphite colour.



<b>Code</b>	<b>96865</b>	<b>98591</b>
<b>Colour</b>	White	Graphite
<b>Length (cm)</b>	25,8	
<b>Height (cm)</b>	11	
<b>Width (cm)</b>	10,5	

### Store-All Utility Hook, Set of 2 pcs

Ideal for multiple uses on board. You can place it on a flat surface of your boat and use it to tie lines, hang clothing or towels, etc. It is available in a pack of two, in white and graphite colour. Made of plastic.



<b>Code</b>	<b>94126</b>	<b>99231</b>
<b>Colour</b>	White	Graphite
<b>Length (cm)</b>	2,5	2,5
<b>Height (cm)</b>	7,5	7,5
<b>Width (cm)</b>	3	3

### Store-All Trash Bag Holder

Keep your cockpit and cabin tidy and clean. This holder can be easily mounted on any flat and even surface, with the use of the support base for rails or level surfaces (99824-7), so that you can store it easily and quickly. Its cover prevents the contents from falling out of the bag. You may use common supermarket bags or kitchen trash bags. Available in white colour.



<b>Code</b>	<b>94146</b>
<b>Colour</b>	White
<b>Length (cm)</b>	28
<b>Height (cm)</b>	6,5
<b>Width (cm)</b>	13,7

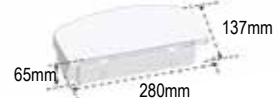

Deck Equipment

## Rail Support Base for Store-All Case



This support base allows you to mount semi-permanently the Store-All cases on the rails. All you have to do is mount the support base on the rails and then slide the case in. When you do not want to use the case, just remove it. The support base will remain on the surface for as long as you want it. Available in white and graphite colour.

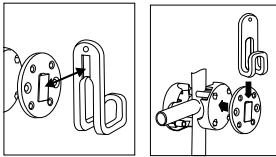

Code	99825	99824
Colour	White	Graphite
Diameter (cm)	6	
Width (cm)	4,5	

## Fixed Mount Support Base for Store-All Case



This support base allows you to mount the Store-All cases semi-permanently. All you have to do is to mount the support base on the surface you want and then slide the case in. When you do not want to use the case, just remove it. The support base will remain on the surface until the next time you need it. Available in white and graphite colour.

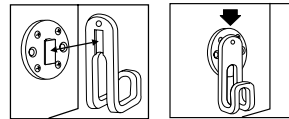

Code	99827	99826
Colour	White	Graphite
Diameter (cm)	6	
Thickness (mm)	9	

## Case 'Store-All' with Net and Plastic Frame,

It is ideal for organising all your belongings when on board with the help of a flexible holding net. Made of UV-resistant plastic, it provides resistance to damage and chemical solvents. Can be easily installed on your boat either with screws or with a sticker (supplied), appropriate for inflatable and rigid boats. Available in white colour.



Code	Colour	Thickness (mm)	Height (mm)	Width (mm)
11900	White	20	120	205
11901		10		

## Clip-on CAN HOLDER

This is a unique and useful accessory, ideal for holding and keeping cool cans, small bottles, and glasses. It is one-piece made and there is no need for extra parts. It preserves the temperature levels of the mounted object. It can also be used as an object holder for mobile phones, eye - glasses, portable VHF and GPS, etc. It is made of Flexible Integral PU Skin Foam technology and can be clipped on all guardrails, pulpit and stanchion, making it an essential accessory on board.



○ 470089

● 197762

GUARDRAILS Ø (mm)	L (mm)	W (mm)	H (mm)	Weight (kg)
22-26	130	90	100	0,25



## ALVEA Drinks Tray

ALVEA is a unique and useful glass and bottle tray, made of Flexible Integral PU Skin Foam technology and non-slip material. Thanks to the moulded design, the cups - either plastic or glass - are held firmly even when they are empty or during strong winds, making ALVEA an essential accessory on board. In addition, it keeps the table tidy and it's easy to clean, by using only soap and water.



● 473084

L (mm)	W (mm)	H (mm)	Weight (kg)
270	230	50	0,3





**Eye Bolt, with Nut & Washer, Inox 316**

Surface\*: E.P. - Body: Forging - Screw: Casting

Code	Size (mm)	A (mm)	B (mm)	C (mm)	D (mm)	E (mm)
91394	6 X 40	26	16	74	6	40
91396	6 X 80	26	16	112	6	80
91744	6 x 100	26	16	133	6	100
96951	8 x 38	32	20	78	8	38
91397	8 X 80	32	20	120	8	80
91749	10 X 80	40	25	128	10	80
91399	10 X 100	40	25	148	10	100
91752	10 X 140	40	25	188	10	140
91755	12 X 140	48,8	30	200	12	140
96955	12 X 180	48,8	30	240	12	180

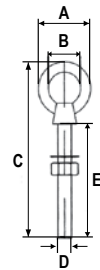

**Eye Bolt, (Lag Screw), Inox 316**

Surface\*: E.P.

Code	Size (mm)	A (mm)	B (mm)	C (mm)	D (mm)
96976	4x45	4	8,5	45	30
97003	6x55	6,5	12	57,3	45
97001	8*80	8	16	80	55
92783	10*80	10	20	78	59

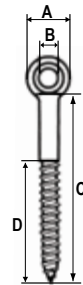

**Eye Wood screw, Inox 316**

Surface\*: E.P. - Body: Casting

Code	Size (mm)	A (mm)	B (mm)	C (mm)	D (mm)
92858	6 x 40	16	6	62,5	41
92860	6 x 80	16	6	80	55
93188	6 x 100	16	6	100	65
93179	8 x 60	18,5	8	62	40
93181	8 x 100	18,5	8	100	65
92862	10 x 80	22	10	82	66
93183	10 x 120	22	10	103	62
93185	12 x 120	27	12	123	98
93187	12 x 160	27	12	160	120

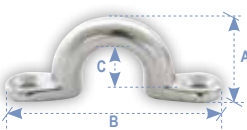

**Eye Strap, AISI 316**

Code	98521	98522	98523
Size (mm)	4	5	6
A (mm)	15,5	17,5	20
B (mm)	44	52	56
C (mm)	10	12	14

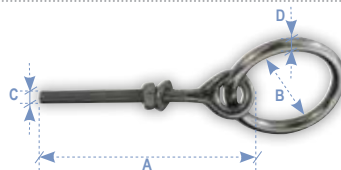

**Eye Bolt with Ring, AISI 316**

Code	98531	98532	99219	99220
A (mm)	75	75	100	120
B (mm)	35	45	50	60
C (mm)	M6	M8	M10	M12
D (mm)	6	8	10	12



**Eye Strap, AISI 316**

Code	97027	97028	97029	97030	97032
Size (mm)	4	5	6	8	10
A (mm)	40	50	57	63	78
B (mm)	32	40	44	47	65
C (mm)	11	13	16	17	18
D (mm)	3,2	4,2	5,2	5,2	6,4

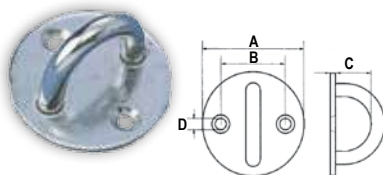

**Round Pad, Hook Type, AISI 304**

Code	95675	95676	95677
Size (mm)	5	6	8
A (mm)	33	40	50
B (mm)	20	23	30
C (mm)	12	17	21
D (mm)	4,2	4,2	5,2

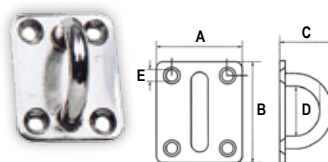

**Square Pad, AISI 304**

Code	91391	91392	91393
Size (mm)	5	6	8
A (mm)	30	35	40
B (mm)	35	40	50
C (mm)	19	26	33
D (mm)	14	18	20
E (mm)	4,2	5,2	5,2

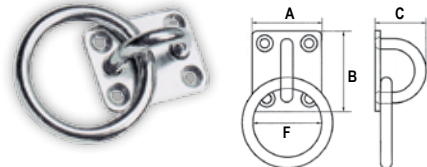

**Spare Pad with Eye Ring, AISI 304**

Code	92852	92853	92854
Size (mm)	5	6	8
A (mm)	30	35	40
B (mm)	35	40	50
C (mm)	19	26	33
F (mm)	30	40	50



## Pad Eyes



**Diamond Pad with Ring, AISI 304**

Code	90447	91733	91734
Size (mm)	5	6	8
A (mm)	37	50	60
B (mm)	59	64	80
C (mm)	22	26	33
D (mm)	11	15	18
E (mm)	4,2	4,2	5,2

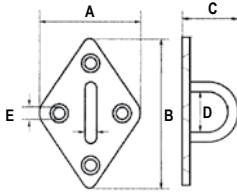

**Eye Nut, AISI 316**

Code	92864	92865	92866	92812
Size (mm)	6	8	10	12
A (mm)	16	20	25	30
B (mm)	31	36	45	54
C (mm)	6	8	10	12

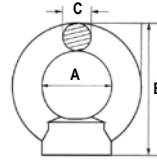

Deck Equipment



**Deck Clips, AISI 316, L. 34-65mm, Diam. 5mm**

Code | 92695



**Deck Clips, AISI 316, L. 34mm, Diam. 5mm**

Code | 92692



**Eye Plate on Horizontal Curved Base, Diam. Ring 5mm**

Code | 92755



**Eye Plate on Vertical Curved Base, Diam. Ring 5mm**

Code | 92756



**Single Eye Mast Spinnaker Pole Bracket, Ring Diam. 6mm, Holes Diam. 5mm**

Code | 92762



**Spar Attachment on Horizontal Curved Base, Ring Diam. 6mm, Holes Diam. 5mm**

Code | 92764

## Shackles

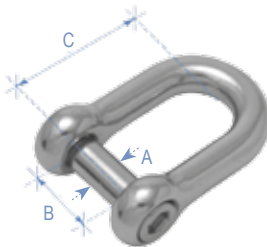

**Shackle, Type D, with Inter. Hexagonal Sink Pin, AISI 316**

Code	90434	90468	90469	90470
Size (mm)	6	8	10	12
A(mm)	6	8	10	12
B(mm)	13	16	19	25
C(mm)	28	36	43	57
Working load (kg)	100	200	320	520

\*Surface: E.P, Body: Casting, Pin: Forging

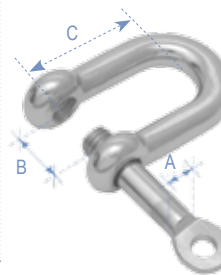

**Shackle, Type D, with Locking Pin, AISI 316**

Code	91863	91864	91865	92145	97000
Size (mm)	5	6	8	10	12
A(mm)	4,40	5,25	7,10	8,90	10,7
B(mm)	10	12	16	20	24
C(mm)	20	24	35	40	48
T.D.L.*	1,000	1,400	2,800	4,000	6,200
R.W.L.*	250	350	700	1,000	1,550

\*Surface: E.P, Body: Casting, Pin: Forging

**Shackle, Type D, AISI 316**

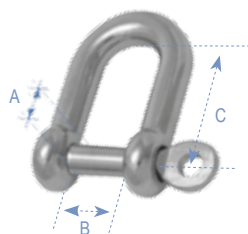

Code	90432	91189	91190	96694	91191	96881	91192	91193	91194	91195	91196
Size (mm)	4	5	6	7	8	9	10	12	13	14	16
A(mm)	4	4,8	5,8	6,8	7,8	8,8	9,8	11,8	12,8	13,8	15,8
B(mm)	8	10	12	14	16	18	20	24	26	28	32
C(mm)	16	20,21	24,25	28,37	32,48	36,66	40,8	49,27	53,68	57,97	66,7
Working load (kg)	55	80	100	150	200	260	320	520	580	660	800

\*Surface: E.P, Body: Casting, Pin: Forging





Shackle, Type D, Large, Galvanized

Code	99229	98506	98507	98557	98558	98508	98509
Diameter (mm)	5	6	8	10	12	14	16

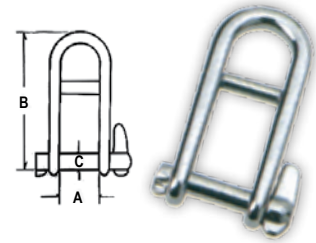

Shackle, Type Halyard, with Cross Bar & Locking Pin, Inox 316

Code	90435	90466	90467
Size (mm)	5	6	8
A(mm)	13	15	21
B(mm)	40	46	64
C(mm)	5	6	8

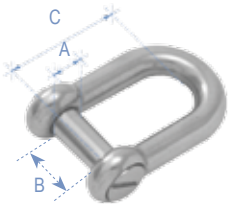

Shackle, Type D, with Oval Sink Pin, Inox 316

Code	96884	91880	91304	91305	96966	91306	91307
Size (mm)	4	5	6	8	9	10	12
A(mm)	4	5	6	8	9	10	12
B(mm)	8	10	12	16	18	20	24
C(mm)	16	20	24	32	36	40	48
Working load (kg)	400	800	1200	1800	2500	3200	4400

\*Surface: E.P, Body: Casting, Pin: Casting

Anchor Shackle, Type Ω, Galvanized

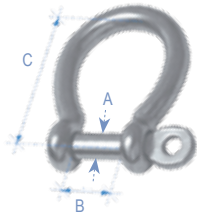

Code	99414	99415	99416	99417	99418	99421
Size (mm)	5	6	8	10	12	16
A(mm)	5	6	8	10	12	16
B(mm)	10	12	16	20	24	32
C(mm)	20,5	30	41	51	61	82

\*Surface: E.P

Anchor Shackle, Type Ω, Inox 316

Code	90433	91200	91201	91202	91203	91204	91205	91206	91207
Size (mm)	4	5	6	8	10	12	13	14	16
A(mm)	4	4,8	5,8	7,8	9,8	11,8	12,8	13,8	15,8
B(mm)	8	10	12	16	20	24	26	28	32
C(mm)	18	22,5	27	36	45	54	58,5	63	72
Working load (kg)	55	80	100	200	320	520	580	660	800

\*Surface: E.P, Body: Casting, Pin: Forging

Shackle, Type D, Long, AISI 316

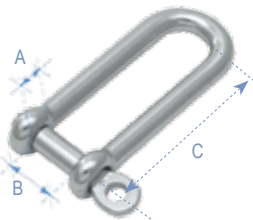

Code	91312	91313	91314	91315	91316	91221
Size (mm)	4	5	6	8	10	12
A(mm)	4	5	6	8	10	12
B(mm)	8	10	12	16	20	24
C(mm)	32	39,5	48	64	80	96
Working load (kg)	90	100	150	250	500	600

\*Surface: E.P, Body: Casting, Pin: Forging

\*Recommended working load "R.W.L." is 1/4 of "T.D.L." tested deformation load. (Surface E.P.= Electro polished)

Shackle, Twist Type, AISI 316

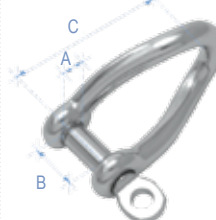

Code	91222	91223	91224	91225	91226	91227
Size (mm)	4	5	6	8	10	12
A(mm)	4	5	6	8	10	11,8
B(mm)	8	10	13	16	20	25
C(mm)	24	30	35	47	52	57
Working load (kg)	200	450	650	1000	1400	2500

\*Surface: E.P, Body: Casting, Pin: Forging

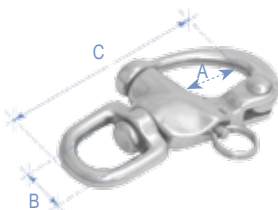

Snap Shackle, with Swivel, Inox 316

Code	91329	91330	91331
A(mm)	12	16	22
B(mm)	12	16	22
C(mm)	70	87	123
T.D.L.*	1900	2900	3900

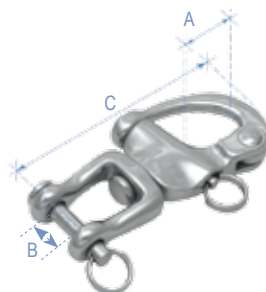

Snap Shackle, with Casting Swivel Jaw, AISI 316

Code	90439	91722	91723
Τύπος	No. 1	No. 2	No. 3
A(mm)	12	16	22
B(mm)	12	12	16
C(mm)	69	90	128
Working Load (kg)	362,88	544,32	816,48

\*Surface: E.P, Body: Casting, Pin: Casting

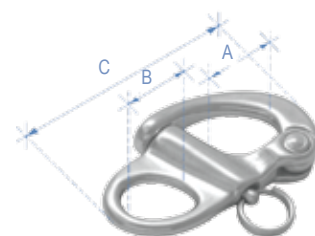

Fixed Snap Shackle, Inox 316

Code	91178	91179	91180
Type	1	2	3
A(mm)	12	15	25
B(mm)	16	21	29
C(mm)	56	70	92,50
T.D.L.*	1,110	2,000	3,500
R.W.L.*	275	500	875

\*Surface: E.P, Body: Casting

# Shackles



Deck Equipment

## Shackle, Shape U, AISI 316

Code	Diameter (mm)	B (mm)	H (mm)	Breaking load (kg)
92701	4	10	15	700
92702	4	12	24	700
92703	5	12	17	1050
92704	5	16	25	1050
92705	5	14	40	1050
92706	5	22	37	1050
92707	6	16	21	2050
92708	6	17	26	2050
92709	6	14	28	2050
92710	6	13	21	2050

## Clevis Pin Shackle, AISI 316

Code	Diameter (mm)	B (mm)	H (mm)	Breaking load (kg)
92713	4	10	15	700
92714	4	12	24	700
92472	4	10	14	600
92480	5	11,5	14,5	800
92715	5	12	17	1050
92723	5	14	40	1050
92716	5	16	25	1050
92717	5	22	37	1050
92718	6	16	21	1050
92719	6	17	26	2050
92720	6	14	28	2050

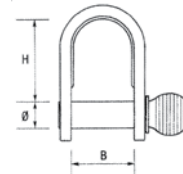

# U-Bolts & Cleats

## Skene Chocks, Inox 316

\*Surface: H.P. - Body: Casting

Surface H.P.= Hand polish

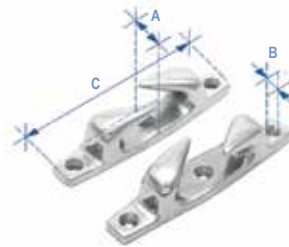

Code	97012	92796	92795	97015
Size (In.)	Right 4 1/2"	Right 6"	Left 4 1/2"	Left 6"
A (mm)	19	34	19	34
B (mm)	5	6	5	6
C (mm)	114	150	114	150

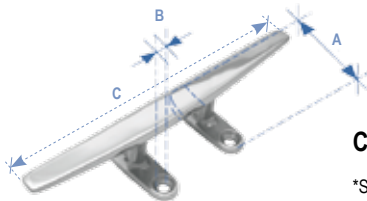

## Cleat, Trim Line, Inox 316

\*Surface: H.P. - Body: Casting

Code	96970	96971	92797	92798
Size (In.)	4"	5"	6"	8"
A (mm)	36	46	53	68
B (mm)	4,5	5,5	6,5	6,3
C (mm)	100	125	150	200

Surface H.P.= Hand polish

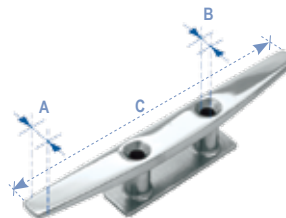

## Cleat, Blue Water, Inox 316

\*Surface: H.P. - Body: Casting

Code	97010	97013	97016	97018	97021
Size (In.)	4"	5"	6"	8"	10"
A (mm)	8	9	12	15	16
B (mm)	4,5	5,5	6,5	8,5	
C (mm)	100	125	150	200	250

Surface H.P.= Hand polish

**Cleat, Pull-up, Inox 316**

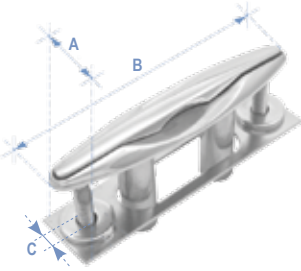

\*Surface: H.P. - Body: Casting

Code	96877	96878	96879
Size (In.)	4,5"	6"	8"
A (mm)	30,5	38	50,8
B (mm)	121,6	160	214,3
C (thread)	5/16"-18	3/8"-16	

Surface H.P.= Hand polish

**Cleat, AISI 316**



Code	93548	93549
Length (mm)	200	238
Height (mm)	70	85
Base (mm)	170 x 70	200 x 65

**Cleat, Open-base, Inox 316**

\*Surface: H.P. - Body: Casting

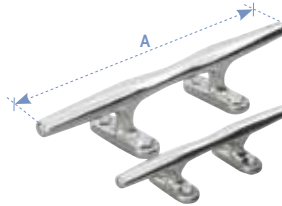

Code	92800	92801	92802	92803	92804
A (mm)	125	150	200	250	305

\*Recommended working load "R.W.L." is 1/4 of "T.D.L." tested deformation load. (Surface E.P.= Electro polished)

**Cleat, Inox 316**



Code	A (mm)	B (mm)	C (mm)	D (mm)	E (mm)	F (mm)
93286	150	45	10,5	30	47	89,5
93287	205	55	15	35	69	120
70641	300	85	22	50	83	160

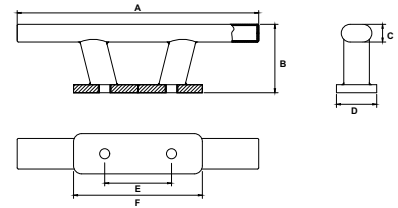

**Bollard, Inox 316**



Code	70640
Length (mm)	120
Height (mm)	95
Width (mm)	120
Diameter (mm)	60



**U Bolt, Inox 316, with Thread**

Code	Thread	A (mm)	B (mm)	C (mm)	D (mm)
91364	M6	32	60	54	5
91365		35	80	74	5
91366	M8	35	80	72	6
91367	M10	35	60	50	8
91368		35	80	70	8
91369		45	100	90	8
91370	M12	45	130	120	8
91371		50	90	78	10
91372		50	130	118	10
91373	M14	60	155	140	12

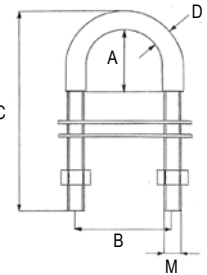

**Jib Sheet Cleat, Polyamide**

Code | 16881

A (mm)	B (mm)	C (mm)	D (mm)	E (mm)
150	24	14	35	6

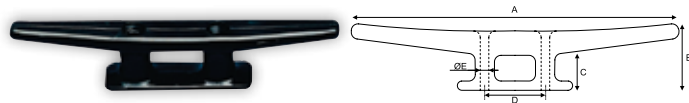
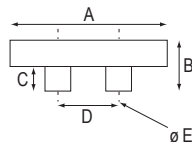

**Cleat, Polyamide**

Code	Colour	A (mm)	B (mm)	C (mm)	D (mm)	E (mm)
43377	White	60	14	9	19	Ø 3
43378	Black					Ø 3
43380	White	80	16	9	21	Ø 4
43381	Black					Ø 4
43383	White	107,5	22	16	29	Ø 5
43384	Black					Ø 5
43386	White	142	29	20	34	Ø 6
43387	Black					Ø 6
43389	White	176	35	23,5	43	Ø 7
43390	Black					Ø 7
43392	White	209	45	29	54	Ø 8,5
43393	Black					Ø 8,5



**Fairlead Handed Polyamide, Black (pair - left, right)**

Code	44417	44420
Dimensions (m)	110 x 20	160 x 25



Deck Equipment

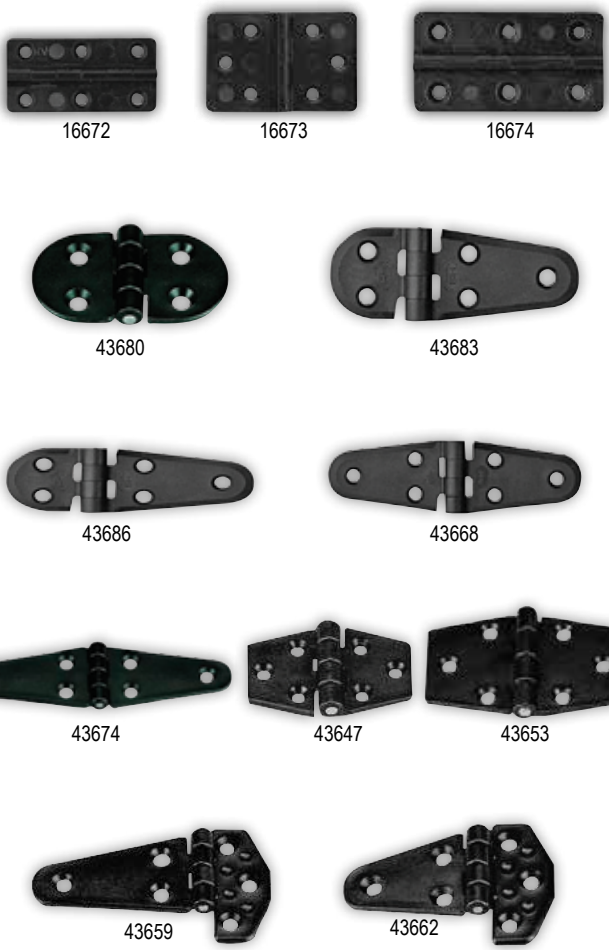

## Polyamide Hinges

Code	Colour	Description	Pin	L (mm)	H (mm)	Thickness (mm)	Opens Through	Material
16672	Black	Rectangular	St. Steel	30	60	-	255°	Polyamid
16673	Black			60	40		255°	
16674	Black			40	75		230°	
43679	White	Round		70	40	4.5 mm	270°	
43680	Black							
43682	White	Semi Oval		90				
43683	Black							
43685	White							
43686	Black	Double Oval		100				
43667	White							
43668	Black							
43673	White	Hexagonal		135				
43674	Black							
43646	White							
43647	Black	Hexagonal	63					
43652	White							
43653	Black							
43658	White	Offset	95	60				
43659	Black							
43661	White							
43662	Black							



### Hinge, Inox 316

Code	Description	A (mm)	B (mm)	C (mm)	D (mm)	E (mm)	F (mm)	Thickness (mm)
70648	Reversed	74	-	39,5	38,1	19,8	5,4	2
70650		47	37,9	20,8	30	21	4,2	1,5
70649	Right	74	-	39,5	38,1	19,8	5,4	2
70651		47	37,9	20,8	30	21	4,2	1,5

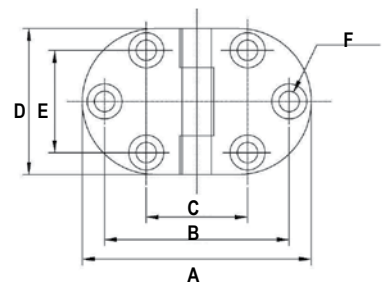

### Hinge, Right, Inox 316

Code	A (mm)	B (mm)	C (mm)	D (mm)	E (mm)	Thickness (mm)
70652	35,7	25,4	37	23	5,4	2
70654	49	31,5	38	22,2	8	2

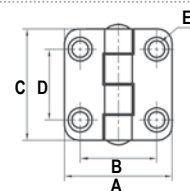

### Hinge, Right with Angle, Inox 316

Code	A (mm)	B (mm)	C (mm)	D (mm)	E (mm)	F (mm)	Thickness (mm)
70653	35,3	23	36,5	22,2	5,4	10	2

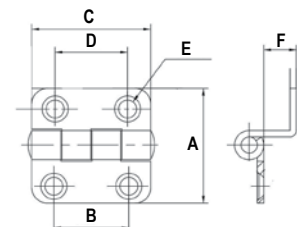

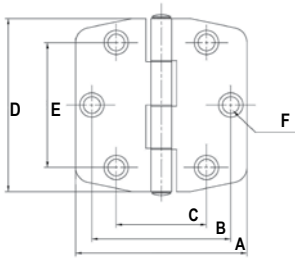

Hinge, Right, Inox 316

Code	A (mm)	B (mm)	C (mm)	D (mm)	E (mm)	F (mm)	Thickness (mm)
70655	74	60	39	75	54	7,2	2
70656	64	50	30	60	39	5,2	2

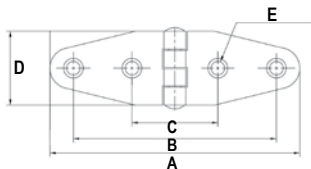

Hinge, Inox 316

Code	Description	A (mm)	B (mm)	C (mm)	D (mm)	E (mm)	Thickness (mm)
70657	Right	101,6	82,5	34,9	30	5,4	2
70659		143	111	40,9	38,1	5,4	2
70658	Reversed	101,6	82,5	34,9	30	5,4	2

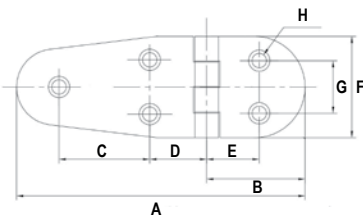

Hinge, Right, Inox 316

Code	A (mm)	B (mm)	C (mm)	D (mm)	E (mm)	F (mm)	G (mm)	H (mm)	Thickness (mm)
70660	108,8	37	34,1	21,4	19,75	38,1	19,8	5,4	2

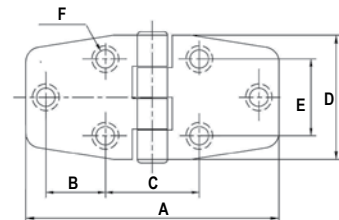

Hinge, Inox 316

Code	Description	A (mm)	B (mm)	C (mm)	D (mm)	E (mm)	F (mm)	Thickness (mm)
70663	Reversed	76	28,2	17,9	37	23	5,4	2
70664	Right							

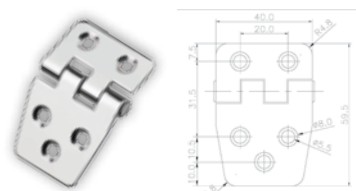
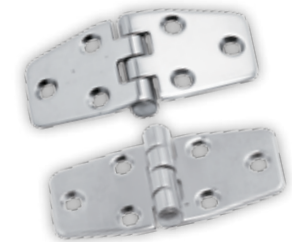

Hinge, Reversed, Inox 316

Code	70661
Length (mm)	55
Width (mm)	38
Thickness (mm)	1,5

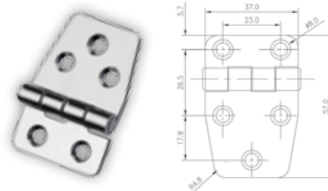

Hinge, Right, Inox 316

Code	70662
Length (mm)	54
Width (mm)	38
Thickness (mm)	2

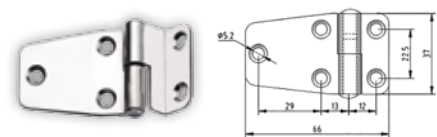

Hinge, Right with Angle, Inox 316

Code	70665
Length (mm)	70
Width (mm)	39
Thickness (mm)	1,5
Angle Height (mm)	9

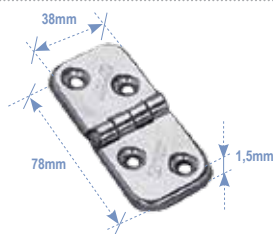

Hinge, Inox 316

Code | 96103



Locking Hasp,  
L.77mm, W.30mm

Code | 99592



Safety Eye Hasp,  
Inox 304, 99 x 25mm

Code | 99591

Deck Equipment

## STANCHION Cover, Clip-on

Clip-on STANCHION Cover is a unique flexible stanchion cover, which provides ideal protection for all bow sails. It is made with Flexible Integral PU Skin Foam technology. STANCHION prevents from chafing of the genoa caused by constant rubbing against the stanchions. It has easy fitting, with 2 nylon clips included.



○ 197757

L (mm)	H (mm)	W (mm)	(kg)
100	70	34	0,06



## SAIL DEFENDER Lifeline Cover, Clip-on

Unique flexible lifeline cover to fit all pulpit in line with the lifeline. Provides ideal protection for all bow sails. Flexible integral skin foam technology. Easy to fit with 5 nylon clips included.



○ 197759

L (mm)	H (mm)	W (mm)	(kg)
320	70	45	0,21



Deck Equipment

## Inox Tube



Code	10420	10421
Description	Inox 316	Inox 304
Diameter (mm)	25	25
Thickness (mm)	1	1
Length (m)	3	3



## Round Base 60°, Inox 316, Base Ø54mm

Code	70608
Diameter (mm)	25



## Round Base 90°, AISI 316, Base Ø54mm

Code	70616	70615
Diameter (mm)	22	25



## Round Base 45°, AISI 316

Code	98080	98081
Diameter (mm)	22	25



## Round Base 60°, Casted, AISI 316, Inter. Ø 22mm

Code	92838	92839
Diameter (mm)	22	25



## Round Base 90°, Casted, AISI 316, Inter. Ø 22mm

Code	92829	92830
Diameter (mm)	22	25



## Rectangular Base 90°, Casted, AISI 316, Inter. Ø 22mm

Code	92832	92833
Diameter (mm)	22	25



## Rectangular Base 60°, Casted, AISI 316

Code	92831	98082
Diameter (mm)	22	25



## Rectangular Base 45°, AISI 316

Code	98083	98084
Diameter (mm)	22	25



## 3-way Corner Fitting, AISI 316

Code	98087	98088
Diameter (mm)	22	25



## Elbow 90°, Casted, AISI 316

Code	92836	92837
Diameter (mm)	22	25



## Tee 90°, Casted, AISI 316

Code	92834	92835
Diameter (mm)	22	25



## Tee 60°, Right Hand, AISI 316

Code	98085	98086
Diameter (mm)	22	25



**Rectangular Base with Inclination 90°, Inox 316, Ø25mm**

Code | 95881



**Round Base 90°, Inox 316, Ø25mm**

Code | 95882



**Rectangular Base with Inclination 60°, Inox 316, Ø25mm**

Code | 95880



**T Connection 90°, Inox 316, Ø25mm**

Code | 70618



**T Connection 60°, Inox 316, Ø25mm**

Code | 70617

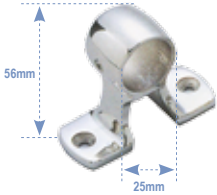

**Fitting for Rails, Central Cap 90°, Inox 316**

Code | 96893  
Size (In.) | 1 (25mm)

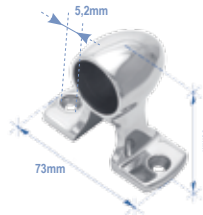

**Rail Fitting, Top Side Cap 90°, Inox 316**

\*Surface: H.P. - Body: Casting  
\*Surface H.P.= Hand polish

Code | 96892  
Size (In.) | 1



43246

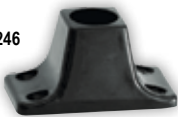

**Rectangular Socket, for Tube Ø22mm, Plastic, Black**

Code	Base Dimensions (mm)	Diameter (mm)	Model
43246	74x39x38	22	90°
43247	89x39x44		60°

43247



44051

**T-Fitting for Rails, Black**

Code	Model	For tube Ø (mm)
44051	T 90°	22
44052	T 60°	

44052



**Net for Bow Rail and for Beds, 25mm Holes**

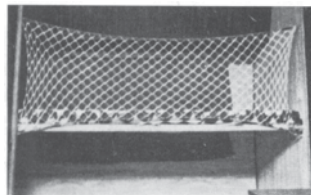

Code | 98289

\* Sold by linear meter

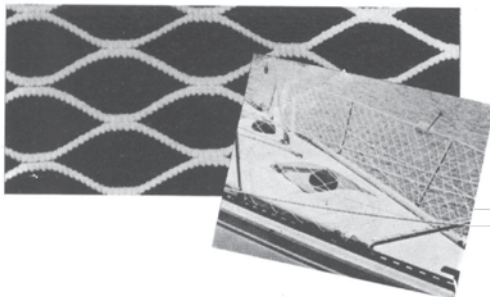

**Net for Bow Rail and for Beds "Standard"**

Made of polyester fibre, resistant to the salt-water. Suitable for protecting the sails on the boats. Size of meshes 25mm. The length showed in our catalogue is in relation to a height of about 20cm. The net can be extended to a height of 60cm, reducing consequently the length.

Code | 98288

\* Sold by linear meter

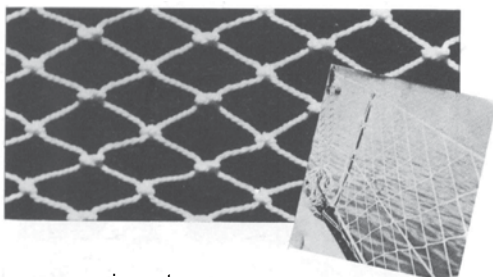

**Net for Bow Rail and for Beds "Extra"**

Made of polyamide fibre, resistant to the salt-water. Suitable for protecting sails and people on the boats. Size of meshes 25mm. The length showed in our catalogue is in relation to a height of about 20cm. The net can be extended to a height of 60cm, reducing consequently the length.

Code | 98287

\* Sold by linear meter





**Marine Padlock**

- Chrome plated brass body
- Stainless steel shackle & springs for maximum resistance to corrosion from sea water & sun
- Automatic return of the key to extraction position
- Key withdrawal with open or closed shackle - Available in blisters of 1, 3 and 5 padlocks
- In the set of 3 or 5 padlocks, all the padlocks unlock with the same key

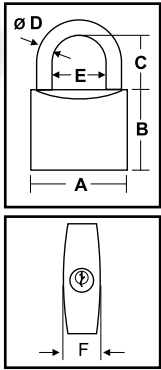

Code	Standard shackle					Long shackle				Set of 3 Padlocks 30mm with joint key	Set of 3 with long shackle, 30mm, with joint key	Set of 5 Padlocks 30mm with joint key
	11134	11135	11136	11137	11138	11139	11140	11141	11142	11143	11906	11905
A(mm)	25	30	40	50	60	25	30	40	50	30	30	30
B(mm)	24	29	33	40	45	24	29	33	40	29	29	29
C(mm)	16	21	23,5	29	31	24	30	41	75	21	30	21
D(mm)	4	5	6	8	9	4	5	6	8	5	5	5
E(mm)	13	15	20	26	32,5	13	15	20	26	15	15	15
F(mm)	12	13	14,5	17	18	12	13	14,5	17	13	13	13

Deck Equipment

**Lock for Hatches, Inox, Ø 12 mm**

Code | 10274

**Hatch Fastener, Inox 316**

Code	70611
Dimensions (mm)	26 x 79

**Safety Lock for Outboard Engines, Inox 316**

For lock of Ø 8mm

Code	99525	99526
Length (mm)	235	280

**Lock and Keys for Deck Hatches TOP LINE/MID LINE/CLASSIC**

Ø 12mm

Code | 44813

**Lock and Keys for Inspection Hatches**

Ø 18,6mm

Code | 44810

**Door Fastener, Plastic**

Code	Colour	Material	Dimensions (mm)
43791	Black	Nylon	22 x 32
13872	White		



**Store-All Utility Hook, Set of 2 pcs**

Ideal for multiple uses on board. You can place it on a flat surface of your boat and use it to tie lines, hang clothing or towels, etc. It is available in a pack of two, in white and graphite colour. Made of plastic.

Code	94126	99231
Colour	White	Graphite
Length (cm)	2.5	2.5
Height (cm)	7.5	7.5
Width (cm)	3	3



**Anti-rattle Barrel Bolt**

Code	Colour	Material	Dimensions (mm)
43851	White	Plastic	(25+60) x 30 x 13



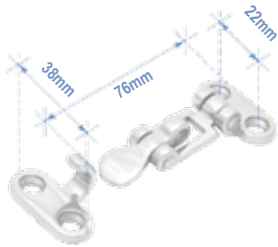

**Cover Latch, Inox 316**

Code	97008
Size (In.)	3

\*Surface: E.P. - Body: Casting  
\*Surface E.P.= Electro polished



**Hatch Fastener, Chrome Plated Brass**

Code	99070
Height (mm)	100
Breadth (mm)	30
Diameter (mm)	6.5

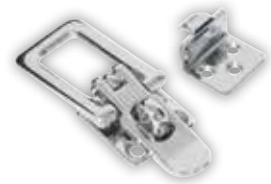

**Hatch Fastener, Chrome Plated Brass**

Code	99071
Height (mm)	100
Breadth (mm)	30
Diameter (mm)	6.5



**Spring Fender Hook, Inox 316**

Code	97024	97025
Size (mm)	38	41



**Barrel Bolt, Chrome Plated Brass**

Code	99977	99978	99979
Length (mm)	50	80	100



**Barrel Bolt, Chrome Plated Brass**

Code	99980
Length (mm)	80



**Barrel Bolt, Inox 316**

Code	99985
Length (mm)	76



**Elbow Catch for Hatch, Brass**

Code	99804
------	-------

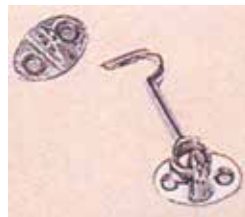

**Cabin Hook, Brass Chrome Plated**

Code	99814	99815	99816
Length (mm)	50	100	150

Deck Equipment

Handles & Handrails



**Handle for 90°-180° Inspection Hatch**

Code	Colour
44197	White
44198	Grey
47737	Cream



**Handles for EURO 2 Hatch, Set**

Code	44208
------	-------



**Handle for TOP LINE/MID LINE/CLASSIC Hatches**

Code	Colour
44206	White
44207	Grey
47738	Cream
196494	Chromed
198133	Black



**Handle for EURO 1 Hatch**

Code	195425
------	--------



**Handles for EURO 38 & EURO 57 Hatches, Set**

Code	195540
------	--------



**Finger Flush Pull Handle, Plastic**

Code	Colour	Dimensions (mm)	Finger hole Ø (mm)
44227	White	57 x 57	44
47752	Cream	57 x 57	44



**Handrail, Inox**

Code	Length (mm)	Diameter (mm)
44209	475	22
44210	625	

## Handles & Handrails



**Handrail, Inox 316**

Code	97686	97687	97688	97689
Diameter (mm)	22			
Length (mm)	300	500	650	850



**Handrail, Shape Π, Inox 316**

Code	93508	93509	93510
Width (mm)	25		
Length (mm)	300	400	500



**Knob for Door, Inox 316, L.205mm, H.55mm, M6**

Total Height: 55mm, Base Length: 205mm, Base Width: 40mm, Thickness: 2,5mm

Code | 70642

**Flush Lift Ring, Stamped, Inox 316**

Code	98718
Dimensions (mm)	56 x 66



**Flush Lift Ring, Stamped, Inox 316**

Code	98719
Dimensions (mm)	76 x 57



**Ring Pull, Chrome Plated Brass**

44mm x 38mm x 13mm (L x W x H)

Code | 99817



**Ring Pull, Brass Polished**

44mm x 38mm x 13mm (L x W x H)

Code | 99818



**Handle, Chrome Plated Brass**

Code	99084
Length (mm)	122
Breadth (mm)	33
Height (mm)	29



**Handle/Step, Plastic**

Code | 90372



**Handle for Hatch, Left (Set)**

Code | 70934



**Handle for Hatch, Right (Set)**

Code | 71213



## Screws, Nuts & Washers



**Screws, Nuts, Inox 316**

SEA WARE range of screws, nuts, bolts and other accessories, are especially designed for the marine industry. Made of Inox 316 for great resistance against the marine environment and weather conditions. All products feature top quality, fine surface finishes and high durability for long time use. For your convenience, the screws, nuts and all the marine accessories are available in blister sets.



**BLISTER (Small quantity)**

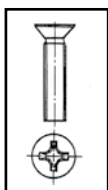

**Countersunk Head Screw, Cross Slotted, Inox 316, DIN 965/ISO 7046**

Code	11195	11196	11197	11198	11199	11200	11201	11202	11203	11204	11205	11206
Dimensions(mm)	3x12	3x16	3x20	3x25	4x16	4x20	4x25	4x30	4x35	4x40	5x16	5x20
Quantity (pcs)	25	25	20	20	20	16	15	15	10	10	10	12

Code	11207	11208	11209	11210	11211	11212	11213	11214	11215	11216	11217
Dimensions(mm)	5x25	5x30	5x40	5x50	5x60	6x25	6x30	6x40	6x50	6x60	6x70
Quantity (pcs)	10	8	6	4	4	6	6	5	4	3	2

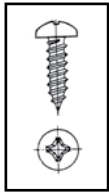

## Plain Recessed-head Self-tapping Screw, Inox 316, DIN 7981/ISO 7049

Code	11218	11219	11220	11221	11222	11223	11224	11225	11226	11227	11228	11229	11230	11231
Dimensions(mm)	2,9x9,5	2,9x13	2,9x16	2,9x19	2,9x25	3,5x9,5	3,5x13	3,5x16	3,5x19	3,5x25	3,5x32	4,2x9,5	4,2x13	4,2x16
Quantity (pcs)	20	20	20	20	20	20	20	20	20	20	16	20	20	20
Code	11232	11233	11234	11235	11236	11237	11238	11239	11240	11241	11242	11243	11244	11245
Dimensions(mm)	4,2x19	4,2x25	4,2x32	4,2x38	4,2x50	4,8x16	4,8x19	4,8x25	4,8x32	4,8x38	4,8x50	5,5x19	5,5x25	5,5x32
Quantity (pcs)	15	15	15	10	8	15	15	12	10	8	7	10	8	7
Code	11246	11247	11248											
Dimensions(mm)	5,5x38	5,5x50	5,5x60											
Quantity (pcs)	6	4	4											

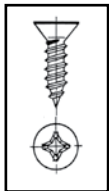

## Countersunk Screw, Slotted-head, Self-tapping, Inox 316, DIN 7982/ISO 7050

Code	11249	11250	11251	11252	11253	11254	11255	11256	11257	11258	11259	11260	11261	11262
Dimensions(mm)	2,9x9,5	2,9x13	2,9x16	2,9x19	2,9x25	3,5x9,5	3,5x13	3,5x16	3,5x19	3,5x25	3,5x32	4,2x9,5	4,2x13	4,2x16
Quantity (pcs)	20	20	20	20	20	20	20	20	20	20	16	20	20	20
Code	11263	11264	11265	11266	11267	11268	11269	11270	11271	11272	11273	11274	11275	11276
Dimensions(mm)	4,2x19	4,2x25	4,2x32	4,2x38	4,8x16	4,8x19	4,8x25	4,8x32	4,8x38	4,8x50	5,5x19	5,5x25	5,5x32	5,5x38
Quantity (pcs)	20	20	15	10	15	15	15	12	10	8	10	8	8	6
Code	11277	11278												
Dimensions(mm)	5,5x50	5,5x60												
Quantity (pcs)	4	4												

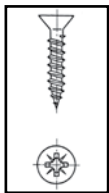

## Chipboard Screw, Countersunk Recessed-head, Inox 316

Code	11308	11309	11310	11311	11312	11313	11314	11315	11316	11317	11318	11319	11320	11321
Dimensions(mm)	3x16	3x20	3x25	3x30	3,5x16	3,5x20	3,5x25	3,5x30	4x20	4x25	4x30	4x35	4x40	4x50
Quantity (pcs)	30	25	25	20	20	25	20	20	20	16	15	15	15	12
Code	11323	11324	11325	11326	11327	11328	11329	11330	11331	11332				
Dimensions(mm)	4,5x30	4,5x35	4,5x40	4,5x50	5x30	5x40	5x50	5x60	5x70	5x80				
Quantity (pcs)	12	10	10	10	12	8	7	6	6	5				

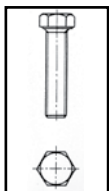

## Bolt, Hexagon Head, Fully-threaded, Inox 316, DIN 933/ISO 4017

Code	11333	11334	11335	11336	11337	11338	11339	11340	11341	11342	11343	11344	11345	11346
Dimensions(mm)	4x10	4x20	4x30	5x16	5x20	5x25	5x30	5x40	5x50	6x16	6x20	6x25	6x30	6x35
Quantity (pcs)	20	15	10	8	8	7	6	5	4	7	5	4	4	4
Code	11347	11348	11349	11350	11351	11352	11353	11354	11355	11356	11357	11358	11359	
Dimensions(mm)	6x38	6x40	6x45	6x50	6x60	8x20	8x30	8x40	8x50	10x30	10x40	10x50	10x60	
Quantity (pcs)	4	4	3	3	2	2	2	2	1	1	1	1	1	

## Hexagon Nut, Inox 316, DIN 934/ISO 4032

Code	70170	70171	11362		
Dimensions(mm)	M3	M4	M5		
Quantity (pcs)	20	20	20		
Code	11363	11364	11365		
Dimensions(mm)	M6	M8	M10		
Quantity (pcs)	15	8	3		

## Hexagon Nut, Self-locking, Inox 316, DIN 985/ISO 10511

Code	11366	11367	11368		
Dimensions(mm)	M3	M4	M5		
Quantity (pcs)	10	10	10		
Code	11369	11370	11371		
Dimensions(mm)	M6	M8	M10		
Quantity (pcs)	10	6	3		

## Hexagon Nut, Grommet, Inox 316, DIN 1587

Code	11378	11379	11380		
Dimensions(mm)	M3	M4	M5		
Quantity (pcs)	8	8	6		
Code	11381	11382	11383		
Dimensions(mm)	M6	M8	M10		
Quantity (pcs)	5	3	2		

## Flat Washer, Inox 316, DIN 125/ISO 7089

Code	11390	11391	11392		
Dimensions(mm)	M3	M4	M5		
Quantity (pcs)	50	30	30		
Code	11393	11394	11395		
Dimensions(mm)	M6	M8	M10		
Quantity (pcs)	20	20	15		

## Screws, Nuts & Washers



### Washer for Screw, Plastic Grommet only



Code	Colour	Diameter Ø (mm)
44977	White	3.5
44983		4.5
44989		5.5
44978	Black	3.5
44984		4.5
44990		5.5

Set of 3



### Windshield Spacer & Screw Cap

Code	Colour	Description
43835	White	Spacer. Ø overall 20 - overall height 10 - Ø hole 7 mm
43836	Black	

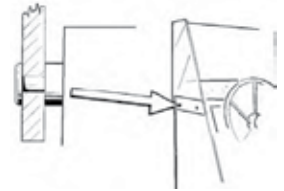

## Pilot Seats & Pedestals



### Pairing Seat with Base

**Step 1:** Select the seat of your liking

**Step 2:** Using the following table, select one of the bases which corresponds to the seat of your choice

**Step 3:** Using the colours of the following table, check whether the use of any additional component is necessary or not

		Seats										
		Code	90095	90113	90108	99801	90128	90115	90112	90096	99579	90129
Bases	90136	•	•	•	•	•	•	•	•	•	•	•
	90130	•	•	•	•	•	•	•	•	•	•	•
	90134	•	•	•	•	•	•	•	•	•	•	•
	90135	•	•	•	•	•	•	•	•	•	•	•
	90137	•		•			•	•	•	•		•
	99519	•	•	•	•				•			
	99581	•	•	•	•				•			
	99582	•	•	•	•				•			
Additional Components	90131	Necessary to use 90131 (page 220) with the corresponding set of seat - base										
	90133	Necessary to use 90133 (page 220) with the corresponding set of seat - base										
	90131	Optional use of 90131 (page 220) with the corresponding set of seat - base										



### Admiral Chair, with Full Cushion, Graphite

Height 43 cm x Width 48 cm x Depth 43 cm

Code | 90095



### First Mate Cushion Chair, White

Height 38 cm x Width 44,5 cm x Depth 39 cm

Code | 90113



### Skipper Fold-down Chair Shell

Height 45,5 cm x Width 49,9 cm x Depth 43 cm

Code | 90108



### Cushion for Skipper Seat, Light Grey

Code | 90109



**Traveller Fold-down Chair Shell, with Cushions, Grey**

Height 35,5 cm x Width 51 cm x Depth 45,5 cm

Code | 99801



**Deluxe Captain Chair, White**

Height 48 cm x Width 63,5 cm x Depth 58,5 cm

Code | 90115



**Skipper Chair with Cushion, Light Grey/Dark Grey**

Code | 90112



**Yachtsman Chair, with Cushion, White**

Height 43 cm x Width 48 cm x Depth 45,5 cm

Code | 90128



**Admiral Seat Shell, with Mounting Plate**

Height 43 cm x Width 48 cm x Depth 43 cm

Code | 90096



**First Mate Chair Shell**

Height 38 cm x Width 44,5 cm x Depth 39 cm

Code | 99579



**Yachtsman 2 Chair**

Height 43 cm x Width 48 cm x Depth 45,5 cm

Code | 90129



**Folding Chair, White**

Height 48,26 cm x Width 40,64 cm x Depth 48,26 cm

Code | 72106



Deck Equipment



**Columbia Seat Pedestal, Fixed**

Code | 90136



**Columbia Seat Pedestal, with Adjustable Height 352-428 mm**

Code | 90130



**Columbia Seat Pedestal, with Slide**

Code | 90137



**Seat Swivel, with 12 Locking Positions**

Code | 90133



**Seat Swivel Base, 174 mm x 174 mm**

Code | 99580

**Trac-Lock II Chair Slide**



Code | 90131

**Belle Seat Pedestal, with Adjustable Height 330-432 mm**

Code | 90134\* | 90135

\*with swivel locking



## Pilot Seats & Pedestals



### Pedestal

Fixed

Code	99581	99582
Height (mm)	178	330

With Swivels

Code	99583	99584
Height (mm)	178	330



### Seat Base, Telescopic, Inox 316

Diam: 60mm, H: 450mm

Code | 99519

## Buoyant Deck Cushions

### Buoyant Deck Cushions

Buoyant Deck Cushions are equipped with waterproof outer material and filled with polyethylene foam. There are integral straps around the cushions, so as to carry them easily and quickly. The cushions lock on your boat through a nylon hook at their back. They are either single or double, depending on your needs and come in white, red and blue colour. White cushions are made of PVC, while red and blue cushions are made of polyester with PVC overlay. It is recommended to clean the cushions with cold fresh water.

Code	Deck Cushion	Colour	Material	Buoyancy (kg)	Weight (kg)
11511	Single	White	PVC	9,5	0,6
11512	Double			19,5	1,25
11513	Single	Red	Polyester	9	0,55
11514	Double			19	1,20
11515	Single	Blue	Polyester	9	0,55
11516	Double			19	1,20

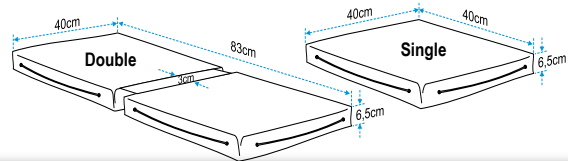

Deck Equipment

## Tables & Pedestals

### Table Top, White



49722



47087



197241



197292

Code	Model	Material	Length (mm)	Width (mm)	Thickness (mm)
49722	Rectangular	Polyethylene	700	500	30
47087	Round	Polyethylene		Ø 600	30
197241*	Round	White ASA, impervious to UV and chemical solvents		Ø 610	40
197292*	Oval	White ASA, impervious to UV and chemical solvents	760	450	40

\*with 2 glass holders

Table Top Plate, Ø190mm - H.55mm, White



Code | 43263

Table Bottom Plate, Deck mounted, Ø190mm - H. 55mm, White



Code | 196163

Table Bottom Plate, Flush mounted, Aluminium, Ø150mm-H.9,5mm



Code | 197291

Table Bottom Plate, Flush mounted, Ø190mm-H.10mm, White



Code | 43261

Clips for Table Pedestals, Set (2 pcs)



Code | 197289



Compatibility Chart

Description	Code	Table Top			
Top Plate	43263	Yes	Yes	-	-
Bottom Plate	Deck Mounted 196163	Yes	Yes	Yes	Yes
	Flush Mounted 43261	Yes	Yes	Yes	Yes
Pedestals	Fixed 44048	Yes	Yes	Yes*	Yes*
	44049	Yes	Yes	Yes*	Yes*
	Telescopic 44060	Yes	Yes	Yes*	Yes*
	44058	Yes	Yes	Yes*	Yes*

\*Screws directly on table top

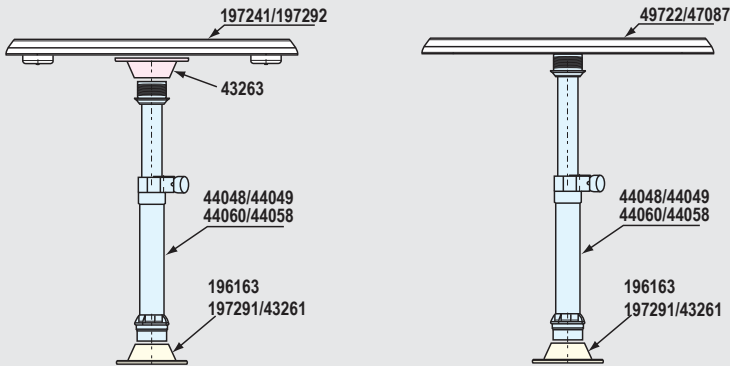
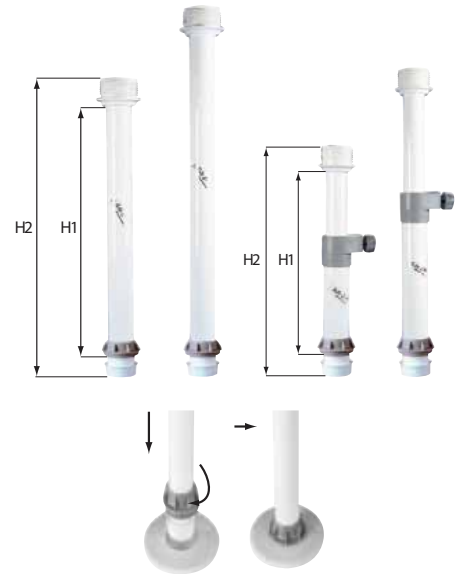

Table Pedestal



Code	Description	Tube Ø (mm)	Height H1 (mm)	Height H2 (mm)
44048	Fixed tube White enamelled aluminium	60	530	610
44049	Fixed tube White enamelled aluminium	60	690	770
44060	Telescopic tube White enamelled aluminium	60	300 / 520	380 / 600
		60	400 / 730	480 / 810



Deck Equipment



Support Bracket for Table, AISI 316, 300 mm x 165 mm x 20 mm

Code | 70633



Table Pedestal, Adjustable Height 547-700mm

Code | 90142



Deck Chairs & Tables

Aluminium Deck Chair, Teak Armrests, Navy Blue



Code | 70936

Aluminium Table with Melamine Top



Code	70939	70941
Dimensions (cm)	44x88x61	60x88x61

Aluminium Table with Melamine Top



Code	70940
Dimensions (cm)	61x61x49

## CHOOSING THE RIGHT CANOPY

When choosing a canopy for your boat you should first ensure that the model is suitable for your type of boat (sail or power). It is also important to ensure that you measure your boat accurately and make sure that adequate fitting space is available.

### Step 1. Calculate the Length (A)

On sailing boats, we recommend the length of the canopy to be equal to the distance between the centre of the companion way steps to a point just beyond the rear of the cockpit. This measurement should reach the backstay without including it. If you prefer a larger canopy, you should make the appropriate modifications in order for the backstay to pass through the canopy. In powerboats the length of the canopy is only defined by your specific requirements and the area of the boat you wish to cover. So, (A1-A2) = Canopy Length

### Step 2. Points of installation

On sailing and powerboats, the points of installation are calculated by dividing the canopy length by 2. i.e.  $A / 2 = \text{Points of Installation } B1 \text{ \& } B2$ . This formula gives you the distance between points A1 or A2 to the point where you should place the canopy. In sailing boats these points should be slightly inboard of the rails to cover the cockpit area. On powerboats the usual installation point is the middle of the gunwale.

### Step 3. Calculate the Width (B)

Measure the distance between installation points. So (B1-B2) = Width. Please note that the width of the canopy is not necessarily the boat's width.

### Step 4. Calculate the Height (C)

Calculate the height of the canopy according to your own requirements. In order to measure the height, just measure the distance from the installation points up to the desired height. On powerboats, the height of canopy should not obstruct navigation lights.



Deck Equipment

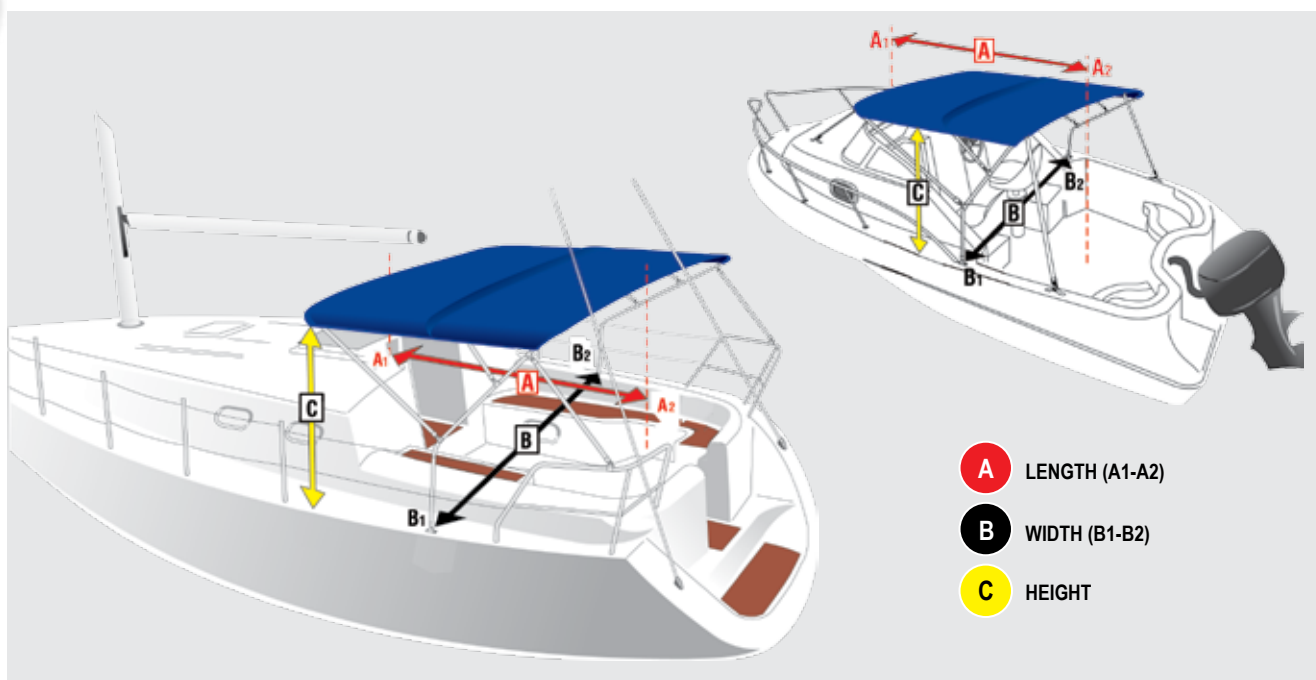

### Canopy "Athens", Inox, Blue

The "Athens" range has been designed to the highest standards. The frame is made of stainless steel for extended life and high resistance to corrosion, while also providing an attractive, polished finish. It is available in various sizes with lengths varying from 180 to 280 cm, width 180 to 280 cm, while the height is adjustable, up to a maximum of 155 cm. The canopy top is made of PVC coated nylon fabric, which is 100% waterproof, UV resistant and is available in a smart blue. Choose the frame whose dimensions fit the nearest to your boat. Follow the above fitting instructions, and enjoy moments of relaxation at sea.

Code	70907	70908	70909	70910	70911
Length(cm)	180	180	180	200	200
Width(cm)	180	230	280	200	215
Height(cm)	155	155	155	155	155

Code	70912	70913	70914	70915	70916
Length (cm)	240	240	240	280	280
Width (cm)	180	230	280	230	280
Height (cm)	155	155	155	155	155



**Complete Solution**





### Canopy Poseidon, Aluminium

The Poseidon series belongs to the new category of professional canopies of single opening, with aluminium tubes, joints and hinges made of polycarbonate material and heavy waterproof fabric that provides protection from UV radiation. All you need to get are the screws.



Code	57320	50461	50462	50463	50464
Colour	White				
A (cm)	180				
B (cm)	130	150	170	190	210
C (cm)	110				

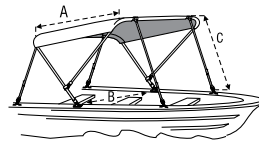

### Canopy Venus, Aluminium

The Venus series follows approximately the same design parameters of the Poseidon series while the main difference is that it has a central support in order to achieve better fastening and better stretching of the fabric. The fabric is waterproof and offers protection against UV radiation.



Code	57321	50481	50482	50483	50484
Colour	White				
A (cm)	180				
B (cm)	130	150	170	190	210
C (cm)	135				



Deck Equipment

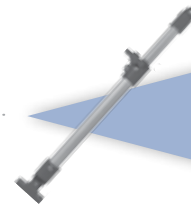

**Combine with**  
Canopy Support Poles  
page 227

### Canopy Zeus, Aluminium

The Zeus series is the series of the largest canopies with aluminium base. It has a quadruple side support and can be folded back so that it can be wrapped with a protective cover. The supports are also made of aluminium and their waterproof fabric provides protection against UV radiation. The canopies Zeus cover an area of more than 5 square meters.



Code	50501	50502	50503
Colour	White		
A (cm)	240		
B (cm)	170	190	210
C (cm)	135		

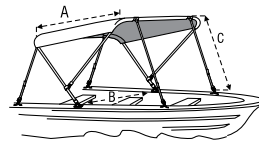

### Canopy Basic, Aluminium

Designed to be used as a canopy on small speedboats and inflatable boats. Easy to set up, quick fold and store when not in use. Made of thick nylon coated PVC and marine grade anodized aluminium, available in white colour and in 4 sizes for the correct adjustment to the width of your boat.



Code	50431	50432	50433	50434
Colour	White			
A (cm)	133	195	235	280
B (cm)	120	140	162	180
C (cm)	105	109	113	117

## Sunshade JOS

JOS sunshade has been designed to offer relief from the sun's penetrating rays anywhere on board. They are made of 420D polyester, with UV protection and are supplied in rectangular and trapezium shape, in order to fit to all boat types. They have been designed in such a way that the air is recycled and not "trapped", making life on board far more pleasant. The texture of the upper part of the shade reflects the sun's rays, while the underside enhances the cool feel with its light blue finish.

"JOS" sunshades are lightweight and can be installed in few minutes, by using the aluminium poles supplied, or alternatively the rectangular poles and the supplied rope for the trapezium shape. For better fit, you can adjust the sunshade to your boat's rails by using the supplied elastic rope. Available in 8 different dimensions and one colour combination (silver/blue).



Deck Equipment

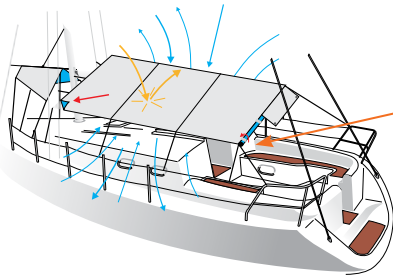

### Rectangular

Code	70896	70897	70898	70899
Dimensions (cm)	260x460	315x370	315x430	350x490

### Trapezium Shape

Code	70900	70901	70902	70903
Dimensions (cm)	80x210x220	80x230x320	80x290x360	80x320x400,5

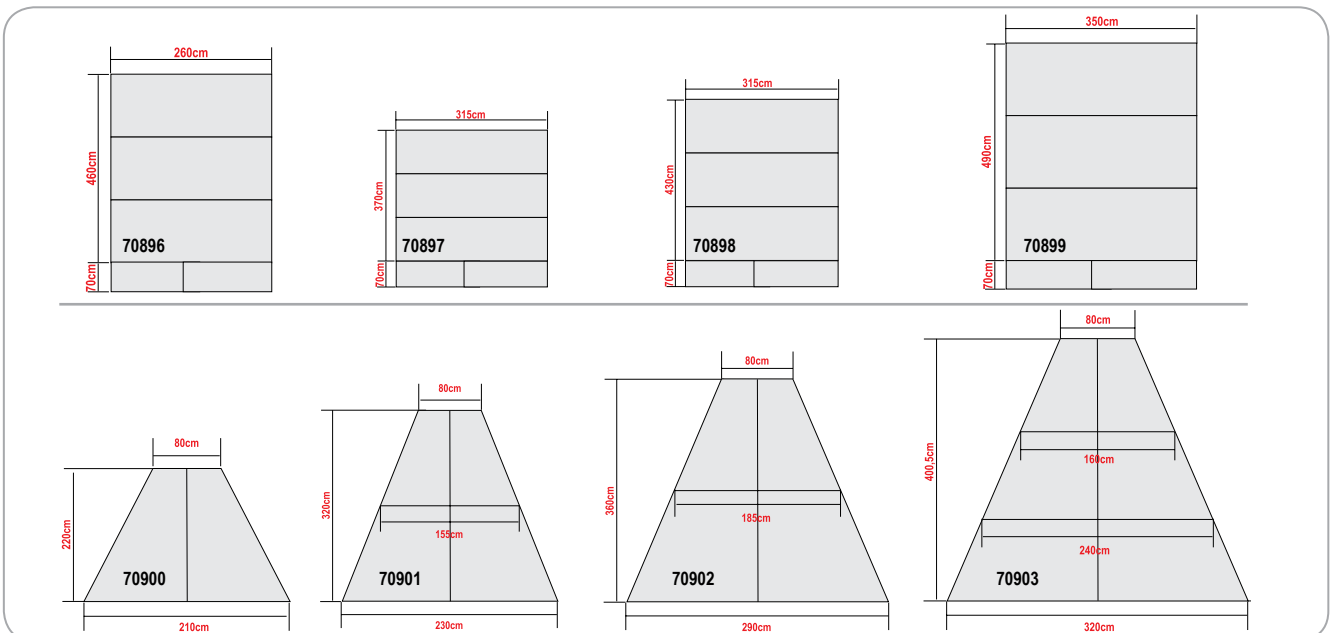
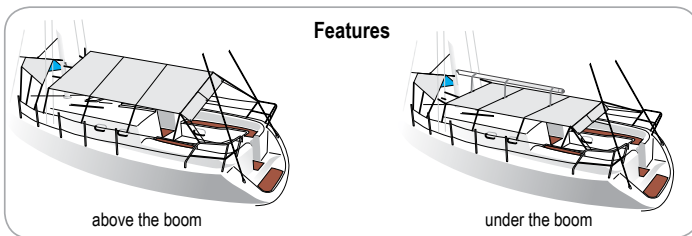
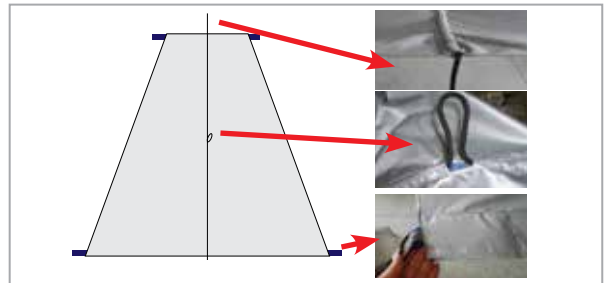
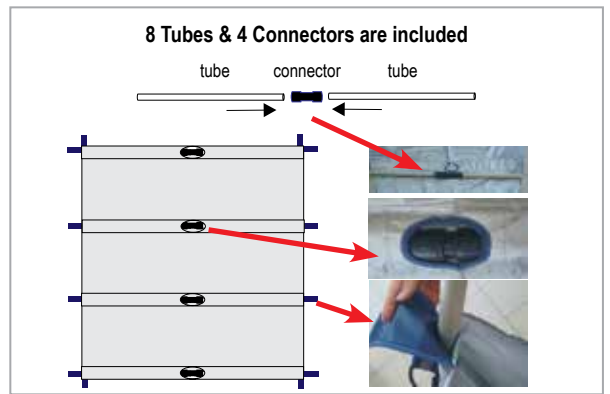



**Hook for Inflatable Boat Cover**

Rope or shock cord Ø 8 mm max.  
Length 40 mm x Height 40 mm

Code	Colour
28112	Black
44015	White
44016	Grey

**Clevis Forks for Bimini Top**



Code	Description
43066	for Bimini Tops Socket 43107, White
43067	for Bimini Tops Socket 43108, Black



**Mounting Clip 10mm for Bimini-Top, Ø25mm Tube**

Code	Colour
35002	Black
43105	White

**Bottom Socket for Bimini Top**



Code	Colour
43107	White
43108	Black



**Mounting Fitting for Bimini-Top Frame**

Code	Colour	For tube Ø (mm)
43091	Black	20
43090	White	
43103	Black	22
43102	White	



**Suction Disc**

Code	Description
43233	Grey suction disc Ø 92 mm
43234	Black suction disc Ø 92 mm



**Mounting Fitting, Bimini-Top Frame, Clamp-on**

Code	Colour	For tube Ø (mm)
43088	Black	20
43087	White	
43100	Black	22
43099	White	



**Mounting Fitting, Bimini-Top Frame, 2-Wings**

Code	Colour	For tube Ø (mm)
43082	Black	20
43081	White	
43094	Black	22
43093	White	



**Mounting Fitting, Bimini-Top Frame, 1-Wing**

Code	Colour	For tube Ø (mm)
43085	Black	20
43084	White	
43097	Black	22
43096	White	



**Rail Fitting (Top Cap), Inox**

Code	50871	96928
Diameter(mm)	25	22



**Deck Hinge, Inox**

Code	50870
Diameter (mm)	25



**Top Slide, Inox**

Code	50872	96930
Diameter(mm)	25	22

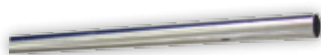

**Tube, Inox 316**

Code	10420	10421
Inox	316	304
Diameter (mm)	25	
Thickness (mm)	1	
Length (m)	3	



**Top Slide, Inox**

Code	50876	50873	57205
Diameter(mm)	32	25	22



Deck Equipment

## Aluminium Canopy Accessories

The range of canopies is complemented by an extensive range of accessories that can be also used to custom build your own canopy. All products are made of durable polycarbonate materials with protection from UV radiation, so as to achieve a longer service life.



### Canopy Socket for Inflatable Boat Ø 22 mm (7/8")

Code | 50550

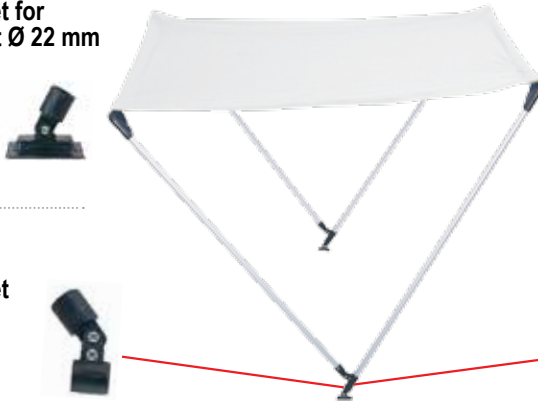

### Canopy Hinge 90°

Code | 50070

### Canopy Socket

Code | 50080

### Canopy Socket

Code | 50090

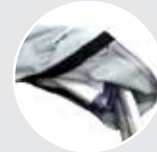

All aluminum canopies are supplied with covers, except for the "Basic" one. The covers for "Athens" Inox canopies are optional.

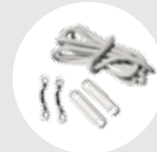

All canopies are supplied with four adjustable straps, apart from the "Athens" model, which has two.

Deck Equipment

### Connector Ø 7/8"

Code | 00249

### Jaw Slide Ø7/8"

Code | 50330

### Deck Hinge

Code | 50320

### Quick Release Deck Hinge

Code | 50380

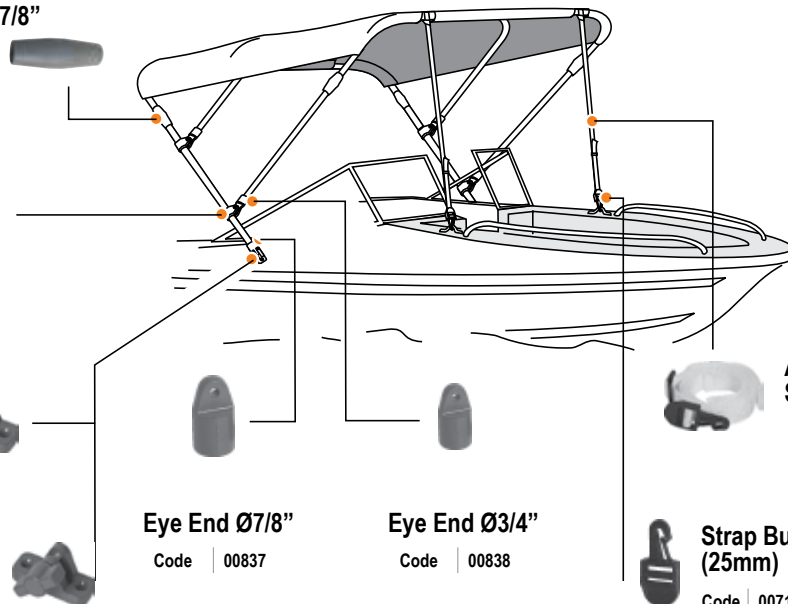

### Eye End Ø7/8"

Code | 00837

### Eye End Ø3/4"

Code | 00838

### Adjustable Strap 25mm

Code | 50350

### Strap Buckle 1" (25mm)

Code | 00716

## Bimini Accessories with Rope, Set (2 pcs)

Code | 71964



Includes:  
2m rope  
2 adjusters  
2 eye strap  
4 screws

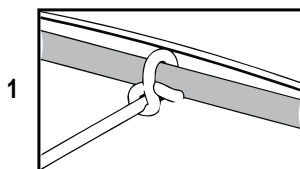

1 Fasten one end of the rope to the bimini tube.

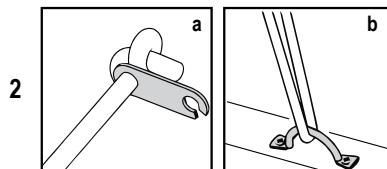

2 Tie the other end of the rope to a knot (a), pass the rope underneath the eye strap (b) and stretch it.

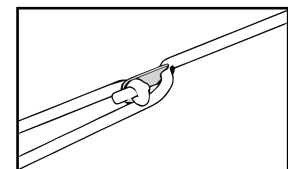

3 Hook the adjuster on the rope so as to remain stretched all the time.

Connector "Cross"



Code | 50875

Cover for Canopy Connector "Cross"



Code | 01834

Deck Hinge, Quick Release, Side mounted



Code | 50680

Deck Hinge, Side mounted



Code | 50681

Deck Hinge Quick Release for Inflatable Boats



Code | 50390

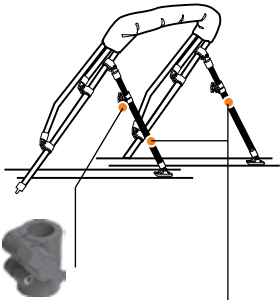

Jaw Slide, Quick Release, Ø 22 mm (7/8")

Code | 50360

Canopy Support Pole 71 to 122cm (28" to 48")



Code | 50340



Webbing

Code	Description
00043	Polyester Webbing 25mm, Thickness 0,9mm, White, (Roll 50m)
02035	Polyester Webbing 25mm - Yellow (Roll 50m)
02262	Polyester Webbing 50mm, Thickness 1,3mm, White (Roll 50m)

Press Stud Socket



Code | 70626

Press Stud with Screw & Nut



Code | 70628

Screwdriver for Press Studs 70626 & 70629



Code | 70631

Press Stud, Twisted



Code | 70627

Press Stud with 2-Hole Screw Base



Code | 70630

Press Stud for Fabric



Code | 70629



Canopy Fabric, Width 150cm

Code	01769
Colour.	Blue

\* Sold by m<sup>2</sup>

Pull Pin, Inox, Pin Ø 6,3mm



Code	99637
Total Length (mm)	194



Washer for Screw, Plastic

Washer only

Code	Colour	Diameter Ø (mm)
44977	White	3.5
44983		4.5
44989		5.5
44978	Black	3.5
44984		4.5
44990		5.5

Twist Stud & Clinch Plate, Ø29mm, 35x17mm, Black



Code | 45358

Cap & Washer for Screw, Plastic

\*Washer with screw cap



Code	Colour	Diameter Ø (mm)
44916	Black	3.5
44914	White	
44923	White	4
44925	Black	4.8

\*screw not included

# Tarpaulin Covers

## Protective Cover – Tarpaulin, Silver

It can be used in various applications such as:

- Cover boats, cars etc.
- Tent on boats
- Cover equipment and machinery stored in outside areas
- Cover painted areas
- Camping
- Swimming-pool cover and many others

### Characteristics:

- Extra strong polyethylene
- Water-resistant and weatherproof
- Re-usable
- Washable
- UV-resistant
- Laminated on both sides for maximum weatherproofing
- 120gr/m<sup>2</sup>

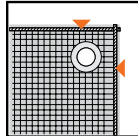

The outer edges are reinforced with rope sealed in hem for extra strength

Code	Dimensions(m)
57227	2 x 1,5
57228	2,5 x 2
57229	3 x 2,5
57230	3 x 3
57231	4 x 2,5
57232	4 x 3
57233	4 x 4
57234	5 x 2,5
57235	5 x 3
57236	5 x 4
57237	5 x 5
57238	6 x 3
57239	6 x 4
57240	6 x 5
57241	7 x 4
57242	7 x 5
57243	7 x 6
57244	8 x 4
57245	8 x 6
57246	9 x 5
57247	9 x 7

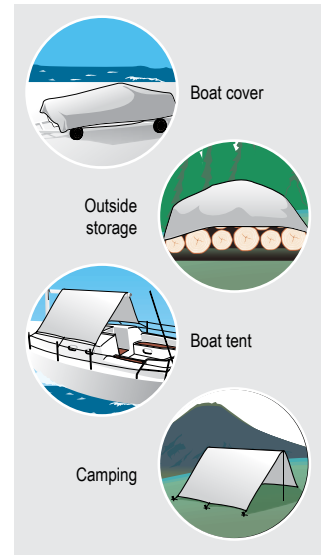

Deck Equipment

## Boat & Engines Covers



### Engine Cover

SEA COVER Engine Covers are ideal for the protection against water, sun and dust. They are made of extra strong polyester 420D, 0,15mm thick for maximum water resistance and UV protection. They are suitable for most types of outboard engines, from 2 to 300hp and are available in two different types. There are the covers suitable only for the top part of the engine (not the shaft) and feature an elastic cord all around for ideal fit to most types of outboard engines. Additionally, there are the full body covers, which feature an elastic cord and a zipper, so as to ensure the best possible engine's protection, including its shaft. You can find 7 different sizes of the covers for the top part of the engine and 3 different sizes for the full body covers. All come in silver colour. The tables below show the different sizes of the covers. The dimensions refer to the length, the width and the height of the cover (Drawing 1). The horsepower given is approximate and it is not the only factor that should be taken into consideration when choosing your cover. The type of the engine (2 stroke, 4 stroke), the length of the throttle grip, the brand of your motor and its production date should also affect your choice, as they differentiate the size of the engine.



### Cover for the Top Part of the Engine

Code	57269	57270	57271	57272	57273	57274	57275
H.P (Approximate)	2-5	2-15	10-45	30-90	70-150	115-225	150-300
A (cm)	40	46	55	63	73	75	90
B (cm)	25	27	33	35	40	45	60
C (cm)	32	35	45	50	65	75	80

### Full Body Engine Cover

Code	57329	57330	57331
H.P (Approximate)	2,5-10	8-70	70-150
A (cm)	75	87	125
B (cm)	125	157	210

To choose the most suitable cover for the top part of your engine, measure it as shown in the Drawing 2 and determine the dimensions that more closely match your model.

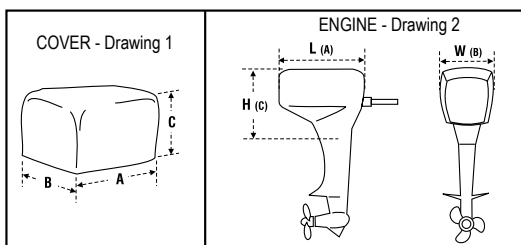

\*When calculating the height of the engine, you should also include a part of the shaft, as shown in Drawing 2, in order to ensure that the engine will be covered completely underneath (apart from the shaft).

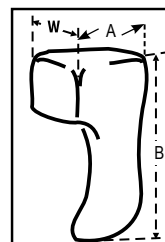

In order to calculate correctly the maximum height that the appropriate cover should have, you should deduct from the engine's height (B) half of its width (W). For instance, if the height (B) of your engine is 210cm and its width (W) is 50cm, then the cover that you need should be 185cm (210cm-25cm) high. Therefore, in this case, the correct cover is cover 57331, which is 210cm high, as indicated in the relevant table.



## Boat & Jet Ski Cover

SEA COVER Boat Cover is ideal to protect your boat against rain, dust and sun. Perfect for storing your boat during winter months and also when in the water but needs to be covered. It combines high manufacturing standards with high-quality materials. It is available in several sizes depending on boat's dimensions. Junior, mini and sizes from 1 to 6 are made of extra strong PA coated polyester 420D for maximum water resistance and they are available in silver colour. Size 7 is made of 600D polyester and available in blue colour. All feature an elastic cord at their total circumference for ideal fit and double stitched seams for long-lasting use. Additionally, they have non-scratching plastic D-rings for extra hull protection. They can be used in fishing or recreational boats, inflatable ones or motorboats with or without cockpit and rails.

Code	57351	57324	74702	57265	57266	57267	57268	57322	57323	57352
Size	Junior	Jet Ski - Mini	Jet Ski - Large	1	2	3	4	5	6	7
Loops	Each Side	2pcs	3pcs				4pcs			
	Back	2pcs	2pcs				2pcs			
	Total	6pcs	8pcs				10pcs			
Colour	Silver								Blue	



Deck Equipment

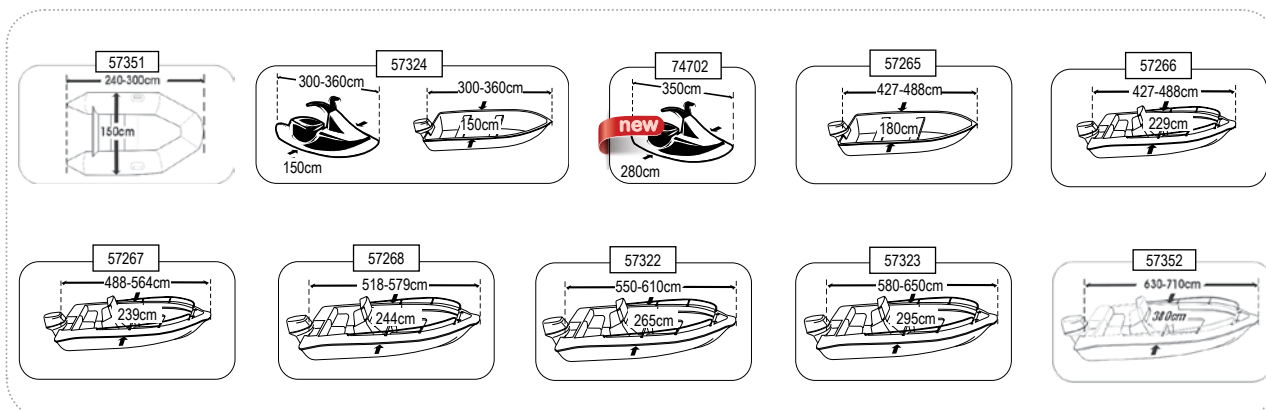

## Console Cover

This console cover is provided in silver colour and in five different sizes. It is made of extra strong Polyester 420D with double stitched seams for long lasting use and it features a cord all around at the bottom side for ideal fit. It also provides superb UV Protection and reduces the damage possibility of instruments and electronics because of weather conditions.

Code	Size	Dimensions (cm)			
		Height (1)	Height (2)	Depth	Width
57355	1	115	90	45	55
57356	2	90	65	75	85
57357	3	120	105	70	65
57358	4	140	100	90	70
57364	5	140	100	90	90

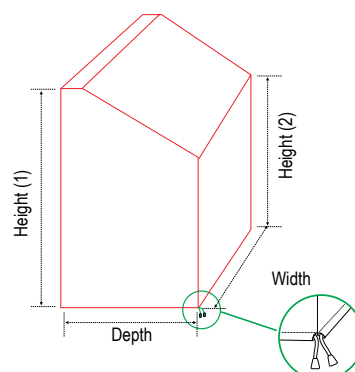

## Boat & Engines Covers



**Laser Boat Cover**

Code | 71296



Code | 70175

### Optimist Hiking Straps, L 1,5m W 5cm

Optimist hiking straps hold sailor's feet when hiking and absorb individuals' shocks from rough sailing. They are made of 600D Polyester with PVC backing. They are filled with NBR foam in the middle for water resistance and pleasant feel. The straps are put together on their one edge, so as to adjust them according to the length of your feet. The straps are loose on their other edge to tie them on your Optimist using a plate or buckle.



### Optimist Boat Cover

It protects your Optimist from heavy wear and prolongs its life. Optimist boat cover drapes the entire dinghy and closes tightly for storage. It is made of heavy duty 600D Polyester with PVC backing and ripstop reinforcement to resist in rough weather conditions.

Code | 70174

## Cover Support

### Boat Cover Support System

SEA COVER Boat Cover Support System will ideally extend the life of your boat and cover. Easily installed and adjusted, it keeps water and debris from accumulating in the centre of the cover. The kit includes one telescopic aluminium pole (50cm to 116cm) that is positioned in the centre of your boat with a wide support on top and polypropylene webbing straps, which are hooked from bow to stern. The Boat Cover Support System fits all covers for boats up to 7m.



Code | 57276

### Installation Instructions:

1. Position the strap centre point over the bow of the boat. The protective sleeves should be positioned so that the strap does not come in contact with the front edges of the boat
2. Pull the straps evenly over the boat
3. Weave the straps through the triangular support piece in an "under-over-under" pattern, so that the straps lay on top of the support
4. Insert the pole into the triangular support piece and raise the pole to its highest point. Twist the pole sections to loosen and to tighten
5. Hook the ends of the straps on the boat trailer
6. Adjust the straps evenly so that they are tight and the pole stands upright
7. Carefully pull the boat cover over the straps, so as not to push over the pole. The pole may need to be adjusted in height depending on the shape and size of your boat and its cover



### Boat Cover Support, Telescopic, Aluminium

Ideal for wintering to prevent the accumulation of water on the cover in case of rain.



Code	Height (mm)
43213	From 665 to 1020
27497	From 865 to 1510
43214	From 1255 to 2020

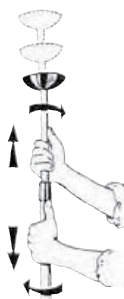

### Hook for Inflatable Boat Cover

Rope or shock cord Ø 8 mm max.  
Length 40 mm x Height 40 mm



Code	Colour
28112	Black
44015	White
44016	Grey



These mats and carpets are designed to provide you with the maximum comfort and safety when walking on your boat's deck by creating a comfortable, elastic and anti-slip walking surface. Manufactured according to the international standards, they are non-toxic and environment friendly products, especially designed for use in boats. However, they can be adequately used in office buildings, commercial buildings, restaurants and in other areas with heavy traffic. Marine carpets and mats are made of soft and durable PVC material for extra resistance to seawater, fuel and oil spillage. Thanks to their UV-stabilisers, they are suitable for areas exposed to the sunlight. The loop layer is made in order to trap dirt and filth, protecting at the same time the floor. The Welcome Mats are available with backing, whereas marine carpets are available in two types, one with backing, in roll and separate pieces and a second one without backing, in roll version only. Depending on the model, there are two sizes, while all models are in grey and blue colour.

## Welcome Mat, PVC, with Backing



Code	57196	57198
Colour	Blue	Blue
Dimensions (cm)	40x60	60x90

## Marine Carpet, PVC, with Backing



Code	57201	57202
Colour	Grey	Blue
Width (cm)	120	

\* Sold by linear meter

## Marine Carpet, PVC, without Backing



Code	57203	57204
Colour	Grey	Blue
Width (cm)	120	

\* Sold by linear meter

Deck Equipment

# Flags & Accessories



### Greek Flag

Code	10951	10952	10954	10957
Dimensions(cm)	20x30	30x45	50x75	100x150



### Croatian Flag

Code	10909	10910	10912	10915
Dimensions(cm)	20x30	30x45	50x75	100x150



### Italian Flag

Code	10958	10959	10961	10964
Dimensions(cm)	20x30	30x45	50x75	100x150



### French Flag

Code	10937	10938	10940	10943
Dimensions(cm)	20x30	30x45	50x75	100x150



### German Flag

Code	10944	10945	10947	10950
Dimensions(cm)	20x30	30x45	50x75	100x150



### Spanish Flag

Code	10993	10994	10996	10999
Dimensions(cm)	20x30	30x45	50x75	100x150



### European Flag

Code	10923	10924
Dimensions(cm)	20x30	30x45



### Cyprian Flag

Code	11015	11017
Dimensions(cm)	30x45	50x75



### Dutch Flag

Code	10965	10966
Dimensions(cm)	20x30	30x45



### Swiss Flag

Code	11066	11067
Dimensions(cm)	20x30	30x45



### Austrian Flag

Code	11054	11055
Dimensions(cm)	20x30	30x45



### Polish Flag

Code	11056	11057
Dimensions(cm)	20x30	30x45



### Slovenian Flag

Code	10986	10987
Dimensions(cm)	20x30	30x45



### Pirate's Flag

Code	11250
Dimensions(cm)	30x45



### Obligatory Flags for Cat. 3, 4, 5 (France)

Code	Dimensions cm
11517	30x40



### Diver Down Flag

Code	67169
Dimensions(cm)	35x50

## International Marine Code (40 pcs)

Includes:

- 26 Letters (20 x 30cm)
- 11 Pennants (43 x 15cm)
- 3 Substitutes (30 x 15cm)

Code | 11086



Deck Equipment

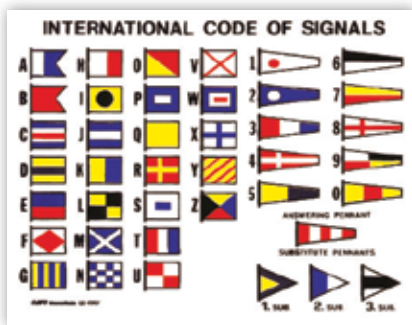

### International Code of Signals, Chart

Adhesive Dimensions: 16 x 12 cm

Code | 45256



### International Signaling Flags

Adhesive Dimensions: 32 x 47 cm

Code | 831621

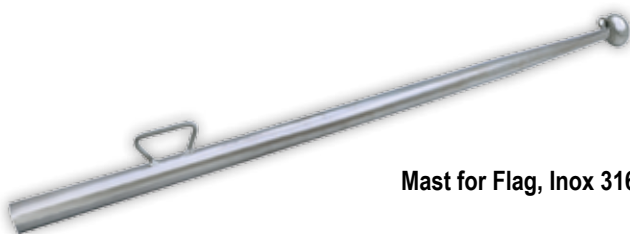

### Mast for Flag, Inox 316

Code	Diameter (mm)	Length (mm)
70637	25	750
70638	25	900
70639	25	1250

Combine with Bases page 212

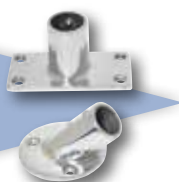

### Flagstaff

Code	Description	Length (cm)	Colour
43226	With 2 bases : 1 vertical, 1 horizontal	29	Black
43230	With 2 bases : 1 vertical, 1 horizontal	39	Black
43232	With rubber base	39.5	Black
43225	Screw-type, tilted	30	Black
43224			Grey
43237	Ø 92 mm rubber base. Compatible with models 43224, 43225, 43226, 43230. Suction cup fastening device	-	Black



### Mast Support to be Mounted on Stanchion, Inox 304

Code	95692
Base Diam.(mm)	22
Support Diam. (mm)	22 - 32
Weight (gr)	200



### Plug in Pole for Flag

Using the same proven symmetrical locking tube design as our pole lights, the flag base is made of ABS with a 50-100cm long pole Inox 316. It withstands strong winds for a long period of time. Easily removed to ease rapid storage.

Code	30360	30370	30700	30710
Length (cm)	50	100	50	100
Base colour	Black		White	



# Sailing Hardware



The sailing hardware incurs a lot of deterioration due to bad weather conditions and most of its equipment erodes. In order to avoid such occasions, you must always look for the best sailing hardware.

MARINA Stores can provide you with the best marine hardware equipment, with a product range that includes: shock cords, wire accessories, rigging accessories, blocks, winch handles, cam cleats & accessories, sail accessories, steering equipment, bosun's chairs, rigging & sail repair tapes, webbing & webbing adjusters.

<b>Sailing Ropes / Scotta</b> _____	<b>233-235</b>	<b>Stay Adjusters</b> _____	<b>244</b>
<b>Ropes For General Use</b> _____	<b>235</b>	<b>Clam Cleats &amp; Fairlead</b> _____	<b>244-245</b>
<b>Winch Handles &amp; Accessories</b> _____	<b>235-236</b>	<b>Sails Accessories</b> _____	<b>245</b>
<b>Wire Ropes &amp; Accessories</b> _____	<b>236</b>	<b>Wind Indicators &amp; Clinometers</b> _____	<b>245-246</b>
<b>Rigging Accessories</b> _____	<b>236</b>	<b>Steering Equipment</b> _____	<b>246</b>
<b>Pins</b> _____	<b>237</b>	<b>Bosun's Chairs</b> _____	<b>246</b>
<b>Turnbuckles</b> _____	<b>237</b>	<b>Rigging &amp; Sail Repair Tapes</b> _____	<b>247</b>
<b>Snap Hooks &amp; Carabiners</b> _____	<b>237-239</b>	<b>Webbing &amp; Buckles</b> _____	<b>247</b>
<b>Blocks &amp; Spare Parts</b> _____	<b>240-244</b>		

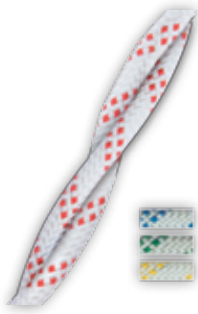

\* Sold by linear meter

### Halyard Cruising Rope

This rope is ideal for use as a halyard, having high performance. It features a pre-stretched, three-strand braid that offers an exceptional result to the high resistance and the low stretching.

Code	Diameter / Colour	Length (m)	Breaking Load (kg)
92005	3mm / white with blue braid	200	230
92006	3mm / white with red braid		
72229	3mm / white with green braid		
72230	3mm / white with yellow braid		
92009	4mm / white with blue braid		
72231	4mm / white with red braid	360	
72232	4mm / white with green braid		
72233	4mm / white with yellow braid		
92017	6mm / white with blue braid	840	840
92018	6mm / white with red braid		
72234	6mm / white with green braid		
72235	6mm / white with yellow braid		
92021	8mm / white with blue braid	1.460	1.460
92022	8mm / white with red braid		

Code	Diameter / Colour	Length (m)	Breaking Load (kg)
72236	8mm / white with green braid	200	1.460
72237	8mm / white with yellow braid		
92025	10mm / white with blue braid		
92026	10mm / white with red braid		
72238	10mm / white with green braid		
72239	10mm / white with yellow braid	3.170	
92029	12mm / white with blue braid		
92030	12mm / white with red braid		
72240	12mm / white with green braid	4.600	
72241	12mm / white with yellow braid		
72242	14mm / white with blue braid		
72243	14mm / white with red braid		
72244	14mm / white with green braid		
72245	14mm / white with yellow braid		

### Scotta Cruising Rope

This polyester rope with its double braid is extremely flexible and its special construction makes it particularly easy to tie, but also suitable for any boat. During its construction a special process removes any residual elongation, adding stability. Its easy and high-quality handling, a result of its special machining, is maintained for life.



Code	Diameter / Colour	Length (m)	Breaking Load (kg)
94789	6mm / blue	200	770
94790	6mm / red		
72217	6mm / green		
72218	6mm / yellow		
94791	8mm / blue		
94792	8mm / red	1.330	
72219	8mm / green		
72220	8mm / yellow		
94793	10mm / blue	2.150	
94794	10mm / red		
72221	10mm / green		
72222	10mm / yellow		

Code	Diameter / Colour	Length (m)	Breaking Load (kg)
98994	12mm / blue	200	2.860
71747	12mm / red		
72223	12mm / green		
72224	12mm / yellow		
94797	14mm / blue		
94798	14mm / red	4.190	
72225	14mm / green		
72226	14mm / yellow		
94799	16mm / blue	100	5.100
94800	16mm / red		
72227	16mm / green		
72228	16mm / yellow		

\* Sold by linear meter

### Superline Braided, Dyneema 100%

Ideal rope for small sailing boats like Optimist, Laser and other dinghies. Can be used as rope for spearguns, too.



Code	63452	63156	63453
Diameter (mm)	1	2	3
Colour	red/ black-white	yellow/ black-white	blue/ black-white
Width (m)	200		
Breaking Load (kg)	100	130	360

\* Sold by linear meter

### Wind-surf Rope

Made of Polypropylene for high durability and high UV resistance. Can be used for all purposes. Available in three colours, blue, red and yellow. Excellent rope to be used as a flag rope.



Code	Diameter / Colour	Length (m)	Breaking Load (kg)
92125	2mm / blue	200	40
92128	3mm / blue		90
98995	4mm / blue		110
98998	5mm / blue		130
99000	5mm / yellow		130
99001	6mm / blue		150
99002	6mm / red		150
99003	6mm / yellow		150

\* Sold by linear meter

### Olive for Shock Cord



Code	Diameter (mm)	Weight (gr)
90587	5	15
90588	6	15
90589	8	20

### Marine Shock Cord, Covered by Polyester for Nautical Uses



Code	Diameter (mm)	Length (m)	Breaking Load (kg)
90550	3/16" (5)	200	90
90551	1/4" (6)		
90552	5/16" (8)		
90553	3/8" (10)		

\* Sold by linear meter



Sail Furling Ties (4 pcs/set)

Code	Dimensions (mm)	
	Diam.	Length
98959	4	400
98960		500



Luggage Stretchcords

Code	Dimensions (mm)	
	Diam.	Length
98896	9.5	510 - 1,020

Ropes For General Use



Multi-Purpose Rope, Double Braid

Made of polyester, very soft and ideal for multiple uses on the boat. It can be used on fenders and sea anchors.

\* Sold by linear meter

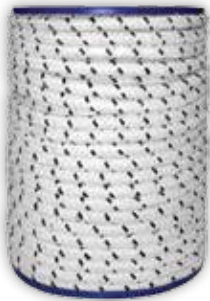

Code	Ø (mm)	n° Plaits	Length (m)	Breaking Load (kg)
92036	4	16	200	370
92037	5			460
92038	6			660
92039	8			1.050
92040	10	24	200	1.416
92041	12			2.090
92042	14			2.613
92043	16			2.755
			100	2.755

Code	Ø (mm)	Length (m)	n° Plaits	Breaking Load (kg)
72420	6	20	16	660
72421		30		
72422		40		
72423		50		
72424	8	20	24	1.050
72425		30		
72426		40		
72427		50		
72428	10	20	24	1.416
72429		30		
72430		40		
72431		50		
72432	12	20	24	2.090
72433		30		
72434		40		
72435		50		



Sailing Hardware

Winch Handles & Accessories



Winch Handles, Floating

- Floating if dropped overboard
- Designed to operate efficiently with the minimum effort required
- Durable, lightweight & easy to handle
- With locking mechanism
- Glass reinforced PA

Code	Description	Length (cm)
72740	with lock	20
72741		25
72742	without lock & without handle	20
72743		25
72907	without lock	25

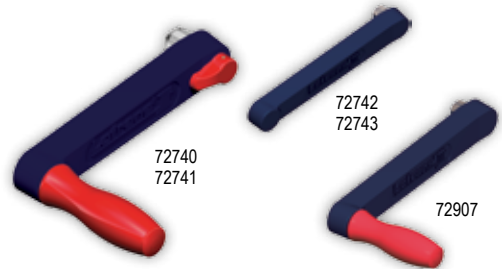

Winch Handles, Anodised Aluminium

- Designed to operate efficiently with the minimum effort required
- Durable, lightweight & easy to handle
- Available options with speed handle
- With upgraded locking feature to ensure lock & unlock position. This increases the mechanism's lifetime, by protecting it from unintentional damage during use.
- Black Anodised Aluminium

Code	Description	Length (cm)
11856	with lock	20
11857	with lock & speed handle	
11860	with lock	25
11861	with lock & speed handle	



Winch Handles, Glass Reinforced PA

- Designed to operate efficiently with the minimum effort required
- Durable, lightweight & easy to handle
- With upgraded locking feature to ensure lock & unlock position. This increases the mechanism's lifetime, by protecting it from unintentional damage during use.
- Glass Reinforced PA

Code	Description	Length (cm)
74611	with lock	20
74612		25

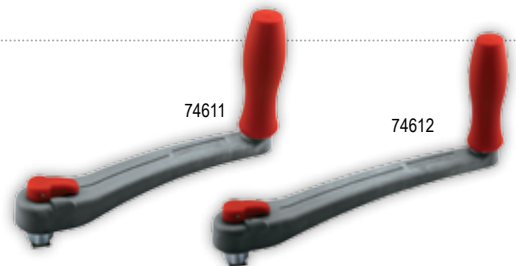

## Winch Handles & Accessories



Winch Handle Pocket

Code	99587
Length (mm)	241
Width (mm)	89
Height (mm)	50



Winch Handle Pocket, PVC

Code	Dimensions (mm)	Colour
198208	L.240, W.92, H.55	Grey
198209		White



Winch Handle Holder, Side Mounted, Glass Reinforced Nylon, Grey

L.60mm, W.19mm, H.45mm

Code 198210

## Wire Ropes & Accessories

Sailing Hardware

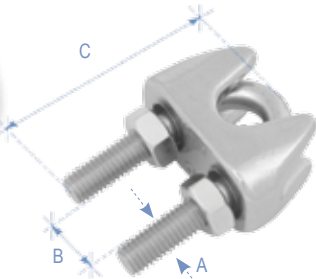

Wire Rope Clip

### Galvanized

Code	99401	99403	99405
Size (mm)	3	5	8
A (mm)	3	5	6
B (mm)	5	7	10
C (mm)	21	25	35

### Inox 316

Code	91845	91847	91935
Size (mm)	3	5	8
A (mm)	3	5	6
B (mm)	5	7	10
C (mm)	21	25	35

\*Surface E.P.  
Body: Casting  
U – bolt: Forging



Copper Sleeves

Code	92660	92661	92662	92663	92664	92665
Diam. (mm)	2	2,5	3	4	5	6

Wire Rope, 7x19, Inox 316

Code	98095	98071
Diam. (mm)	3	5
Breaking load (N)	6300	16600

\* Sold by linear meter



Wire Rope, 7x19, Inox 316, with PVC Coating

Code	98074	98075
Diam. (mm)	3-6	4-8
Breaking load (N)	6000	8000

\* Sold by linear meter

## Rigging Accessories

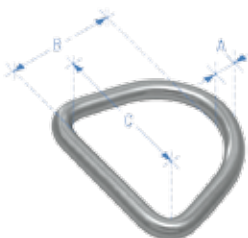

D-Ring, Inox 304

Code	97034	91931	91932	96977	91933	96978	91934	96979
Size (mm)	3x25	4x25	4x30	4x50	5x40	6x30	6x50	6x70
A (mm)	3	4		5		6		
B (mm)	20	25	30	30	40	30	50	50
C (mm)	17	22	27	27	37	27	47	47



Delta Ring, No 80, Inox 304

Code 00003

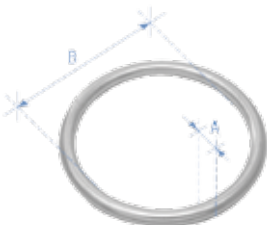

Round Ring, Inox 316

Code	96934	96936	91840	96961	96962	91841	91968	96990	96992
Size (mm)	3x25	4x25	5x30	6x40	7x45	8x40	8x50	8x80	9x90
A (mm)	3	4	5	6	7	8		9	
B (mm)	25	25	30	40	45	40	50	80	90



D-Ring, 50mm, Inox 304

Code 00153

Pin, Inox 304

Code	91978	91979	91980	91981	91982	91983	91984	91985	91986	91987	91988	91989	91990	91991
Size (mm)	5x18	5x21	6x20	6x25	6x29	6x36	6x45	8x20	8x25	8x27	8x32	10x30	12x30	12x45
L (mm)	20,5	24	23	28	32	39	48	24	29	31	36	34,5	35,5	50,5
L1 (mm)	18	21	20	25	29	36	45	20	25	27	32	30	30	45
L2 (mm)	14	17	16	21	25	32	41	16	21	23	28	26	26	40
D (mm)	5	5	6	6	6	6	6	6	8	8	8	10	12	12
Ø (mm)	2	2	2,5	2,5	2,5	2,5	2,5	3	3	3	3	3,5	3,5	3,5
A (mm)	8	8	9	9	9	9	9	11	11	11	11	14	16	16

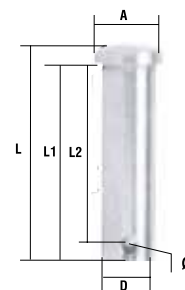

Turnbuckles

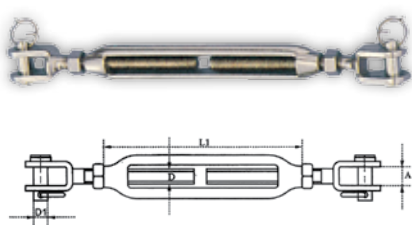

Frame Turnbuckle with Nut, Jaw & Jaw, Inox 316

Code	91951	91952	91953	91954
Size (mm)	5	6	8	10
A (mm)	6,5	7,5	11	12
D1 (mm)	5	6	8	9
L1 (mm)	120	140	180	220

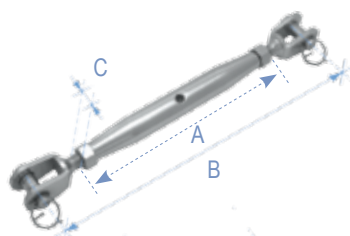

Pipe Turnbuckle with Nut, Jaw & Jaw, Inox 316

Code	91259	91260	91261	91262
Size (mm)	5	6	8	10
A (mm)	80	95	105	125
B (mm)	130	150	165	190
C (thread)	M5	M6	M8	M10

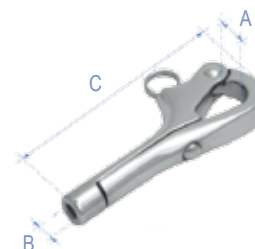

Pelican Hook, Inox 316

Code	90441	91181
Size (mm)	6	8
A (mm)	13	16
B (mm)	M6	M8
C (mm)	76	100



Snap Hooks & Carabiners



Snap Hook, Polyamide  
Suitable for lightweight use only

Code	Model	Colour	For Shock Cord Ø (mm)	Length (mm)	Ø Eye (mm)
44028	With eye	White	4	42	10
44029	With eye	Black		42	10
44034	With eye	White	6	49	10
44035	With eye	Black		49	10
44040	With eye	White	8	58	12
44041	With eye	Black		58	12
44046	With eye	White	10	68	14
44047	With eye	Black		68	14



Snap Hook, Polyamide  
Suitable for lightweight use only

Code	Model	Colour	For Shock Cord Ø (mm)	Length (mm)	Ø Eye (mm)
16795	With eye	Black	8	55	15
44022	With eye	White	6	40	9
44023	With eye	Black		40	9
43994	With eye	White		38	9
43995	With eye	Black	5	38	9
43977	Standard	Black		48	-



**Hook, Multi-Purpose, Small**

Code	Colour	For Rope Ø	Length (mm)	Width Between Holes (mm)
43988	White	Rope 4 mm max.	40	30
43989	Black	Shock cord 6/8 mm max.		



**Hook, Spinnaker, Small**

Code	Colour	For Rope Ø	Length (mm)	Width Between Holes (mm)
16679	Black	Sheet 6 mm max	55	42



**Hook, Multi-Purpose, Small**

Code	Colour	For Rope Ø	Length (mm)	Width Between Holes (mm)
43982	White	Rope 6 mm max. Shock cord 8/10 mm max.	30	20
43983	Black			



**Shackle, Plastic**

Sail slide hank, suitable to attach to sail sliders

Code	Colour	Diameter Ø (mm)	Safe Working Load (kg)
16764	White	6	80



**Hook, Multi-Purpose, Small**

Code	Colour	For Rope Ø	Length (mm)	Width Between Holes (mm)
16680	Black	Rope or shock cord 4 mm max.	30	20

Sailing Hardware

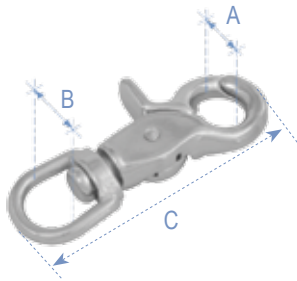

**Trigger Snap with Swivel End, Inox 316**

Code	91885	96969
Size (mm)	13	16
A (mm)	12	12
B (mm)	13	16,8
C (mm)	66,5	69,5
T.D.L.*	200	200
R.W.L.*	50	50

Surface\*: E.P., Body: Casting

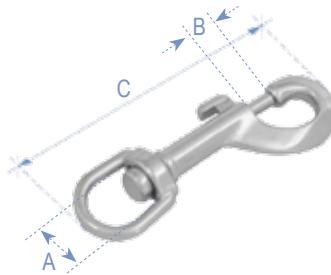

**Bolt Snap with Swivel End, Inox 316**

Code	91891	91892	96972	96973
Size (mm)	13	16	19	32
A (mm)	13,5	17	20,5	33
B (mm)	7	8	8	13,7
C (mm)	75	85	91	120
T.D.L.*	250	650	650	550
R.W.L.*	63	163	163	138

Surface\*: E.P., Body: Casting

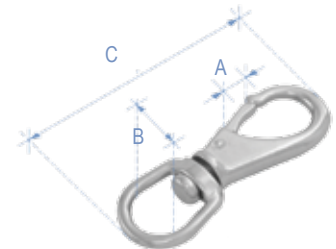

**Swivel Eye Snap, Inox 316**

Code	91896	91897	91898	91899
Type	No.0	No. 1	No. 2	No. 3
A (mm)	10	13	15,5	20,5
B (mm)	16,5	19,5	20,5	19,5
C (mm)	69	85	99	117,5

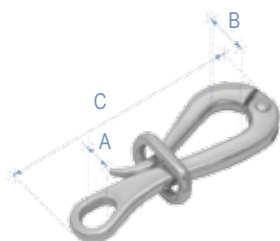

**Pelican Hook with Link, Inox 316**

Surface\*: M.F. Body: Casting

Code	97004	97005
Size (mm)	100	150
A (mm)	10	13
B (mm)	18	22
C (mm)	100	150
T.D.L.*	760	1,200
R.W.L.*	190	300

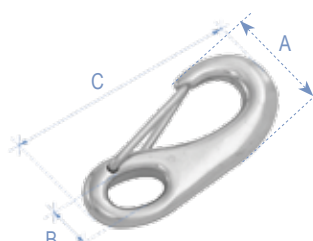

**Spring Snap Casting, Inox 316**

Surface \*: E.P., Body: Casting

Code	91906	91907	91908
Size (mm)	50	70	100
A (mm)	24	30	46
B (mm)	7	10	14,5
C (mm)	48	68,5	94
Working Load	63,5	181,43	362,87

\*Recommended working load "R.W.L." is ¼ of "T.D.L." tested deformation load - Surface E.P.= Electro polished





## Snap Hook, Inox 304

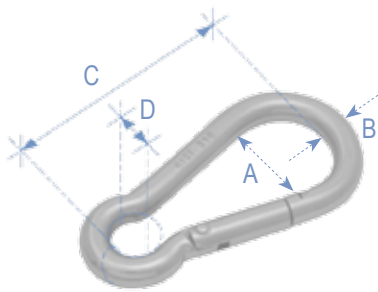

Code	91374	91375	91376	91377	91378
Size (mm)	5	6	7	8	10
A (mm)	16	18	20	24	31
D (mm)	8	9	11	12	15
B (mm)	5	6	7	8	10
C (mm)	40	48	56	64	80

## Snap Hook, Inox 316

Surface\*: E.P.

Code	91757	91758	91759	91760	91761	91762	91739	91764	91765
Size (mm)	5	6	7	8	9	10	11	12	13
A (mm)	16	18	20	24	27	31	37	40	46
D (mm)	8	9	11	12	13	15	18	22	22
B (mm)	5	6	7	8	9	10	11	12	13
C (mm)	40	48	56	64	72	80	98	116	134
Working load*	36,288	63,288	90,72	113,4	127,008	181,44	226,8	272,16	317,52

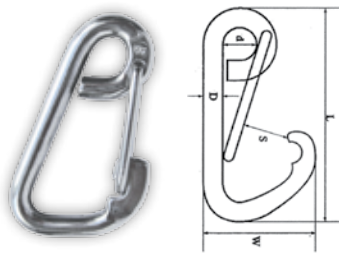

Spring Snap with Angled Latch, Inox 316

Code	91385	91386	91387	96944
Size (mm)	6	8	10	12
D (mm)	6	8	10	12
L (mm)	60	80	100	120
W (mm)	35	46	58	70
S (mm)	11	18	22	26
d (mm)	9	11	15	18

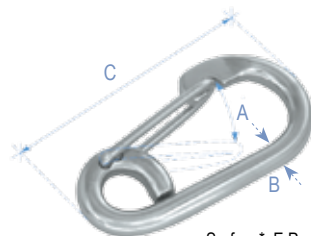

Surface\*: E.P.  
Body: Forging

Spring Snap with Eye End, Inox 316

Code	90451	91766	91767	91768
Size (mm)	6	8	10	12
A (mm)	13	18	21	27
B (mm)	5,7	7,7	9,7	11,7
C (mm)	60	80	100	120
Working Load	45,36	181,44	272,16	453,6

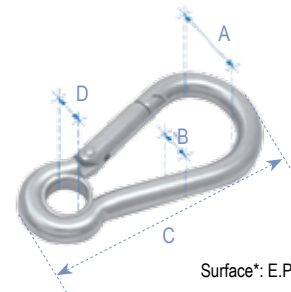

Surface\*: E.P.

Snap Hook with Eye End, Inox 316

Code	91915	91916	91917	91918	91919
Size (mm)	5	6	8	10	12
A (mm)	15	18	24	30	43
D (mm)	5	5	10	13	15
B (mm)	4,7	5,7	7,7	9,7	11,7
C (mm)	50	60	80	100	140
Working Load	99,79	117,94	227	349,27	544,32

\*Recommended working load "R.W.L." is 1/4 of "T.D.L." tested deformation load - Surface E.P.= Electro polished



Asymmetric Cabine Hook, Inox 316

Code	98524
Diameter (mm)	8



Aluminium Carabiner

Code	98987
Dimensions (mm)	4x40



Aluminium Carabiner

Code	98988
Dimensions (mm)	6x60



Aluminium Carabiner

Code	98989	98990
Dimensions (mm)	8x80	10x100

## S-Hook, Inox 316

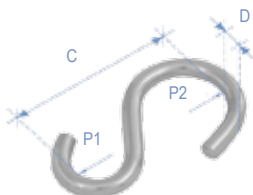

Code	95686	95687	95688	95689	97039	97040
Size (mm)	30	36	43	50	67	85
P1 (mm)	4,5	6	7	7,5	10	12,5
P2 (mm)	8	9,5	10,5	12,5	16,5	20,5
D (mm)	3	4	5	6	8	10
C (mm)	30	36	43	50	67	85
T.D.L.*	25	50	120	140	250	435
R.W.L.*	6,25	12,5	30	35	62,5	108,75

## Oblong Pad, Hook Type, Inox 304

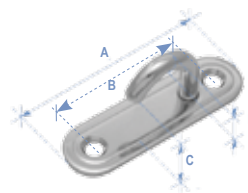

Code	95678	95679
Size (mm)	5	6
A (mm)	54	65
B (mm)	38	46
C (mm)	8	12
D (mm)	5	6
T.D.L.*	200	220
R.W.L.*	50	55

Rope Diam.: 5 mm - Ball Bearing Diam.: 17mm - Breaking Load: 300kg

Blocks for Optimist 4 & Small Dinghy



Single Micro Block

Code | 92462



Swivel Ball Bearing Block with Shackle

Code | 92464



Double Micro Block

Code | 92465



Double Micro Block with Becket

Code | 92466



Single Micro Block with Ferrule

Code | 92470

Rope Diam.: 6mm - Ball Bearing Diam.: 22mm - Breaking Load: 700kg - Working Load: 100kg

Racing: Blocks for Lightning & Laser

Single Ball Bearing Block without Balls



Code | 92481

Single Ball Bearing Block



Code | 95822

Single Swivel Ball Bearing Block without Balls, with Shackle



Code | 92484

Single Swivel Ball Bearing Block with Shackle

Code | 95824



Single Swivel Ball Bearing Block without Balls

Code | 92483

Double Ball Bearing Block

Code | 92486



Double Ball Bearing Block with Becket

Code | 92487



Triple Ball Bearing Block

Code | 92489



Swivel Ball Bearing Block on Curved Base

Code | 92488

Rope Diam.: 6mm - Ball Bearing Diam.: 25mm - Breaking Load: 650kg

Blocks for Dinghy up to 6m



Single Block

Code | 95811



Swivel Block with Shackle

Code | 95813



Double Block

Code | 95814



Triple Block

Code | 95815

Rope Diam.: 8mm - Ball Bearing Diam.: 25mm  
Breaking Load: 650kg

Blocks for Dinghy up to 6m

Single Block with Balls

Code | 92473



Single Ball Bearing Block

Code | 95820



Single Swivel Ball Bearing Block with Balls and Shackle

Code | 92475



Single Block on Base (1"X2 1/2")

Code | 92476



Single Block on Curved Base (1"X2 1/2")

Code | 92477



Fiddle Block with Vee Jam

Code | 92479

Rope Diam.: 8mm - Ball Bearing Diam.: 28mm - Breaking Load: 750kg - Working Load: 150kg

Racing: Blocks for Sailing Yachts up to 32ft



Single Ball Bearing Block Thru Beck

Code | 95834

Control Lines

Rope Diam.: 8mm - Ball Bearing Diam.: 28mm - Breaking Load: 750kg - Working Load: 150kg

Racing: Blocks for Control Lines, for Sailing Yachts up to 32ft



Single Ball Bearing Block

Code | 92496



Single Ball Bearing Block with Becket

Code | 92497



Single Swivel Ball Bearing Block

Code | 92498



Single, Swivel Ball Bearing Block with Shackle

Code | 92499



Single Swivel Ball Bearing Block with Shackle and Becket

Code | 92500



Double Ball Bearing Block

Code | 92501



Single Swivel Ball Bearing Block on Curved Base

Code | 92504



Triple Ball Bearing Block

Code | 96106

Rope Diam.: 8mm - Ball Bearing Diam.: 34mm - Breaking Load: 800kg - Working Load: 300kg

Cruising: Blocks for Main Sheet & Halyard, for Sailing Yachts from 26 to 32ft



Single Ball Bearing Block

Code | 92512



Single Ball Bearing Block with Becket

Code | 92513



Double Ball Bearing Block

Code | 92514



Fiddle Ball Bearing Block

Code | 92516



Fiddle Ball Bearing Block with Becket

Code | 92517



Fiddle Ball Bearing Block with Becket and Vee Jam

Code | 92519



Single Cheek Bearing Block

Code | 92520



Single Ball Bearing Block

Code | 96112



Sailing Hardware

Rope Diam.: 10mm



Block, Inox,  
10mm

Code | 10134



Single Swivel  
Head, 10mm

Code | 10131



Single  
Swivel Head &  
Becket, 10mm

Code | 10132



Fiddle Swivel  
Head, 10mm

Code | 10133

Rope Diam.: 10mm - Ball Bearing Diam.: 38mm - Breaking Load: 950kg  
- Working Load: 230kg

Racing: Blocks for Main Sheet & Halyard, for Sailing Yachts up to 30ft



Single Ball  
Bearing  
Block

Code | 92455



Swivel Ball  
Bearing  
Block with  
Shackle

Code | 92457



Single Ball  
Bearing  
Cheek Block

Code | 92461



Double Ball  
Bearing Block

Code | 92459



Double Ball  
Bearing Block  
with Becket

Code | 92460



Triple Ball  
Bearing Block  
with Becket

Code | 96108



Triple Ball  
Bearing  
Block

Code | 95831



Triple Ball Bearing Block with  
Carbon Fibre Ball

Code | 95830



Triple Ball Bearing Block with  
Becket-Carbon Fibre Ball

Code | 95832

Rope Diam.: 10mm - Ball Bearing Diam.: 45mm - Breaking Load: 950kg  
- Working Load: 370kg

Racing: Blocks for Main Sheet & Halyard, for Sailing Yachts up to 36ft



Single Ball  
Bearing Block,  
Universal  
3-Way Head

Code | 92537



Single Ball  
Bearing Block  
With Becket,  
Universal 3-Way  
Head

Code | 92538



Double Ball  
Bearing Block

Code | 92539



Single Ball  
Bearing Block

Code | 96118



Single Ball Bearing Block  
with Swivel

Code | 96120



Fiddle Ball Bearing Block with Ball Bearing  
Cam Cleat, Universal 3-Way Head

Code | 92543



Fiddle Ball Bearing Block, Becket  
with Ball Bearing Cam Cleat,  
Universal 3-Way Head

Code | 92544



Single Ball Bearing Block and  
Becket with Ball Bearing Cam Cleat  
& Universal 3-Way Head

Code | 92545

Rope Diam.: 10mm - Ball Bearing Diam.: 45mm  
 Breaking Load: 950kg - Working Load: 370kg

Racing: Blocks for Main Sheet & Halyard, for Sailing Yachts up to 36ft



Double Ball Bearing Block with Becket

Code | 96123



Fiddle Ball Bearing Block & Universal 3-Way Head

Code | 96121



Fiddle Ball Bearing Block with Becket Universal 3-Way Head

Code | 96122

Rope Diam.: 10mm - Ball Bearing Diam.: 57mm - Breaking Load: 900kg - Working Load: 220kg

Racing: Blocks for Racer Sailing Yachts Main Sheet 26 to 36ft



Single Ball Bearing Ratchet Block

Code | 92510



Single Bearing Ratchet Block-Becket with Ball Bearing Cam Cleat

Code | 92511

Rope Diam.: 12mm - Ball Bearing Diam.: 57mm - Breaking Load: 1000kg - Working Load: 280kg

Racing: Blocks for Main Sheet & Halyard, for Sailing Yachts up to 36ft



Single Ball Bearing Block

Code | 92491



Double Ball Bearing Block

Code | 92493



Double Ball Bearing Block with Becket

Code | 92494

Rope Diam.: 12mm - Ball Bearing Diam.: 57mm - Breaking Load: 1450kg - Working Load: 580kg

Cruising: Blocks for Main Sheet & Halyard, for Sailing Yachts up to 36ft



Single Ball Bearing Block

Code | 92547



Single Ball Bearing Block with Becket

Code | 92548



Fiddle Ball Bearing Block

Code | 92549



Fiddle Ball Bearing Block with Ball Bearing Cam Cleat

Code | 92551

Rope Diam.: 12mm - Ball Bearing Diam.: 57mm - Breaking Load: 1450kg - Working Load: 580kg

Cruising: Blocks for Main Sheet & Halyard, for Sailing Yachts up to 36ft



Fiddle Ball Bearing Block with Becket and Ball Bearing Cam Cleat

Code | 92552



Double Ball Bearing Block

Code | 92554



Single Ball Bearing Block with Becket and Ball Bearing Cam Cleat

Code | 92553



Double Ball Bearing Block with Becket

Code | 92555



Sailing Hardware

## Blocks & Spare Parts

Rope Diam.: 14mm - Ball Bearing Diam.: 76mm - Breaking Load: 2300kg - Working Load: 800kg

Racing: Blocks for Main Sheet, Spinnaker & Halyard, for Sailing Yachts up to 40ft



Single Ball Bearing Block

Code | 92505



Single Swivel Ball Bearing Block with Becket

Code | 92506



Double Ball Bearing Block

Code | 92507



Double Ball Bearing Block with Becket

Code | 96109

Halyard Blocks for Albury Exit & Outhaul Blocks for boom Sail Exit, for Sailing Yachts up to 38ft



Single Sheave Box

Washer Diam.: 34mm  
Wire Diam.: 5mm  
Breaking Load: 700kg

Code | 92529



Sheaves, Nylon

Code	D1 (mm)	D2 (mm)	D3 (mm)	S (mm)
92611	22	8,2	8	13,2
92613	25		8	10
92614	27		10	15
92615	33,5		10	13
92617	45		10	13,4
92619	54		12	17,5



Sheaves with S/S Balls & Covers, Nylon

Code	D1 (mm)	D2 (mm)	D3 (mm)	S (mm)
92620	28	5,3	10	14,6
92622	34	5,3	8	10,9
92621	34	5,3	12	18,3
92623	45	8,8	10	14,6
92624	57	8,8	12	18,3



## Stay Adjusters



Stay Adjuster

Code	92671	92676	92677	92672
Length (cm)	12	14,5	20,5	100



Stay Adjuster

Code	92673
Length (cm)	12

## Clam Cleats & Fairlead



16684



16681



16685 - 16686



44427

Fairleads

Code	16684	16685	16686	16681	44427	44426
Colour	Black	Black		Black	Black	White
Ø Max. rope (mm)	18	13	17	7	10	
Overall dimensions Width x Height (mm)	65x28	41x26	55x30	35x15	40x17	
Hole spacing (mm)	45	30	40	19	28	



## Clam Cleats & Fairlead



Code	Description
92580	Clamcleat (naylon), Diam. 6-12mm, Diam. hole 6 mm
92581	Clamcleat (aluminium), Diam. 3-6mm, Diam. hole 4 mm
92582	Clamcleat (aluminium), Diam. 6-12mm, Diam. hole 6 mm
92583	Clamcleat (aluminium), Diam. 3-6mm, Diam. hole 5 mm
92584	Clamcleat (aluminium), Diam. 3-6mm, Diam. hole 5 mm
92585	Clamcleat (aluminium), Diam. 3-6mm, Diam. hole 4 mm
92586	Clamcleat (aluminium), Diam. 4-8mm



**Cam Cleat,  
3-8mm**

Code | 10141



**Cam Cleat,  
8-12mm**

Code | 10142

### Top Fairlead for Cam Cleat



Code	92564	92565	92566	92567	92573	92574
For Cam Cleat	10141			10142		
Colour	Black	Red	Yellow	Blue	Black	Red

### Fairlead and Bullseye



Code	92604	92610	92609
Diameter (mm)	12	6	10
Hole Diameter (mm)	5	4	5

### Rope Stopper



Code	92724	92726	92728	92730	92732	92734
Diameter (mm)	5		6		8	
Colour	Black	Yellow	Black	Yellow	Black	Yellow

## Sails Accessories



### Universal Cross-Tree Cover

Code	Colour	Length (mm)	Width (mm)	Height (mm)
197755	White	200	110	100



### Hook, Inox 304

Code	Dimensions (mm)
70623	6x50
70624	8x50
70625	10x65

## Wind Indicators & Clinometers



### WINDEX Wind Indicator

Code	99234	99235	99236	99237
Description	WINDEX 10	WINDEX 15	WINDEXL	WINDEX DINGHY
For Boats	up to 9 meters	9-14 meters	over 14 meters	Dinghy
Length Indicator (cm)	25	38	57	25
Weight (gr)	40	95	270	40
Height (cm)	24	34,5	49	27,5

## Wind Indicators & Clinometers



**Clinometer,  
10 degrees,  
8,9 x 3,9 cm,  
Plastic**

Code | 99981



**Clinometer,  
45 degrees,  
8,9 x 3,9 cm,  
Plastic**

Code | 99982



**Clinometer,  
2 scales,  
10 x 8,3cm,  
Plastic**

Code | 99983

## Steering Equipment



**Urethane UNIVERSAL Joint Suits**

Code | 95854



**Round Tiller Adaptor,  
Diam. 25-32 mm**

Code | 95855

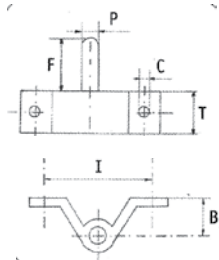

### Rudder Head

Code	Dimensions (mm)					
	I	P	C	T	B	F
92641	50	8	5	20	18	31
92642	50	8	5	20	18	40
92643	60	10	6	25	21	35
92644	60	10	6	25	21	44
92645	50	8	5	30	18	31
92646	50	8	5	30	18	40
92647	60	10	6	40	21	35
92648	60	10	6	40	21	44

\*Hardcote & PTFE, Anodised Aluminium

Sailing Hardware

### Rudder Retaining Clip



Code	Dimensions (mm)		Code	Dimensions (mm)	
	Length	Ø		Length	Ø
92633	75	8	92635	130	10
92634	103		92636	132	
92637	108		92639	177	
92638	136		92640	179	

## Bosun's Chairs



### Professional Bosun's Chair

LALIZAS Professional Bosun's Chair has been designed according to the highest quality standards, so that it can be used easily by professionals.

- Reinforced Nylon with PVC backing and PP webbing
- Supreme comfort for extended time aloft
- Comfortable wrap-around back
- Adjustable strap between the legs for extra safety
- Stows in its own bag, which becomes a tool pouch when the chair is in use
- Attached side tool case
- Pocket to fit an optional wooden seat (code: 00169)
- Retroreflective tapes for better visibility
- Floats in the water when it is empty



Code | 10210



### Safety Bosun's Chair

LALIZAS offers you a bosun's chair to allow you to work comfortably, safely, and in balance. It is made of tough Nylon 210D with PVC backing, thickness 0.35mm and comes complete with safety straps for added security, fitted side pockets for tools and a padded wooden seat.

Code | 10080



### Wooden Seat for Professional Bosun's Chair (10210)

Code | 01169





## Vinyl Foam Thermal & Sound Insulating Tape, Black

The thermal & sound insulating tape is suitable for the pipeline freezing resistance, insulation and decoration. Generally, it is used whenever a specific area or place needs to be insulated, in order to be protected by the variations of temperature or even to protect the people onboard by undesirable sounds. It can also be used between the hull and the sole boards, so as to minimize the squeaking noises. It is available in different sizes.



Code	Dimensions
11854	50mm x 5m
11855	25mm x 5m

## Masking Tape, White

It is a general-purpose tape and is suitable for holding or sealing, as well as for protecting surfaces. It has been designed for indoor use but also for extended outdoor use, since it can withstand up to 80°C temperature. It is supplied in white colour and different sizes.



Code	Dimensions
11851	20mm x 50m
11852	25mm x 20m
11853	50mm x 50m

## Nonslip Tape, with elasticity



Code	Dimensions	Colour
11848	25mm x 5m	Black
11849		Grey

## Marine Neoprene Tape "Hatchseal"

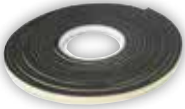

Code	Dimensions
11551	3m x 19mm x 3mm
11552	3m x 19mm x 6mm



## Mounting Tape, White

Nailing on the boat is over! With the double-sided adhesive tape. It is suitable for mounting pictures or any other decoration on most types of dry and smooth surfaces, you don't need nails when decorating your boat.

Code	Dimensions
11850	2mm x 18mm x 1.6m

### Instructions of Use

Use 10cm (4") of tape for every 227gr of the item to be mounted. The tape is suitable for objects with maximum weight up to 900gr.

1. Cut the tape at the necessary length. Do not remove the protective liner.
2. Press the tape on the back of the object to be mounted. Press firmly on the liner for a better outcome.
3. Remove the liner and press firmly the object on the wall



**Note:** If you wish to remove the mounted object, insert a knife behind the mounted object and cut the tape between the two surfaces. Don't pull the object, in order to avoid damaging the surface or the object.

## Marine Duct Tape

The Duct tape is a waterproof cloth tape, which can be used in numerous indoor or outdoor jobs and repairs. It is supplied in several colours and two different sizes.



Code	Dimensions	Colour
11545	50mm x 5m	Black
11546	50mm x 5m	White
11547	50mm x 5m	Red
11548	50mm x 5m	Blue
11549	50mm x 5m	Silver
11550	50mm x 50m	Black

# Webbing & Buckles



**Buckle, Female 50mm**

Code | 00152



**Buckle, Male 50mm**

Code | 00151



**Strap Regulator**

Code | 00071  
Colour | Blue

## Buckles



Code	Colour	Material	For webbing (mm)	Width (mm)	Length (mm)
43871	White	Plastic	30	55	35
43872	Black	Plastic			
43865	White	Plastic	25	55	35
43866	Black	Plastic			
43858	Black	Plastic	50	62	84
43857	-	INOX	50	54	74



**Delta Ring, No 80**

Code | 00003



**D-Ring, 50mm**

Code | 00153



## Webbing

Code	Description
00043	Polyester Webbing 25mm, White, (Roll 50m)
02035	Polyester Webbing 25mm - Yellow - (Roll 50m)
02262	Polyester Webbing 50mm, White, (Roll 50m)



# Electronics & Navigation



Chartplotters/Fishfinder _____	249-251	Antenna Mounts & Accessories _____	258-259
GPS _____	251-252	Radio/MP3/CD & Cases _____	260
VHF _____	252	Marine Speakers & Megaphone _____	260-261
Compasses _____	252-255	Binoculars _____	261-262
Hand Bearing Compasses _____	255	Navigation Instruments _____	262-263
TV & Radio Antennas _____	256	Cruising Charts & Pilot _____	263-267
VHF & Shortwave Antennas _____	257	Publications _____	267-269
Communications Accessories _____	257-258	Log Books _____	269
Connectors & Coaxial Cables _____	258		

At MARINA Stores you will find the most efficient and reliable boat electronic equipment in order to have optimum communication and navigation guidance on board. Get the proper marine electronics that fit your needs, such as VHF radios, marine GPS plotters, fish finders, marine VHF antennas and many other useful equipment. We also provide you with navigation equipment of the highest quality, so you can find your destination and orientation with accuracy.

**LOWRANCE**

Available only in certain countries

**ELITE FS**



**ELITE FS NO XD ROW**

- GPS-Plotter-Fishfinder
- CHIRP technology
- Integrated wireless NMEA 2000® and Ethernet connectivity
- Supports NMEA0183/RS422 @ protocol
- High-resolution multi-touch touchscreen
- Compatible with Radar external unit (Halo20/Halo20+/Halo24)
- Autopilot / Electronic Anchor Connection
- Built-in precision GPS antenna
- Mapping options including C-MAP, Navionics® and more. C-MAP® Easy Routing, Navionics® Autorouting capability
- C-MAP Genesis Live onscreen mapping
- StructureScan HD || DownScan Imaging™ & Side Scan Imaging™
- FishReveal™ Smart Target View
- Photo-realistic sea floor imagery
- Built-in micro SD port
- Wi-Fi / Bluetooth

Code	60001	60002	67173	67174
Touchscreen display (In.)	7"	9"	7"	9"
Active Imaging 3 in 1	-	-	✓	✓



Active Imaging 3 in 1



Electronics & Navigation



**HDS LIVE**

- GPS-Plotter-Fishfinder
- Solar MAX™ HD colour wide touch screen
- New generation Dual-Core/Quad Core processors
- Dual-Channel CHIRP Sonar (Sonar with 2 parallel sensors)
- StructureScan 3D - StructureScan HD - Structure Map™
- Lowrance - LiveSight™ Sonar
- FishReveal™ Smart Target View
- Built-in 10Hz high-precision GPS antenna
- C Map Genesis™ LIVE onscreen mapping
- Position correction support with WAAS / EGNOS / MSAS
- Ability to connect to Radar (3G/4G/Halo24)
- Autopilot/Electronic anchor connection
- SonicHub 2- audio server with screen control
- Ability to control via Tablet/Smartphone
- Dual Socket for Micro SD cards
- Communication port: NMEA 0183/ NMEA 2000 /Ethernet / USB/HDMI
- Wi-Fi/Bluetooth
- Support CMAP/Navionics map

Code	67170	67171	67176	67175
Touchscreen display (In.)	7"	9"	12"	16"

Available only in certain countries



**Hook Reveal**

- GPS-Plotter-Fishfinder
- CHIRP technology
- SolarMAX™ LED screen
- Auto mode settings
- TripleShot™ - StructureScan
- FishReveal™ Smart Target View
- C Map Genesis™ Live onscreen mapping
- Built-in high precision GPS antenna
- Built-in micro SD port

Code	67172	74350	74351
Screen display (In.)	9"	5"	7"

Contact MARINA Stores for any additional accessories & equipment!



Electronics & Navigation

**Transducer HST-DFSBL**



Classic 600W broadband sensor with 50/200 kHz frequencies for all kinds of fishing, up to 450 m depth. It can be mounted externally on the stern of the boat on the mirror. It is an ideal sensor for those fishing in the shallows and in deep waters.

- Coverage angles : 12 ° @ 200 KHz || 36 ° @ 50 KHz
- Contains temperature sensor
- Xducer ID® Technology
- Suitable for any hull
- (1) Internal broadband ceramic
- Includes a 7m Cable

Code | 65789

**Active Imaging 3-IN-1 Transducer**



Perfect for pinpointing fish-holding areas like rock piles. Delivers superior clarity and the highest resolution images of fish and structure at a longer range than any other structure imaging technology.

- High detail and long imaging range
- CHIRP, SideScan and DownScan technology
- Easier target identification with FishReveal™ Smart Target View
- Supports Medium and High CHIRP (83/200kHz) + 455/800kHz frequencies
- Compatible with Lowrance HDS LIVE & ELITE FS

Code | 74709



Available only in certain countries

**Digital Chart, SD Card,  
Mediterranean & Black Sea MSD/NAV+43XG**



Code | 65787

**Digital Chart, SD Card,  
Greece Area, GOLD D-L SMALL**



Code | 65786



Available only in certain countries

**Fishfinder Striker 4 with 3,5" colour Display , 200W, 480m**

The all-new rugged STRIKER fishfinder series with high-sensitivity GPS are designed to allow you to mark your favourite fishing spot and easily navigate back to it tomorrow, saving you time and money. All of the STRIKER series devices offer CHIRP traditional sonar, which show crisp fish arches with excellent target separation. The STRIKER "dv" series adds CHIRP DownVü to provide clear images of structure below the boat. The STRIKER 7sv adds CHIRP DownVü and CHIRP SideVü scanning sonar to find structure to each side of the boat. Use the split screen view to show the waypoint map and various sonar options or create customized sonar views simultaneously.

- Offers a keyed interface with dedicated buttons. The device is easy to use and easy to install
- New rugged, outdoor look to compliment your lifestyle. Able to withstand the harsh marine environment with excellent performance.
- The built-in GPS receiver allows you to mark your favorite fishing spot and get back to it tomorrow. This also allows the device to display GPS speed so you know how fast you are trolling.
- Use the waypoint map to easily view, mark and navigate to locations such as fishing spots, fishing gear and docks.
- Instead of sending just one single frequency, CHIRP sends a continuous sweep of frequencies ranging from low to high. CHIRP sonar technology then interprets frequencies individually upon their return. Since this continuous sweep of frequencies provides a wider range of information, CHIRP sonar is able to create crisper fish arches with greater target separation.
- Allows the device to tilt and swivel for an optimum viewing angle. An optional flush mount kit can be purchased to have a sleeker install on your dash.
- View your sonar data in the classic flasher format. Ideal for ice fishing or vertical jigging.
- The optional portable kit makes it easy to use this device for ice fishing or on a kayak.
- All STRIKER fishfinders include everything you need in the box to start fishing - including a transom/trolling motor mount transducer. You can also choose from a wide variety of optional transducers for any type of installation and fishing experience.
- Supports Minn Kota® and MotorGuide® trolling motors with integrated transducers.
- Utilize the optional User Data Sharing Cable to share your favorite waypoints and routes between compatible STRIKER and echoMAP devices.

Display Size (diagonal): 3.5" / Display Resolution: 480 x 320 HVGA / Included Transducer: Dual Beam (CHIRP 77/200 kHz) / Transmit Power: 200 W (RMS), 1,600 W (Peak to Peak) / Frequencies Supported (kHz): Traditional: 50/77/200 CHIRP (mid-band, high) / Maximum Depth Capabilities with included transducer: 1,600 ft. (traditional)



Code | 65774

Electronics & Navigation

## Chartplotters/Fishfinder/GPS

Available only in certain countries



Code | 65788

### Garmin Fishfinder Plotter ECHOMAP Plus 62cv, with chart Vision Greece G3

Following the success of the echoMAP CHIRP combo series, Garmin is proud to announce the new ECHOMAP Plus chartplotter/sonar combo series delivering industry leading sonar technology and feature rich cartography you've come to know and trust.

- Built-in wi-fi
- New 6-inch screen
- CHIRP traditional
- CHIRP ClearVü and CHIRP SideVü scanning sonars for nearly photographic images of what's below the boat
- A single microSD card slot provides expandable memory for accessory map purchases
- Internal 5 hz gps
- NMEA 2000® compatible
- Quick-release mount

## VHF

Available only in certain countries



### Marine VHF 115i

Communication is critical on the water. This radio plugs and plays via the NMEA 2000® network to compatible Garmin chartplotters and MFDs to provide standard Class D Digital Selective Calling (DSC) functionality. With 25 W transmit power and built-in GPS, they give fishermen, sailors and cruisers confidence at their fingertips in an emergency situation.



Code | 63576

#### Key Features:

- Built-in GPS
- Fixed-mount with plug and play via the NMEA 2000 network; can also be connected via NMEA 0183
- Digital selective calling - Standard Class D Digital Selective Calling (DSC) functionality (distress calling and direct calling with user programmed MMSI).
- 25 W of transmit power at your fingertips
- Programmed with international marine channels
- Designed to complement the latest GPSPMAP® 7x2/9x2, GPSPMAP 10x2/12x2, GPSPMAP 7400/7600 and GPSPMAP 8400/8600 chartplotters and MFDs.

## Compasses



### Sea Marine Compass

- Illuminated pivoting compass
- Wired for 12 Volt red illumination
- Visible Lubber Line
- With Adjustable Mounting Bracket
- Adjustable Sun Visor
- Individually balanced dials for Precision
- Fast Response and precision Engineering
- Corrosion Resistant
- Waterproof, durable and long lasting
- Built in Accuracy compensators
- Windshield or Dash Mount
- Easy to read precision dial
- With Mounting screw slot
- Suitable for Watercraft, Boat, Caravan and Truck

### Compass with LED Light, 102x94x137mm

Code	72111	72112
Colour	Black	White

#### To adjust

Locate the slotted compensator. Adjust knobs at the middle and side of the base. When received, the factory preset knobs should be in neutral (horizontal) position

To exert maximum effect on compensators, turn knob 90° to positive (vertical) position



### Compass Supersport 3 3/4"

Developed for and tested on offshore race boats the SuperSport Series compasses feature the PowerDamp® Plus dial. This dial technology features the PowerDamp® dial skirt to prevent oscillation, larger DirectiveForce™ magnets for quick lock on and extra-large steel pivots and jewels for smooth fast action.

#### Specifications

Boat Style	Offshore race boat
Dial Size/Design	3 3/4" (9.4cm)/Blue PowerDamp Plus Flat-Card
Night Lighting	12V Green
Compensators	Built-in
Mounting Hole	4" (10.2cm) - 5" (12.8cm)
Warranty	5-Year
Approx. Shipping Wt.	2lb. (907g)

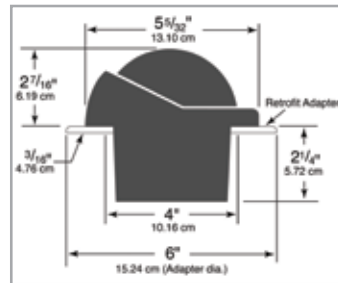

Code	72269
Colour	White



### Compass Navigator BN-202 Bulkhead Mount

For those adventurous sailors, who seek perfection in every item, and device on their boat, the Navigator BN-202 is ideal. Rugged manufacturing, dynamic design, built-in clinometer, and easy to read card are just a few of the features that this compass is equipped with.

#### Specifications

Boat Style / Size	Sail / From 28ft to 45ft (9,15m to 13,73m)
Dial Size / Design	4 1/2" (11,43cm) / CombiDial
Night Lighting	12-Volt Green
Compensators	Built-in
Mounting Hole	5 3/4" (14,61cm)
Warranty	5-Year
Approx. Shipping Wt.	2lb. 5oz. (1,05kg)

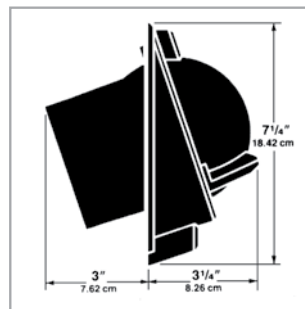

Code	31366
Card Colour	Red
Cover Colour	Black



### Compass Venture SR-2 Bulkhead Mount

Designed for sailboats from 4.90 to 10.70m. Supplied with Clinometer (INC- 45)

#### Specifications

Boat Style / Size	Sail / From 16 to 36ft (4,88m to 10,68m)
Dial size	3 3/4" (9,35cm)
Design	CombiDial
Night Lighting	12V Green LED
Mounting Hole	4 5/8" - 4 13/16" (118 - 122mm)
Warranty	5 years

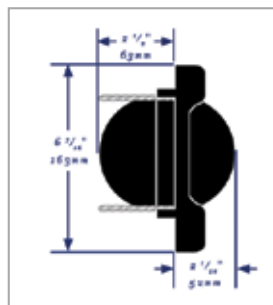

Code	31199
Card Colour	Blue
Cover Colour	Black



### Compass Voyager B-81, with Bracket Mount

#### Specifications

Boat Style/Size	Power
Dial Size/Design	3" (7,6cm)/Flat-Card or CombiDial
Night Lighting	12V Green
Compensators	Built-in
Warranty	5-Year
Approx. Shipping Wt.	1lb. 8oz. (680g)

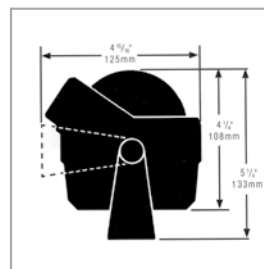

Code	71156
Colour	Black



The Wheelmark Symbol denotes conformance with Standard ISO 10316(E) and ISO 613:2000(E).





## Compass Explorer B-51

Ritchie accuracy and mounting versatility are the perfect combination with Explorer Bracket Mount Compasses.

### Specifications

Boat Style/Size Power/Up to 24ft (7.32m)  
 Dial Size/Design 2 3/4" (6.99cm)/Direct Read  
 Card Type Conical  
 Night Lighting 12V Green  
 Compensators Built-in  
 Warranty 5-Year  
 Approx. Shipping Wt. 1 lb. (454g)

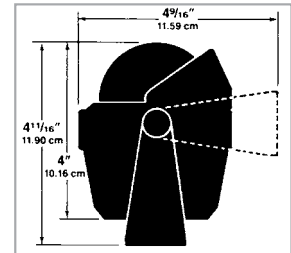

Code	31240	31241	31242
Description	Explorer B-51	Explorer B-51W	Explorer B-51G
Colour	Black	White	Grey



Electronics & Navigation



## Compass Explorer S-53

The Explorer Surface Mount compasses combine size and accuracy with a push button system for easy-on mounting, easy-off storage and security.

### Specifications

Boat Style/Size Power/Up to 24ft (7.32m)  
 Dial Size/Design 2 3/4" (6.99cm)/Direct Read  
 Card Type Conical  
 Night Lighting 12V Green  
 Compensators Built-in  
 Warranty 5-Year  
 Approx. Shipping Wt. 1 lb. (454g)

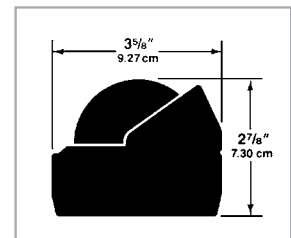

Code	31250	31251	31252
Description	Explorer S-53	Explorer S-53W	Explorer S-53G
Colour	Black	White	Grey

## Compass Sport X-10-M

Mount it on your deck. Mount it on your windshield. Mount it on your dash. Here's a compass that's just the right size for small power boats.



Code	31200	31201	31202
Description	Sport X-10-M	Sport X-10B-M	Sport X-10W-M
Colour	Grey	Black	White



### Specifications

Boat Style/Size Power/Up to 16ft (4.88m)  
 Dial Size/Design 2" (5.08cm)/Direct Read  
 Card Type Conical  
 Night Lighting 12V Green  
 Compensators Built-in  
 Warranty 5-Year  
 Approx. Shipping Wt. 5 oz. (142g)

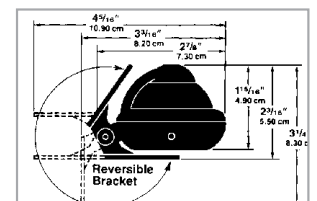

The fully adjustable and reversible Bracket allows a mounting range of over 3000 from over head, through angled and vertical mounts to horizontal surfaces. These mounting position options and your choice of mounting hardware permit mounting from windshield or supporting frame structures, to slanted dash boards and consoles to almost any flat, angled or vertical surface.





### Compass Explorer V-537 Bulkhead Mount

Just another small wonder for your sailboat. Designed and constructed especially for sailboats up to 7m.

Code	31362	31363	31364
Description	V-537W	V-537	V-537B
Colour	White	Black	Blue

#### Specifications

Boat Style / Size	Sail / Up to 24ft (7.32m)
Dial Size / Design	2 3/4" (6.99cm) / Direct Read
Card Type	Conical
Night Lighting	12V
Compensators	Built-in
Mounting Hole	3" (7.62cm)
Warranty	5-Year
Approx. Shipping Wt.	1lb. (454gr)

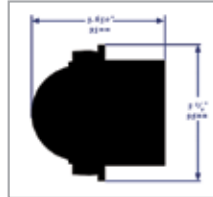

### Compass Sport X-21 Bulkhead Mount

Just another small wonder for your sailboat. Designed and constructed especially for sailboats up to 7m.

Code	31359	31360	31361
Description	X-21W	X-21	X-21B
Colour	White	Black	Blue

#### Specifications

Boat Style / Size	Sail / Up to 24ft (7.32m)
Dial Size / Design	2 3/4" (6.99cm) / Direct Read
Card Type	Conical
Night Lighting	12V
Compensators	Built-in
Mounting Hole	3" (7.62cm)
Warranty	5-Year
Approx. Shipping Wt.	1lb. (454gr)

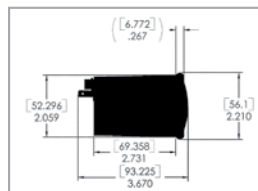

## Hand Bearing Compasses



### Hand Bearing Compass, Non-Magnetic Alloy

- Compass rose with 360° scale
- North Line with north arrow
- Rotary dial with 360° scale
- Sighting window with sighting line
- Bubble Level
- Base table
- Stand thread
- Inch Scale
- Cm Scale
- Lens prism
- Lid
- Housing

Code | 99984



Code | 71207

### Hand Bearing Compass SportAbout X-11 with Sialum Slot, Yellow

- Easy to Read 2" Direct-Reading Dial compass, with neck lanyard
- Hardened Steel Pivot and Sapphire Jewel Movement
- Built-in Roller Diaphragm for Extended Temperature Operating Range
- QuickSight V-Notch and Lubber Line for Easy Heading Alignment
- Non-Electric Chem Sticks Provide 18 Hours of Night Lighting
- International Safety yellow case, made of Impact-Resistant Silicon
- Compact Size for Easy Handling and Storage



## Terrestrial Omnidirectional TV Radio Antenna, with 27,5 dB Gain Average

The most popular Glomex TV Antenna has been chosen as standard equipment by all major boat builders worldwide. A revolutionary state of the art antenna element and amplifiers produces exceptional performance on all channels, including the lower VHF frequencies. The 99643 TV antenna is supplied with the amplifier, including the flush, 15m of low loss, twin screen 75 Ohm coaxial cable, 1,5m TV cord and all the F gold plated connectors for the installation on board. Combined with the additional 99644 Splitter (sold separately) enhances its functionality and is able to receive radio programs as well.  
Antenna Diameter: 370mm, Antenna Height: 240mm



Code | 99643



## Two Way Splitter, for 99643 & 99645 Antenna



Code | 99644

## Terrestrial Omnidirectional TV Radio Antenna, Glomex, with 26 dB Gain Average

This compact, lightweight TV antenna features exceptional performance on all TV frequencies. Made of UV resistant injection moulded nylon, it will keep its white mirror like finish for years. Like other TV antennas, the 99645 has no active components in the antenna, which provides extra protection from atmospheric elements. The 12/24V power supply amplifier is totally screened. This allows the best reception of TV signals with less interference from shipboard electrical noise sources. Combined with the additional 99644 Splitter (sold separately) enhances its functionality and is able to receive radio programs as well.  
Antenna Diameter: 250mm, Antenna Height: 151mm



Code | 99645



## AM-FM Antenna, L 1,5m, 6m Coaxial Cable & Motorola Plug (AM 550-1600 / FM 88-108 Mhz)

- Length: 1,5m
- Glossy fiberglass
- Nylon ferrule
- Solid antenna elements

Code | 99652



Electronics & Navigation

## VEGA Omnidirectional TV Antenna, with 25dB Gain Average

When you require a compact antenna or want a sleek low profile without the bulky weight of a large antenna, then 70876 TV antenna is the perfect solution. It is made of ASA, can withstand the harsh marine environment and with a totally screened, low noise amplifier, built in the antenna case, it ensures that you'll have the best reception possible for VHF and UHF frequencies, in both analogue and digital channels. It is supplied with the power inserter, plastic mount, 10m of low loss coaxial cable (75 ohms) and the 1.5m TV cord. Includes Splitter for TV & Radio.

- Antenna Diameter: 100mm
- Antenna Height: 210mm
- Base Diameter: 25mm
- Frequency Range: 40/890 MHz
- Gain Average: 25dB
- Power Supply: 12V



Code | 70876

## AM-FM Antenna, L 0,3m, 3m Coaxial Cable, Motorola Plug & Built-in Mount

(AM 550-1600 / FM 88-108MHz)

- Length: 0,30m
- Unbreakable UV resistant synthetic rubber injection moulded
- Solid antenna element
- Built-in mount and ground plane built-in on the coax



Code | 99654



new



## Antenna Satellite TV, 390mm

Code | 41635

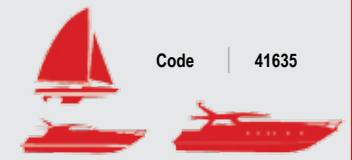



**VHF Antenna, with 3dB Gain Average & PL259 Connector, L 0,9m**

The VHF 3DB MASTHEAD 0.9m antenna belongs to the ALOUD product line. There is no compromise in the manufacturing of these antennas, while its tapered stainless steel whips can absorb physical shocks without bending. The antenna is supplied with all the necessary parts for installation and a high quality RG58 C/U (MIL C17) coax cable. The Glomex exclusive weatherproof solderless connector allows installation without soldering, so it simplifies the replacement of existing antennas. These antennas are approved for marine use on grounded and ungrounded installations (sail and power boats).

Code | 71114



**VHF Antenna, with 3dB Gain Average, L 0,9m, 18m Coaxial Cable & PL259 Connector**

There is no compromise in the manufacturing of these antennas (Aloud series). The tapered stainless steel whips can absorb physical shocks without bending. The fiberglass version has a glossy polyurethane coating to provide extra corrosion protection for the internal copper elements. These individually tuned antennas are supplied with all the necessary parts for installation.

Code | 99646



**VHF Antenna, with 3dB Gain Average, L 1,5m, 4,5m Coaxial Cable & PL259 Connector**

This 5/8 wave antenna is the right choice for small boats where exceptional value at an economic price is the primary concern.

- Length: 1,5m
- Solid brass antenna elements
- 4,5m Coaxial cable
- Glossy Glomex fiber-glass
- Nylon ferrule

Code | 99647



**VHF Antenna, with 6dB Gain Average, L 2,4m, 4,5m Coaxial Cable & PL259 Connector**

Glomex has set a new standard for quality in lightweight, economic VHF antennas with the 99650. The standard features of the CLASSIC range make this the best choice for the value minded boater.

- Length: 2,4m
- Glossy Glomex fiber-glass
- Solid brass antenna elements
- Electro polished stainless steel ferrule
- 4,5m Coaxial cable
- Remforced tube of 1,2mm thickness
- Glue protection rubber collar
- Safety tip synthetic rubber

Code | 99650



Electronics & Navigation

## Communications Accessories

**new**

**WeBBoat 4G Lite, 3G / 4G / WI-FI, Coastal Internet System**

Code | 74389

**Zigboat Basic Kit, Wireless and Remote Surveillance and Monitoring System**

Code | 41634

## Communications Accessories

**new** AIS Antenna with 3dB Gain Average, Fiberglass, L 1m Code | 41633



**GLOMEX**

## Connectors & Coaxial Cables

**new** FME Male to FME Adaptor Code | 41636

Male to PL259 Male Adaptor Code | 41637

Female to SO239 Female Adaptor Code | 41638

Female to SO239 Female Adaptor Code | 41648

Coaxial feed for PL Connectors, Gold Plated Code | 41639

Coaxial Cable, Low Loss 50 Ohms

Code	Length (m)
41640	3
41641	6
41642	12
41643	18
41644	24
41645	30

Coaxial Cable, Low Loss 93 Ohms

Code	Length (m)
41646	6
41647	18

**GLOMEX**

PVC Threaded Protection for all size PL259 Connectors Code | 99667



PL259 Connector for RG58/U Coax Cable, Twist-on Code | 99666



## Antenna Mounts & Accessories

Mount for TV Antenna 99643 & 99645, Electropolished Stainless Steel   
 Diameter 25mm Code | 99662



Feed-Thru for Deck Passage of Coaxial Cables & Connectors (type RG58), Nylon Code | 99664



**GLOMEX**

Mount for TV Antenna 99645, Electropolished Stainless Steel   
 Diameter: 25mm Code | 99663



**new** Universal Mount, L 150mm, Diam 25mm, Stainless Steel Code | 41649





**Four Way Antenna Ratchet Mount, Electropolished Stainless Steel, for 1"x14 Thread, Locking by Handle**



Code | 99658

Ratchet mount-polished stainless steel. Four way ratchet mount for installation on deck or bulkhead, locking by handle. Hole for Lorax or GPS cable. The exclusive built-in feed-thru allows the passage of coaxial cable. Standard thread 1"x 14.



**Four Way Antenna Ratchet Mount, with 2 Adjustment Knobs**

This ratchet mount antenna is made of reinforced nylon and can be fixed to the deck or bulkhead of your boat. Its two knobs allow you to adjust the antenna in several positions either vertically or horizontally. Set the antenna at the position of your preference and lock its knobs manually. A special rift on the top of the antenna is appropriate for coaxial and GPS cables. It is available in white colour.



Code | 99657



**Four Way Antenna Ratchet Mount, with Adjustment Knob**

This ratchet mount antenna is made of reinforced nylon and is installed on the deck or bulkhead of your boat. It has one knob, which moves horizontally and it locks manually at the position of your preference. It is available in white colour.

Code | 98697

**Antenna Rails Mount, with 2 Adjustment Knobs**

This rail mount is made of reinforced nylon and is fixed to fit on rails of 19.1-25.4mm diameter. It has two adjustable knobs with which you achieve complete horizontal and vertical motion of the antenna. Two nuts on the side of the mount allow you to lock the position of the antenna. It has a special rift to hold coaxial and GPS cables.



Code | 70144



**Four Way Antenna Ratchet Mount, with Adjustment Knob**

This ratchet mount is made of reinforced nylon and it is installed on rails of 19.1 up to 25.4mm diameter. The ratchet mount includes a single knob, so that you can adjust the horizontal position of the antenna manually. It is available in white colour.

Code | 98698



Code | 99740

**Antenna Mount, H 100mm, Diam. 70mm**

Made of reinforced nylon



Code | 99660

**Antenna Rails Ø19,1-25,4mm mount, H 65mm**

Made of reinforced nylon



Code | 98692

**Fixed Antenna Mount, H 41mm, Diam. 70mm**

Made of reinforced nylon



**Antenna Bracket for Rail Ø18-27mm, Plastic, White**

Code | 43257



**Bracket for VHF Microphone**

Code	Colour	Length (mm)	Height (mm)	Width (mm)
44532	White	35	8	35
44533	Black			

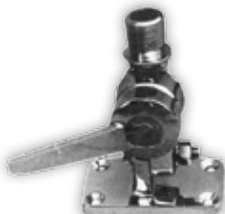

**Ratchet Mount Antenna Base, Inox 316**

Dimensions: 63x92mm, Height: 110mm

Code | 98684



**Fixed Antenna Base, Inox 304**

Diameter: 73mm, Height: 102mm

Code | 98688



Electronics & Navigation



**Waterproof Radio/MP3 Player 4x20Watt - LCD - AUX - Bluetooth**

Marine USB/MP3 Player, Black, Radio AM/FM, Output auxiliary 4x20Watt, Clock, Input AUX, Green-lighted/LCD high resolution display.

- Marine USB/MP3 Player
- Radio AM/FM
- Clock
- Fully waterproof-complies with the instructions ASTM B117 Salt/Fog exposure & ASTM D4329 UV
- Water-tight/high quality rubber buttons,
- Possibility of support behind the console

**Dimensions:**  
front diameter 87mm, hole diameter 76,5mm, depth 58mm

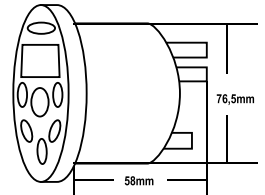
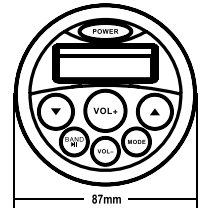

**Package Includes:**

- 1 Audio source
- Mounting bracket with fixing screws
- Connection cables for speaker
- USB Cable - 1m
- User Manual



Code | 63765



Electronics & Navigation



**Case Cover for Radio/CD**

Ideal to protect the Radio/CD player of your boat. Suitable for all 1 DIN (180mm x 50mm) units of the market. Options in white colour with flat cover, and in smoked transparent colour with flat or curved cover.



Code	Colour	Cover Type
50281	White	Flat
195265	Smoked transparent	Flat
196069	Smoked transparent	Curved

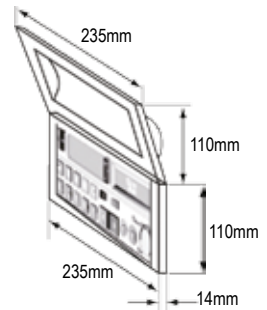

Marine Speakers & Megaphone



**Megaphone with Siren**

- Diameter: 200mm
- Length: 350mm
- Power: 20W
- Sound Coverage: 400m approx.
- Function: Talk/Siren (or Music)
- Batteries: 6D
- ABS Housing



Code | 90168



new

**Two-way Speakers, 100W, 6 1/2", Non-magnetic, with Clip-on Cover, White, Set**

Ideal for use in boats, the Two-way Speakers are waterproof and corrosion-resistant while they can be hosed down when the boat is being cleaned. Having non-magnetic design, they don't disturb instruments or compasses and their ASA cover provides improved endurance in both sea and sun exposure. They also feature waterproof and corrosion-resistant mica injection cone with TPU edge and corrosion-resistant silicone coated terminal wire. Can be mounted either horizontally or vertically. Suitable for indoor and outdoor use. Available in white colour. CE approved.

**Technical Specifications:**

- Impedance: 4 Ohm
- Sensitivity: 90 dB
- Frequency Response 60-18000 Hz
- Max Power 100W (per pair)
- RMS Power 80W (per pair)

**Mounting Dimensions:**

- Depth: 64mm
- Hole diameter: 136mm
- Magnet: 350g (8oz + 4.3oz)



Code | 74576

**2 Way Speaker Set**

With Nuova Rade Speakers installed in your boat, you can relax or party - listening to your favourite music. Ideal for use in boats, since they are water (31302 & 31303) and corrosion proof. The 2-way speakers may be mounted both indoors and outdoors.

**Technical Specifications**

**31302**

- 5 1/4" 2 Way Speaker Set 80W
- Impedance: 4 Ohm
- Sensitivity: 88db
- Frequency Response: 80-18000 Hz
- Max: 80W (per pair)
- RMS Power: 70W (per pair)
- Material: UV-stabilised ABS plastic
- Dimensions: 5,25"(13,34cm)

**Mounting Dimensions**

Depth: 53mm, Hole: 115mm  
Magnet: 238g (5.4oz + 3oz)

**31303**

- 6 1/2" 2 Way Speaker Set 100W
- Impedance: 4 Ohm
- Sensitivity: 90db
- Frequency Response: 60-18000 Hz
- Max: 100W (per pair)
- RMS Power: 80W (per pair)
- Material: UV-stabilised ABS plastic
- Dimensions: 6,5" (16,5cm)

**Mounting Dimensions**

Depth: 64mm, Hole: 136mm  
Magnet: 411g (8oz + 6.5oz)



Code	31302	31303
Diameter (Inches)	5' 1/4"	6' 1/2"
Power (W)	80	100
Colour	White	White



Electronics & Navigation

Binoculars



**Binoculars, Individual Focus, 7x50, with Compass, Waterproof, Floating**

- The ultimate marine binoculars
- Waterproof, floating & shockproof
- With compass
- Brighter images
- Individual focus
- Foldable eyecups
- Easy-to-use
- With neck strap, carrying case and built-in lenses' cover

**Technical Specifications**

- Magnification: 7x
- Lens Diameter: 50mm
- Prism Type: Porro BAK-4
- Angle of Vision: 7,3o
- Exit Pupil: 7mm
- Eye Relief: 21,1mm
- Focus Type: Individual
- Field of View: 127m@1000m
- Weight: 914gr
- Dimensions: 17x9,5x20cm
- Battery: LR43



Code | 31367

## Binoculars



Code | 31317

### Binoculars, Center Focus, 7x50

- The most user-friendly binoculars
- Brighter images
- Center focus
- Rubber fold-down eyecups
- Lightweight & easy-to-use
- Soft bag, strap & lens cleaning cloth are included in the package

#### Technical Specifications:

- Magnification: 7x
- Lens Diameter: 50mm
- Prism Type: Porro BAK-4
- Angle of Vision: 6.6°
- Exit Pupil: 7,14mm
- Eye Relief: 20mm
- Focus: Center focus
- Field of View: 114m@1000m
- Weight: 873gr
- Dimensions: 19x6x17,5cm



new



Code | 74620



### Night Vision Binoculars, Digital, 8x31, with Rechargeable Battery, Video Rec, Incl. 8GB SD Card

- Digital binoculars
- Can be used for observation in completed darkness or low-light conditions
- With video recording capability & rechargeable battery
- 8GB SD Card included

#### Technical Specifications:

- Magnification: 8x
- Lens Diameter: 31mm
- Exit Pupil: 45mm
- Angle of Vision: 9°
- Weight: 580gr (without battery)
- Dimensions: 22x14x6cm
- Viewing Range: 2m-∞ in daytime, up to 400M (monochrome) in the darkness
- Resolution: 1280x720
- Resolution TFT LCD: 640x360



## Navigation Instruments

### One Hand Dividers

These dividers can be opened and closed with one hand, while performing your chart work. The top curved part of the handle is brass and the tapered sides are bright finished marine alloy. They are believed to be the best marine dividers available.



Code	93968	93969
Length	17,8cm (7")	20,3cm (8")

### Straight Pattern Brass Dividers

Dividers is a necessary tool in distance calculation, and generally in navigating the boat. Lalizas dividers are made of bronze arms and tips with special metal alloy, for extra resistance. They are available in two sizes 17,8cm (7") and 20,3cm (8").



Code	94003	94004
Length	17,8cm (7")	20,3cm (8")

### Parallel Ruler



Code	94008	94009
Length	38cm (15")	30cm (12")



## Chart Protractor Bi-Rola, 5-1/8"x15-1/4"

This bi-rola chart protractor turns the tedious task of plotting into child's play. It virtually eliminates the need for other devices except a pencil. Plotting a course is as simple as laying the protractor along your course line and aligning the compass disk. Laying off courses, bearings, distances and loran interpolation is so easy you can forget about other methods. Corrections can easily be made for variation and deviation. The body of the contractor has scales for nautical miles, millimeters and loran interpolation.

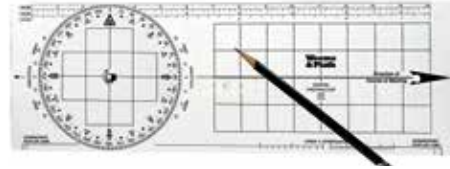

Code | 95674

## Triangular Protractor 45° with Handle

Using two 45° triangles provides an easy method of plotting and performing other chart work. With its protractor scales, the triangle is easily aligned in any direction with a chart meridian. Direction is maintained as one triangle slides on the other, to the desired position. Durable, clear vinylite.



Code | 93991

# Cruising Charts & Pilot



Available only in certain countries



Digital Chart,  
SD Card,  
Greece Area, GOLD  
D-L SMALL

Code | 65786

Digital Chart, SD Card,  
Mediterranean & Black Sea MSD/NAV+43XG



Code | 65787

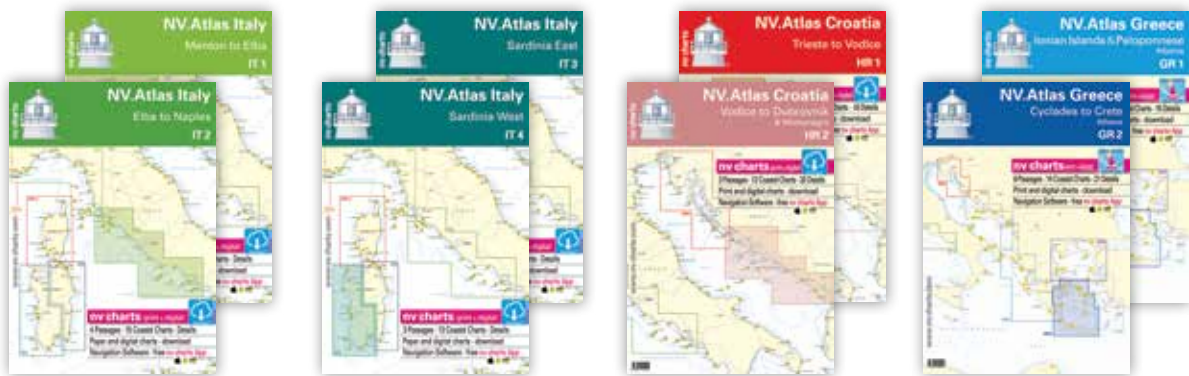

## NV Print and Digital Chart

Code	Description
73710	NV Print and Digital Charts - Atlas Italy - Menton to Elba (IT 1)
73711	NV Print and Digital Charts - Atlas Italy - Elba to Naples (IT 2)
73712	NV Print and Digital Charts - Atlas Italy - Sardinia East (IT 3)
73713	NV Print and Digital Charts - Atlas Italy - Sardinia West (IT 4)
73714	NV Print and Digital Charts - Atlas Croatia - Trieste to Vodice (HR 1)
73715	NV Print and Digital Charts - Atlas Croatia - Vodice to Dubrovnik & Montenegro (HR 2)
73716	NV Print and Digital Charts - Greece - Montenegro to Cape Maléas & Peleponnese (GR 1)
73717	NV Print and Digital Charts - Greece - Cyclades to Crete & Athens (GR 2)



Electronics & Navigation



**Eastern Mediterranean Chart**

Code	Description
99881	Eastern Mediterranean M20, "Eastern Mediterranean"
99882	Eastern Mediterranean M21, "South Coast of Turkey, Syria, Lebanon & Cyprus"
99883	Eastern Mediterranean M22, "Egypt to Israel, Lebanon and Cyprus"
99884	Eastern Mediterranean M23, "Adriatic Sea"
99888	Western Mediterranean M10, "Western Mediterranean"

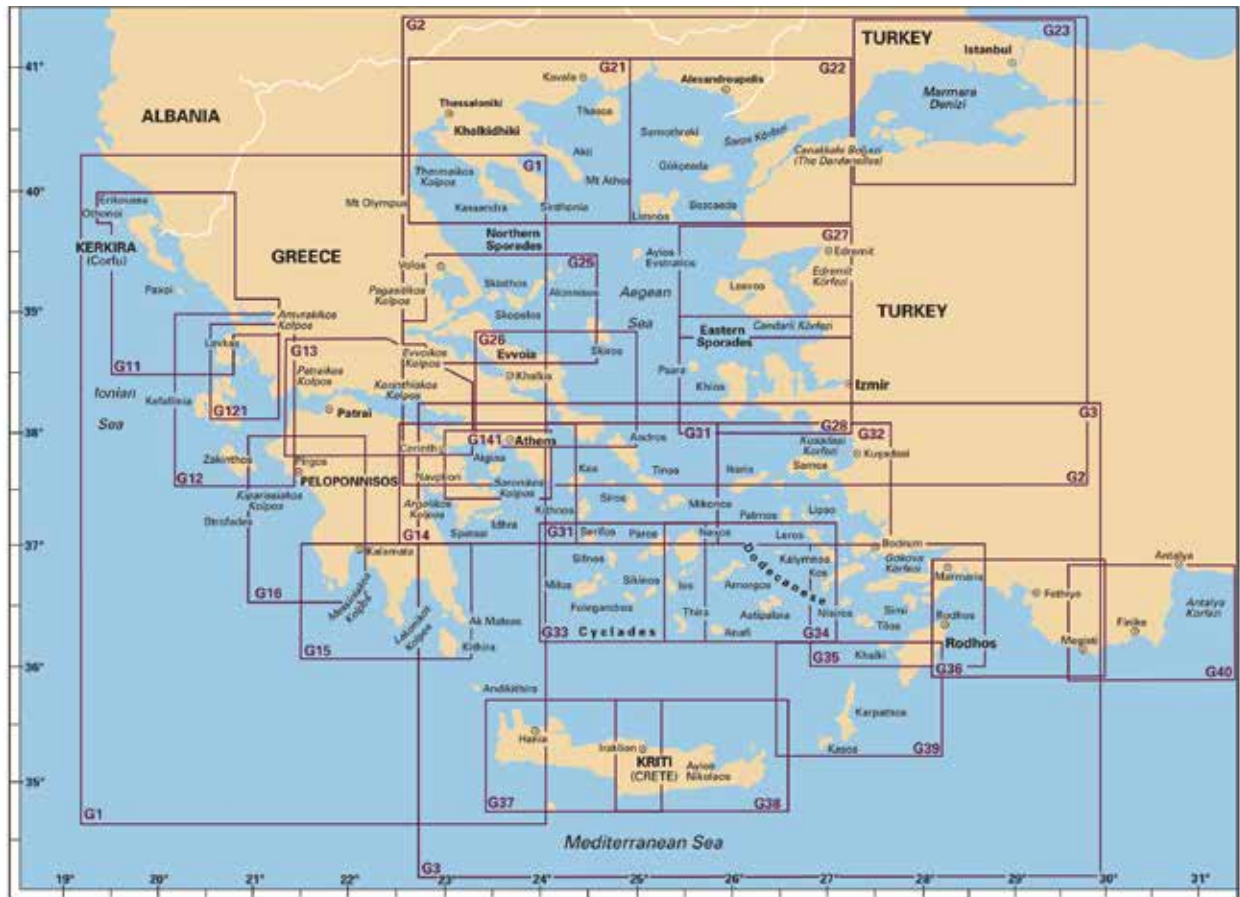

**Tetra Chart Greece -Turkey**

Code	Description
99856	Greece G1, "Mainland Greece and Peloponnese"
99857	Greece G11, "North Ionian Islands"
99858	Greece G12, "Nisos Levkas to Nisos Zakynthos"
99859	Greece G121, "Inland Sea - Ionian"
99860	Greece G13, "Gulf of Patras and Corinth"
99861	Greece G14, "Saronic and Argolic Gulfs"
99862	Greece G141, "Saroniōs Kolpos"
99863	Greece G15, "Southern Peloponnisos"
99864	Greece G16, "Western Peloponnisos"
99865	Greece G2, "Aegean Sea (North Part)"
99866	Greece G25, "Northern Sporades and North Evvoia"
99867	Greece G26, "Nisos Evvoia"
99868	Greece/Turkey G27, "Nisos and the Coast of Turkey"

Code	Description
99869	Greece/Turkey G28, "Nisos and the Coast of Turkey"
99870	Greece G3, "Aegean Sea (South Part)"
99871	Greece G31, "Northern Cyclades"
99872	Greece/Turkey G32, "Southern and the Coast of Turkey"
99873	Greece G33, "Southern Cyclades"
99874	Greece G34, "Southeastern Cyclades"
99875	Greece/Turkey G35, "Dodecanese the Coast of Turkey"
99876	Greece G37, "Nisos Kriti (West)"
99877	Greece G38, "Nisos Kriti (East)"
99878	Greece G39, "Nisos Karpathos to Nisos Rhodes"
71329	Greece G21, "Northwest Aegean"
71330	Greece G22, "Northeast Aegean"
99879	Turkey G40, "South Coast of Turkey"
99880	Turkey G36, "Marmaris to Kekova Adasi"



**Croatia Chart**

Code	Description
70136	Croatia M24, "Golfo di Trieste to Losinj & Rab"
70137	Croatia M25, "Rab to Sibenik"
70138	Croatia M27, "Dubrovnik to Bar & Ulcinj"
70963	Croatia M30, "Southern Adriatic & Ionian Seas"

**Available only in certain countries**

**Maps, Guides and Books**

Lalzas offers you pilot maps, guides, and other such as Regulations slide rules, published by N. D. Elias. All articles included in this range have useful information for the navigation, and the ports in Greece. They are unique in the market because all the information provided, such as instructions of land approach, dangerous locations, and many more (excluding pilot maps), have been collected and verified with on the spot research by the publishers themselves, and not taken by third parties or organizations. Another feature, not found in other similar publications in the market, is the fact that the pilot maps, and the photos are all in colour and not black and white, allowing you to read them easily.

**Sea Guide**

These Sea Guides provide you with all the information that one may need on board a boat. They include pilot maps, detailed data on ports, gulfs and all possible anchorage locations. Furthermore, they feature information on the winds in the respective area, as well as information on food, entertainment, and sleep. The Sea Guides are made of reinforced paper, hand-binded, so that they last longer without being worn out or torn apart. They are available in 4 editions, covering all the seas in Greece.



**Hellas, Sea Guide, "Eastern Peloponnese, Cyclades, Crete & Saronikos"**

Code | 60218



**Hellas, Sea Guide, "Northern Aegean Sea"**

Code | 60219



**Hellas, Sea Guide, "Northern Aegean Sea"**

Code | 60221



**Hellas, Sea Guide, "Dodekanisa"**

Code | 60220

**Pilot Map**

Pilot maps are of course one of the must-have-on-board items, since without them navigation would be almost impossible. The Lalzas Pilot Maps offer complete and updated information for your easy navigation in Greek waters. They also feature instructions for the entrance and exit from ports, with photos. They are made of laminated paper, specially processed so that it is completely waterproof, and that it is not worn out from the extensive use, or the weather conditions at sea. There are many pilot maps available, covering most of the Greek waters. All you have to do is choose.



Code	Description
60222	No 1, Saronikos Bay
63077	No 2, Eastern Peloponisos
63078	No 3, Northern Cyclades
63087	No 4, Southwestern Cyclades
63088	No 5, Southeastern Cyclades
63206	No 6, Euboean Bay
63207	No 7, Corinthian Bay
63257	No 8, Bay of Patraikos, Ithaca, Cephalonia
63343	No 9, Pagasitios Bay - Sporades
63344	No 10, Western Crete
63345	No 11, Eastern Crete
63464	No 12, North Dodecanese
63532	No 13, South Dodecanese
63533	No 14, North-West Aegean Sea
63558	No 15, Thracian Seaç
63559	No 16, South-East Euboea up to South Chios & South Lesbos
63268	General Pilot Map, No 1, South Aegean Sea
63341	General Pilot Map, No 2, Ionian Sea
63342	General Pilot Map, No 3, North Aegean Sea



Electronics & Navigation

Available only in certain countries



## Guide for Collision Regulations, 'Abacus'

The 'Abacus' is a very useful item to have on board. The captain and anybody else using it can easily and quickly locate and be informed about any part of the COL.REG, thus helping in a smoother and safer navigation of the boat. Available in Greek and English.

Code	Description
60223	In Greek
63089	In English

## Coastal Chart

Coastal charts show the area of the Adriatic Sea - eastern coast at scales of 1:50000 to 1:100000. They include Small charts of 1:100000 scale, which are small-sized and suitable for smaller vessels. They are available only in sets (MK-1 and MK-2).

Code	Description	Scale 1:	Format
100-15	Grado - Rovinj	100000	B1
100-16	Pula - Kvarner	100000	B1
100-17	Lošinj - Molat	100000	B1
100-18	Rijeka - Kvarnerić	100000	B1
100-19	Silba - Pag	100000	B1
100-20	Dugi otok - Zadar	100000	B1
100-21	Šibenik - Split	100000	B1
100-22	Jabuka - Vis	100000	B1
100-23	Tremiti - Palagruža	100000	B1
100-24	Palagruža - Lastovo	100000	B1
100-25	Hvar - Lastovo	100000	B1
100-26	Brač - Hvar	100000	B1
100-27	Peleješac - Mljet	100000	B1
100-28	Dubrovnik - Budva	100000	B1
100-29	Budva - Ulcinj	100000	B1
100-30	Ulcinj - Durres	100000	B1
50-3	Pula - Cres	100000	B1
50-4	Riječki zaljev	100000	B1
50-20	Dubrovnik	100000	B1



copyright © H&E

Description	Scale 1:	Format
Male karte, I dio, komplet, Tršćanski zaljev - Novigradsko more - Zadarski kanal	100000	B3
Male karte, II dio, komplet, Zadar - Ulcinj	100000	B3

## Sailing Chart

Sailing charts show the area of the Adriatic Sea, Ionian Sea and Maltese Islands at scales of 1:150000 to 1:300000.

Code	Description	Scale 1:	Format
INT 3410	Rijeka - Venezia	250000	A0
INT 3412	Split - Gargano	250000	A0
INT 3414	Dubrovnik - Durres	250000	A0
300-31	Venezia - Zadar	300000	B1
300-32	Ancona - Šibenik	300000	B1
300-33	Pescara - Split	300000	B1
300-34	Barletta - Dubrovnik	300000	B1
300-35	Bari - Ulcinj	300000	B1
300-36	Golfo di Taranto - Otrantska vrata	300000	B1
300-37	Otranto - Preveza	300000	B1
151	Rijeka - Venezia	200000	B1
152	Rijeka - o. Murter	200000	B1
153	Šibenik - o. Lastovo	200000	B1
154	Peleješac - Rt Oštra	200000	B1



copyright © H&E



copyright © H&E

## Plan

Plans - show major ports and marinas, bays, coves and passages of the eastern Adriatic coast at scales of 1:2000 to 1:40000.

Code	Description	Scale 1:	Format
13	Zaljev Raša	100000	B1
14	Plominska luka	100000	B1
15	Rijeka	100000	B1
16	Omišaljki zaljev	100000	B1
17	Bakarski zaljev	100000	B1
20	Kvarner - Velebitski kanal	100000	B1
22	Kvarnerić	100000	B1
37	Srednji Jadran	100000	B1
47	Split - Kaštelanski zaljev	100000	B1
63	Ploče	100000	B1

Code	Description	Scale 1:	Format
83	Dubrovnik	100000	B1
512	Kornat - Murter	100000	B1
518	Rijeka Krka i Prokljansko jezero	100000	B1
525	Stonska prevlaka	100000	B1
532	Sedmovrače	100000	B1
533	Šibenski kanal	100000	B1
535	Vis, Stari Grad, Vrboska i Jelsa, Brna, Maslinica, Vela Luka, Prižba, Karbuni, Velji i Mali Lago	100000	B1
536	Kaštelanski zaljev i Pakleni kanal	100000	B1

Available only in certain countries

**Informative & Auxiliary Chart**

Informative charts include particular information important for the navigation in the Adriatic Sea. Auxiliary charts show parts of the Adriatic Sea at scales of 1:300000, 1:400000 and 1:500000. They are used for graphic solutions of certain tasks in navigation and are suitable for coupling.

Informative and auxiliary charts are not subject to the correction by NTM, nor used for navigation.

Code	Description	Scale 1:	Format
B100	Jadransko more, batimetrijska karta	300000	B1
301	Jadransko more, sjeverni dio	300000	A0
302	Jadransko more, srednji dio	300000	A0
303	Jadransko more, ju ni dio	300000	A0
-	Male karte - Jadransko more - istočna obala (spiralni uvez)	100000	B3



copyright © HHI-Split

**Charts**

Charts show a particular navigational area (a part of the Earth's surface), including all the elements necessary for the safety of navigation and orientation at sea. They fall into navigational charts, informative and auxiliary charts. Charts are manufactured on the Mercator projection by Croatian Hydrographic Institute (HHI).

**Navigational Chart**

According to their scale, content and purpose, navigational charts are divided on General charts, Sailing charts, Coastal charts and Plans. Navigational charts are corrected by Penul d.o.o. Split, Croatia.

**General Chart**

General charts show the area of the Mediterranean Sea with a part of the Black Sea and the Ionian Sea at scales of 1:750000 to 1:2500000.

Code	Description	Scale 1:	Format
101	Jadransko more	800000	A0
102	Jonsko more	800000	A0
108/INT 301	Sredozemno more, zapadni dio	2250000	B1
109/INT 302	Sredozemno more, istočni dio	2250000	B1



copyright © HHI



Publications

Available only in certain countries

**Nautical Publications**

Nautical publications include mariner's handbooks which provide information important for the safety of navigation that cannot be represented on charts, and other publications useful to mariners. Nautical publications are intended to be used in conjunction with charts.



**Pilot I - Adriatic Sea - Eastern Coast**



**Pilot for Small Vessels - Part I**



**Pilot for Small Vessels - part II**



**List of Lights and Fog Signals**



**Radioservice for Mariners**



**Nautical Tables**



**Nautical Almanac**



**Tide Tables - Adriatic sea**



**Navigational Aids, IALA System**



**Symbols and Abbreviations**

Available only in certain countries

Publications and Books for Ships

Description
Voditelj brodice - hrvatski jezik
Voditelj brodice - njemački jezik
Međunarodna pravila za izbjegavanje sudara na moru
Radio dnevnik GMDSS (Log book)
Brodski dnevnik
Dnevnik stroja na motorni poriv
Dnevnik vježbenika palube - kadetura
Dnevnik vježbenika stroja - kadetura
Zdravstveni dnevnik
Popis posade

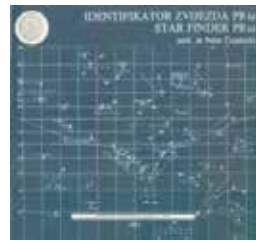

Star Finder

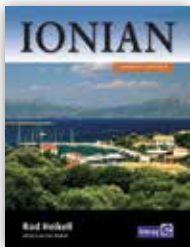

Mediterranean Pilot, "Ionian"

Code | 99839

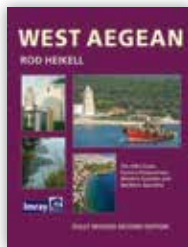

Mediterranean Pilot, "West Aegean"

Code | 99840

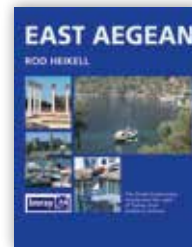

Mediterranean Pilot, "East Aegean"

Code | 99841



Mediterranean Pilot, "Mediterranean Cruising Handbook"

Code | 99836



Mediterranean Pilot, "Greek Waters Pilot"

Code | 99838



Mediterranean Pilot, "Mediterranean France and Corsica Pilot"

Code | 99844



Mediterranean Pilot, "Turkish Waters & Cyprus Pilot"

Code | 99842

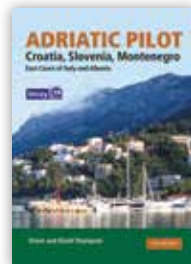

Mediterranean Pilot, "Adriatic Pilot"

Code | 99845



Mediterranean Pilot, "Italian Waters Pilot"

Code | 99846

Available only in certain countries



Practical First Aid

Code | 71003

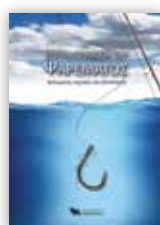

The Complete Fishing Bible

Code | 71002



Book, "Ropes & Knots"

Code | 60224



Available only in certain countries



"Wind Strategy",  
Fernhurst

Code | 99895



"First Aid Manual",  
Dorling  
Kindersley

Code | 99901



"International  
Collision  
Regulations",  
RYA

Code | 99891



"Go  
Sailing",  
RYA

Code | 99894



"Knots &  
Splices",  
Fernhurst

Code | 99898



**Imray**  
Mediterranean  
Almanac

Code | 99851



The Gourmet Sailors  
Handbook, English  
Edition

Code | 71001

Log Books



**The Ship's Log, 11-1/2"x8-5/8"**

The Ship's log has a flexible, diary type format consisting of lined pages for recording ship's data and activities. Also included are Guest Register, Vessel Specifications and Serial Number List pages as well as quick reference pages on topics including: rules of the road, weather reference, radio procedures and other.

Code | 93981

**The Cruising Log**

The Cruising Log provides ample space for recording information about nautical excursions, as well as, a guest registry. Quick reference pages are provided on such topics as: rules of the road, radio procedures, distress signals and weather reference. It also includes space for you to record vital information about your vessel.

Code | 94013

**The Maintenance Log, 11-1/2"x8-5/8"**

Featuring a detailed format, the Maintenance Log has ample space to list vessel specifications, spare part numbers, previous repairs and maintenance, as well as, space for reference drawings. Also includes quick reference pages on safety, weather, BIA certification requirements and other.

Code | 93983



Navigator's  
Log Book

Code | 99854



Refills for Log  
Book

Code | 99855





# Plumbing & Ventilation



Submersible Bilge Pumps	271-272	Marine Toilets & Accessories	290-293
Float Switches	272-273	Water & Waste Hoses	293-294
Submersible Bilge Pump Switches	273	Hose Clamps	294
Diaphragm Bilge Pumps	274	Brass Fittings	295-296
General Use Pumps	274-278	Thru-Hulls	297-303
Waste Pumps	278	Thru-Hull Accessories	304-305
Freshwater Pumps	278	Drain Plugs	305-306
Showers & Accessories	279-281	Ball Valves	306-307
Faucets & Accessories	282-284	Ventillation	307-312
Water & Waste Tanks	284-290	Strainers	312

Plumbing is also an important part of the boat's equipment. Most boats (open, cabin, inflatable, powerboats, sailboats, etc.) have various plumbing installations, from simple (e.g. deck shower) to really complex ones.

At MARINA Stores, you can find top-quality products by the Italian manufacturer Nuova Rade, such as water tanks, pressurised pumps, toilets, pipes, drains and more.





## Submersible Bilge Pump

The 12 & 24 V Submersible Bilge Pumps are made of shock resistant ABS and powered by the world's best compact motor. The snap-on strainer base makes the installation a simple procedure. These reliable pumps are available in six sizes from 500GPH to 1000GPH.

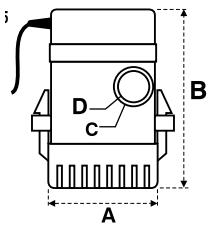

Code	30670	30671	30674	30672	30673	30675
GPH	500	600	600	700	1000	1000
Volts	12	24	24	12	24	24
Fuse (A)	2	5	2	8	10	4
A(mm)	60	60	60	70	70	70
B(mm)	90	90	90	105	105	105
C(mm)	20	20	20	25	30	30
D(mm)	15	15	15	20	25	25

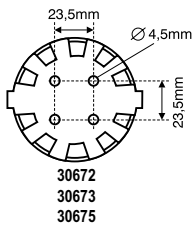

30672  
30673  
30675

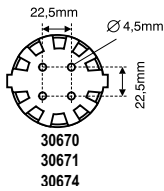

30670  
30671  
30674

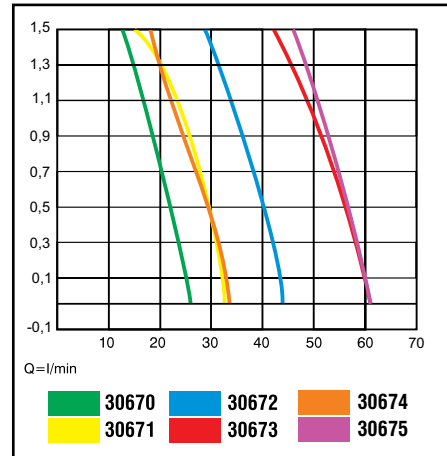
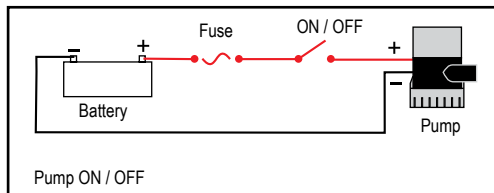
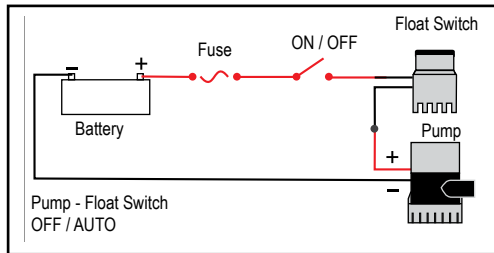

Plumbing & Ventilation



## Submersible Bilge Pump

The best plumbing equipment for hassle-free boating.

### Features:

- Strong and reliable motor
- 100% true efficiency in gallons' value
- Easy to disassemble for installation and cleaning

Code	Gallons (GPH)	Volts (DC)	Fuse (A)	Hose Outlet
72563	1500	12	10	1"
72564	1500	24	5	1"
72565	2000	12	10	1"
72566	2000	24	5	1"

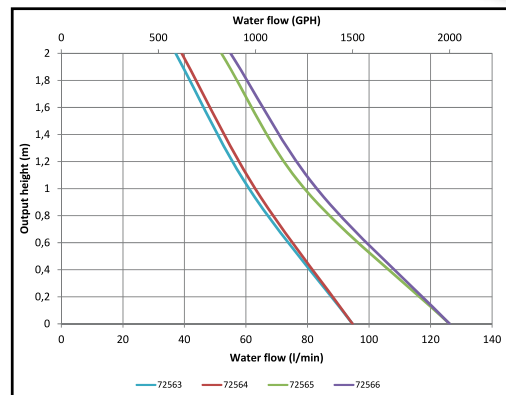
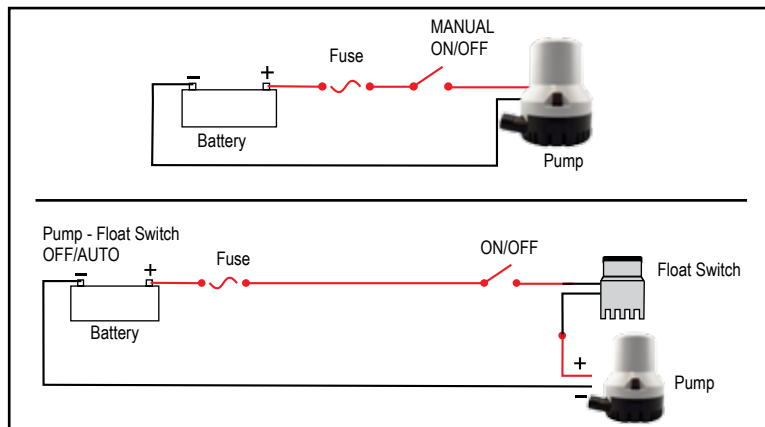
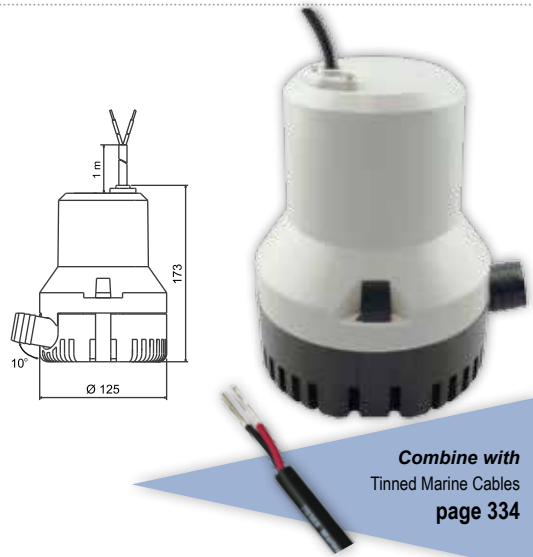

# Submersible Bilge Pumps

## Submersible Automatic Bilge Pump



Nuova Rade Submersible Automatic Bilge Pump combines quality and ease of use in one device. It features very simple disassembly for both installation and cleaning. It has a built-in automatic float switch which activates the pump when the bilge water rises, thereby allowing the pump to operate even when the boat is unattended. The pump also features a manual test button that allows you to test the level switch as well as the pump. Additionally, it has a snap on strainer base making installation and maintenance simple. It is made of durable ASA. The pumping capacity is 600GPH through a 19mm (3/4") hose & 1000GPH through a 25mm (1") hose. Fuse 3A, 4A & 7,5A. 12V & 24V DC. CE. With strong and reliable motor and 100% true efficiency in gallons' value. With 2 years' warranty.

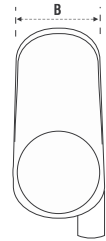
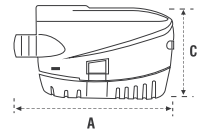

Code	31150	73720	73721	73722
GPH	600		1000	
Volts	12	24	12	24
Fuse (A)	4	3	7,5	4
A(mm)	145	145	151	151
B(mm)	82	82	83	83
C(mm)	90	90	97	97

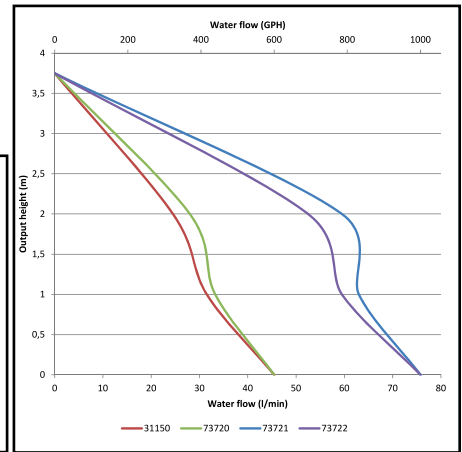

Plumbing & Ventilation

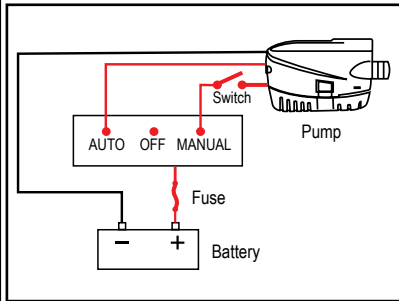
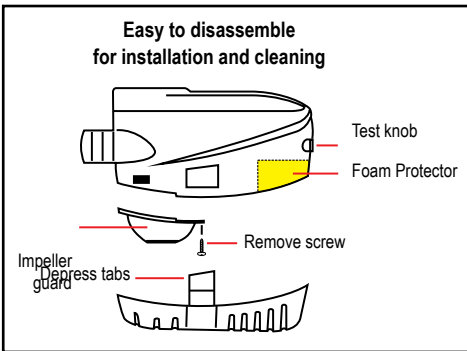

## Electric Gear Pump, 400GPH



Self-priming. Bronze gear pumping elements inside. Pump for transferring the diesel, salt water and any liquid except for flammable liquids with a flash below 37°C (98°F). Flow rate 400 GPH.

Code	Voltage (V)	Intensity (A)	Fuse (A)	Hose Ø
94528	12	15	35	5/8" (16mm)
94529	24	8	15	5/8" (16mm)

## Float Switches

### Float Switch FS-40

Nuova Rade Float Switch FS-40 has been designed to be used with bilge pumps rated up to 10A. The FS-40 activates or deactivates the bilge pump, depending on the water level. Namely, when the water level rises, it forces the float upwards, which switches on the bilge pump. By installing the float switch there is no need to monitor the water level and switch the pump on or off manually. A very important feature is that you can test the smooth operation of the switch at any time, just by operating the test button. The Float Switch FS-40 is made of tough ABS for long life Voltage: 12V/24V DC.



Code | 31170

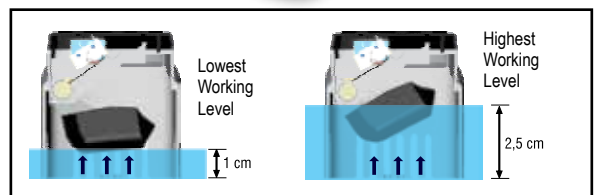
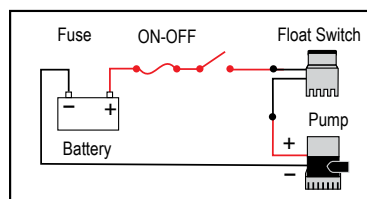
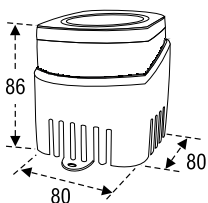

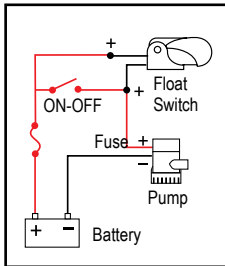

## Automatic Float Switch

This float switch is designed for the automatic control of electrically driven bilge pumps. Designed with a reliable rolling-ball and switch system that prevents rapid on/off cycling found on some switches and is safer than mercury switches. When water lifts the chamber buoy up to 6cm, the switch automatically turns the bilge pump on until the bilge pump is emptied. This automatic float switch has a plastic housing.

Code	Power (V)	Fuse (A)	Material	Length (cm)	Width (cm)	Height (cm)	Amp
91549	12 / 24	15 max	ABS	11	7	6,5	7



**Combine with**  
Tinned Marine Cables  
page 334

## Environmental Electronic Level Switch E.E.L.S

The Environmental Electronic Level Switch is the latest innovation, as it operates with an electronic sensor, instead of the air pressure or any moving parts. It has been designed to sense the water level with great precision and accuracy, thus offering you the best possible result. One of the most important advantages of the E.E.L.S is that it is environmentally friendly. Nuova Rade designed this switch to operate only when it senses water. If there are quantities of hydrocarbons, such as oil, it switches the bilge pump off, thus preventing any pollution. Vertically mounted to the hull, the E.E.L.S is connected in line with bilge pump(s) even of higher potency. Also its compact design allows a far greater freedom of movement. Other features are the insulated electrical contacts, casing from durable Nylon and ABS, 100% impermeability to water.

### Technical characteristics:

The Electronic Level Switch can be used with any bilge pump up to 22A. The Electronic Level Switch has the following electrical characteristics:

**Voltage:** 12V DC

**Connection to the main circuit:** Inline Maximum Intensity: 22A.

### How to connect the Electronic Level Switch

Connect a switch for the activation of the automatic operation of the bilge pump inline to the positive pole of the battery. You should also connect a fuse inline, according to the intensity of the bilge pump and up to 22A max (See manufacturer's instructions). The wires of the Electronic Level Switch which are connected to the poles of the battery are RED (+) and BLACK (-). The other pair of wires, the BLACK (-) and BLUE (+), are connected to the negative and positive pole of the bilge pump respectively.

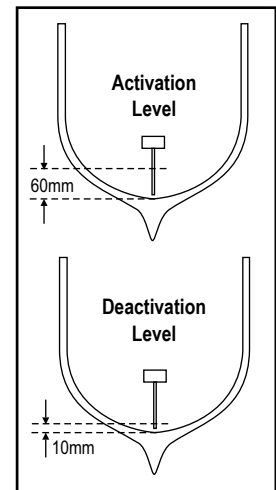

EASY MOUNTING



Code | 31010

### ATTENTION!

It is necessary that you follow the polarity when making the connections, otherwise you run the risk of producing a short circuit, leading to damage your Electronic Level Switch circuit. Please check the polarity before activating your new Float Switch.

### WIRING

Black - Negative (-)

Red - Blue - Positive (+)

Black - Red: Connection to the battery

Black - Blue: Connection to the Bilge Pump

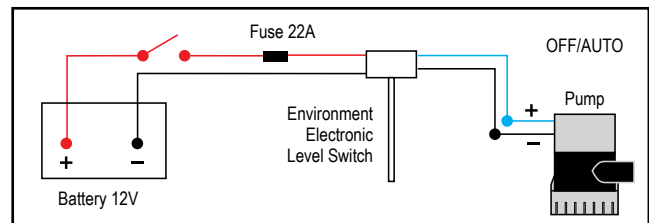

Plumbing & Ventilation

## Submersible Bilge Pump Switches

### Pump Switch

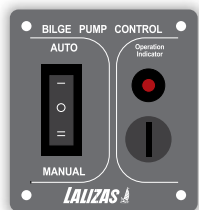

The LALIZAS Pump Switch allows you to operate your boat's bilge pump automatically, manually or even switch it off. It has indication light so that you know when the device is operating. Made of Inox 316 for durability and lifetime protection against corrosion. It is available in charcoal colour.

### Additional features

- Auto-Off-Manual switch
- For use only in 12/24V.
- Max. load per switch: 15A
- Coated with electrostatic paint
- Completely wired and ready to install
- 2 year warranty

INOX 316

2 YEARS GUARANTEE

Code	Switch	Dimensions (cm)		Colour	Voltage (V)
		Height	Width		
31301	Auto-Off-Manual	7	6,5	Charcoal	12-24



### Pump Safety Protector (Off / Manual / Auto)

Code	90182
Voltage (V)	12

**Combine with**  
Tinned Marine Cables  
page 334

# Diaphragm Bilge Pumps

## Diaphragm Bilge Hand Pump

Ideal for use where battery power is not available or as a backup to the electric pumps, the Diaphragm Bilge Hand Pump is easy-to-use and has a capacity of 0,4lt/0,1gallon per stroke. It features a built-in non-return valve, which can be easily removed with the quick release clip and two-position handle for convenient use, depending on your requirements. Additionally, its outlet connection allows the use of either a Ø 3/4" or a 1" hose.



Code | 31342

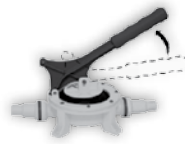

A. Horizontal Position



B. Vertical Position



### Service Kit for Diaphragm Bilge Hand Pump 31342

Includes diaphragm, flapper valves, gasket

Code | 31399



Code	91553	91556
Description	Diaphragm Foot Pump, 4GPM	Diaphragm Repair Kit for Foot Pump 91553



### Hand Suction Pump

Made of anti-corrosion plastic material. Supplied with an adapter for flooring and with 80cm of plastic hose. Comes in 2 different capacities and packaged in single plastic bag, with instructions for use.

Code	90599	90600
Height (cm)	45	60
Each Pumping (cl)	30	50

Plumbing & Ventilation

## General Use Pumps

### Pump Diaphragm

- Max. discharge height: 4m



Code	Volt (V)	Flow Rate (lt/min)	Length (mm)	Height (mm)	Width (mm)
196861	24	19	300	130	160
196862	12				



### Water Pumps

- Self-priming
- Thermal overload, automatic restart
- Runs dry without damage
- Duty cycle: Intermittent



Code	Volt (V)	Max Flow (L/min)	Rated Current (A)	Max Pressure (psi)	Max Draw (A)	Length (mm)	Width (mm)	Height (mm)	Weight (kg)	Hose Outlet (mm)
198069	12	3,8 L/min	2,5	80	4	175	99	64	0,6	Ø10,5

Code	Volt (V)	Max Flow (L/min)	Rated Current (A)	Max Pressure (psi)	Max Draw (A)	Length (mm)	Width (mm)	Height (mm)	Weight (kg)	Hose Outlet (mm)
198070	12	17	6,5	40	11,5	250	107	98	2,54	Ø19,8
198071	24	17	3,5	40	5,5	250	107	98	2,54	Ø19,8





Κωδικός	Volt (V)	Max Flow (L/min)	Rated Current (A)	Max Pressure (psi)	Max Draw (A)	Length (mm)	Width (mm)	Height (mm)	Weight (kg)	Hose Outlet (mm)
56082	12	8	2,9	25	4,5	210	110	120	1,71	Ø13,8



Κωδικός	Volt (V)	Max Flow (L/min)	Rated Current (A)	Max Pressure (psi)	Max Draw (A)	Length (mm)	Width (mm)	Height (mm)	Weight (kg)	Hose Outlet (mm)
53432	12	12,5	4,5	40	8,5	210	108	98	2,2	Ø13,8



Code | 198117

Filter and Connectors for Nuova Rade Pumps 198070-1, Set



Code | 198118

Filter and Connectors for Nuova Rade Pumps 56082,53432, Set

Pressure Switch - max 40psi for Nuova Rade Pumps 53432,198070,198071

Code | 198082



Pressure Switch - max 80psi for Nuova Rade Pump 198069

Code | 198083



Pressure Switch - max 25psi for Nuova Rade Pump 56082

Code | 198081

Plumbing & Ventilation



Bronze Gear Pump Suitable for Diesel

Self-priming electric pump of small dimensions with bronze gears, guaranteeing constant pressure and less noise. Can operate in absence of liquid. Main applications: transfer of diesel fuels and antifreezes.

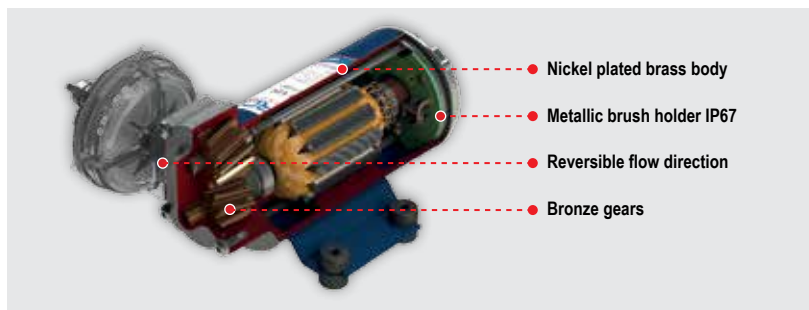

Code	Volt	Amp	Lt/min	Ports (BSPP)	Tube (mm)	Weight (kg)	Pressure (bar)	Dimensions (mm)
97926	12	6	15	3/8"	13	1,4	2	159x166x101
97928	12	10	26	1/2"	16	3,2	2	201x174x111
97927	24	7,5						

**new**

## Bronze Gear Pump Suitable for Diesel & Oil

Heavy-duty electronic gear pump 10 l/min and 3,5 bar. With integrated smart keypad to reverse the flow direction and to manually fine tune the flow rate; the flow rate is also automatically adjusted according to the viscosity of the fluid to avoid cavitation. It is the ideal one for transferring oil and diesel. Compact and easy to operate and carry.

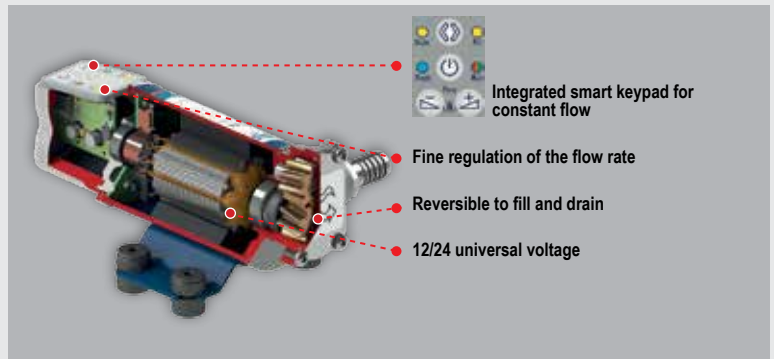

Volt	Amp	Lt/min	Ports (BSPP)	Tube (mm)	Weight (kg)	Pressure (bar)	Dimensions (mm)
12/24	4/2	10	3/8"	13	2,2	3,5	185x114x89

Plumbing & Ventilation



### Tube Kit of 8mm & 6mm ext. diam. for Pumps 99150, 99151

Code | 99156



## Bronze Gears Pump Suitable for Oil

Complete range of self-priming electric pumps with bronze gears to transfer lubricating oil and viscous liquids. The bronze gears guarantee constant pressure and less noise. Can operate in absence of liquid. By using the special tube kit (code 99156), supplied separately, the pump can be employed for draining exhausted lubricants oil out of engines' sumps, particularly marine engines. Operation is done through the dip stick tube. Available in versions with integrated on/off & flow reversing switch or kit with battery clips and hoses.



Code	Volt	Amp.	Flow Rate (oil SAE 20 at 200)			Ports (BSPP)	Tube (mm)	Weight (kg)	Pressure (bar)	Dimensions (mm)
			Ø 6mm	Ø 8mm	Ø 14mm					
99150	12	5	20l/h	60l/h	330l/h	3/8"	13	1,4	2	135x99x88
99151	24	3								



Code	Volt	Amp.	Flow Rate (oil SAE 20 at 200)			Ports (BSPP)	Tube (mm)	Weight (kg)	Pressure (bar)	Dimensions (mm)
			Ø 6mm	Ø 8mm	Ø 14mm					
71738	12	5	18l/h	60l/h	330l/h	3/8"	13	1,8	24	177x108x88

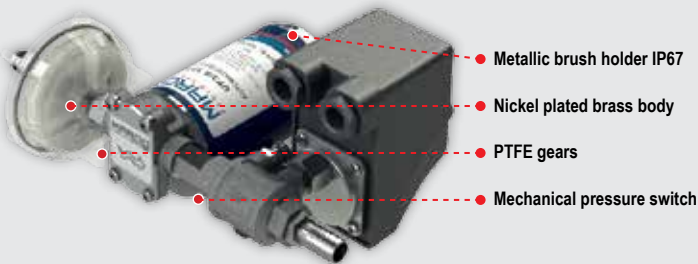

## Automatic Pressure Pump Suitable for Fresh & Salt Water

Self-priming electric pumps with PTFE helical gears, equipped with in-line filter, pressure switch, check valve to be used as automatic pumps for water pressure systems on boats, mobile homes etc.

**Combine with**  
Tinned Marine Cables  
page 334



Code	Volt	Amp	Lt/min	Ports (BSPP)	Tube (mm)	Weight (kg)	Pressure (bar)	Dimensions (mm)
97929	12	6	15	3/8"	13	2,3	2	173x249x118
97930	24	3						
97931	12	8	26	1/2"	16	4	2	201x261x118
97932	24	4						

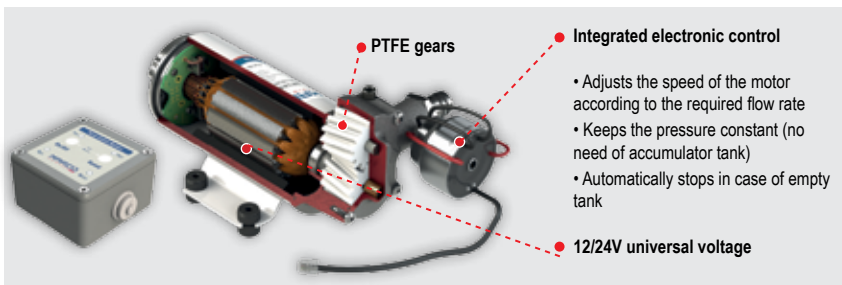

**Electronic Pressure Pump Suitable for Fresh & Salt Water**

Self-priming automatic electric pump with helical PTFE gears, integrated check valve and electronic control. Nickel-plated brass body and stainless steel shaft. Main applications: fresh water pressure systems and shower kits on boats, rubber dinghies, sailing boats and campers.



Code	Volt	Amp	Lt/min	Ports (BSP)	Tube (mm)	Weight (kg)	Pressure (bar)	Dimensions (mm)
90018	12/24	3/1,5	10	3/8"	12	1,3	2	164x116x81
71737	12/24	14/7	36	1/2"	16	4,9	2,5	242x212x113

**Impeller Pump Suitable for Fresh & Salt Water**

Self-priming electric pump with rubber impeller. Ideal for bilge and waste water on any type of boat.



Code	Volt	Amp	Lt/min	Ports (BSP)	Tube (mm)	Weight (kg)	Pressure (bar)	Dimensions (mm)
71736	12	8	28	3/8"	20	1,8	1	152x95x82
97924	12	14	45	3/4"	25	4,1	1,5 bar	194x120x98
97925	24	7						

Plumbing & Ventilation



**Impeller for MARCO Pump**  
 97924, 97925, 94560, 94561, 94562, 94563  
 22,1x50,8 mm / bore 8,07mm



Code | 97900

**Combine with**  
 Tinned Marine Cables  
 page 334



Code	Voltage (V)	Intensity (A)	Diameter (mm)
94560	12	8	26,4
94561	24	10	



**Water Pump, 280GPH**

Code | 90167



**Water Accumulator, Plastic, L 24cm, 1-1,5L**

## General Use Pumps



### Hose Pump, Manual Suction, Transparent

This corrugated hose pump is great to outfit your boat for optimum customisation and maintenance. Allows quick and safe transfer of liquids from one container to another. High-quality and durable PVC material. Suitable for petrol, diesel, water.

Code	Diameter (mm)	Length (cm)	Hose	Hose Thickness (mm)	Flow Rate (gallons/min.)
70002	12,5	160	PVC	2	3,5
70003	22,5			3	10

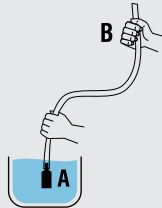

1. Place the bottom end A of the hosepipe into the tank with the liquid that you wish to pump out and hold the top end B of the hosepipe upright

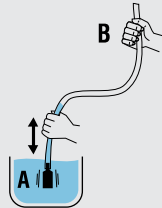

2. Shake the bottom end of the hose vigorously up and down until the liquid rises in the hose, continue pumping until the liquid passes balance level

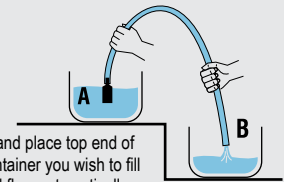

**ATTENTION:** Make sure that the empty container is placed below the level of the container you wish to empty

3. Stop pumping and place top end of the hose in the container you wish to fill and the liquid will flow automatically

## Waste Pumps

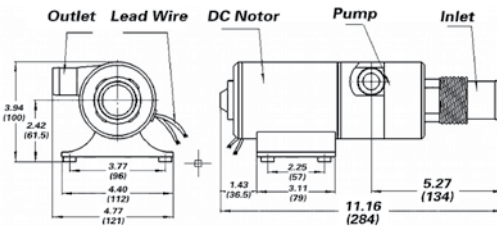

### Waste Pump with Macerator, 700 Gph

**Features:**

- Self-priming
- Runs dry without damage
- Thermal overload, automatic restart
- Duty cycle: Intermittent

Code	Volt (V)	Max Flow (L/min)	Rated Current (A)	Power (W)	Length (mm)	Width (mm)	Height (mm)	Weight (kg)
94562	12	45	12	144	284	121	100	2,11
94563	24		6					

## Freshwater Pumps



**Water In-line Pump, 280GPH, 12V, 3A**

Code | 71159

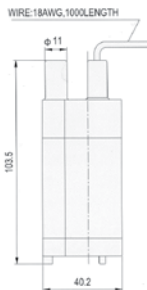

**Water Pump for Tanks 100GPH, 12V, 2A**

Code | 99812

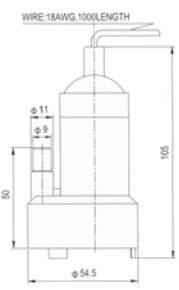

**Water Pump for Tanks 160GPH, 12V, 2,5A**

Code | 99813





**Shower Head with Hose**

With a shower head made of ABS and a PVC hose. It is available in white colour. Having easy installation, Nuova Rade Shower Head with Hose is intended for flush mount installation on the deck or as transom shower.



Code	Hose (m)
55913	3
55914	5

**Shower Hose Braid 1-2"- 3-8"**

Made of PVC material and available in two different dimensions.



Code	Hose (m)
45599	3
196086	5



**Shower Head, Short**

-1/2" threaded shower head with trigger  
- Made of ABS

Code	Colour
196481	Chrome
45598	White



**Shower Head, Long**

-1/2" threaded shower head with trigger  
- Made of ABS

Code	Colour
196480	Chrome
47083	White



**Shower Head, Long**

- With 1/2" thread  
- Made of brass

Code	198041



54601



54604

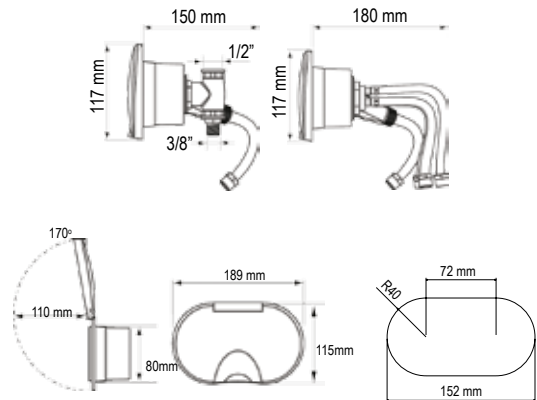

Cut out piece

**Cases with Shower & Water Tap with Lid**

Specifically designed to combine two functions in one single device, they allow major room saving and easy access. In addition to their simplified installation process, they have been engineered to combine optimum comfort, durability and absolute safety. Available with white or chrome cover, the housing fits in any deck or transom to give the boat a clean uncluttered look. Supplied with drilling template.

Code	Water Tap	Connector	Shower Head	Hose (m)	Cover Colour
54601	Cold	"T"	White	3	White
54604	Mixer	20cm 3-hose	White		
54605	Mixer	20cm 3-hose	White	3	Chrome
54606	Mixer	20cm 3-hose	Chrome		

**Case Twin for Shower & Water Tap, with Lid**



Code	Cover Colour
55800	White
196686	Cream
55801	Chrome

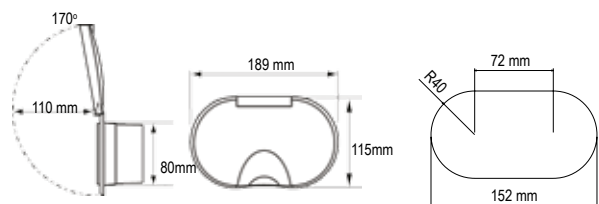

Cut out piece





**Case, Side mounted, with Shower**

Made of ASA, ABS head shower, PVC hose and chrome plated metal parts. Available in white and cream colour with easy installation.  
\*Codes 196469 and 196470 contain Mixer Tap

Code	Water Tap	Lid	Hose (m)	Lid Colour
196469	Mixer	Yes	3	White
196470	Mixer	Yes	5	
44297	No	No	3	
44298		No	5	
196421		Yes	3	
196422		Yes	5	
50015	No	No	5	Cream

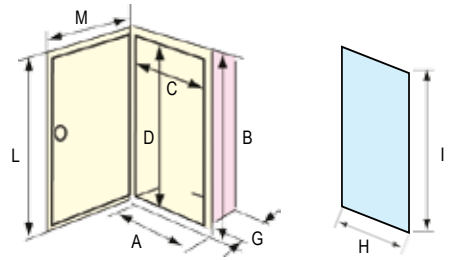

A (mm)	B (mm)	C (mm)	D (mm)	G (mm)	H (mm)	I (mm)	L (mm)	M (mm)
164	237	110	183	95	114	187	247	186

Plumbing & Ventilation



**Case with Shower & Mixer Tap, with Lid with Gasket**

Made of ASA, EPDM gasket, ABS head shower, PVC hose and chrome plated metal parts. Available in white and cream colour. With easy installation, intended for both cold and hot water.

Code	Hose (m)	Colour
196409	3	White
196410	5	
196411	3	Cream
196412	5	

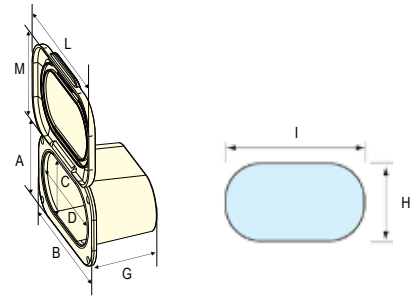

A (mm)	B (mm)	C (mm)	D (mm)	G (mm)	H (mm)	I (mm)	L (mm)	M (mm)
99	170	75	144,5	73,5	75	145,5	177,5	111,5

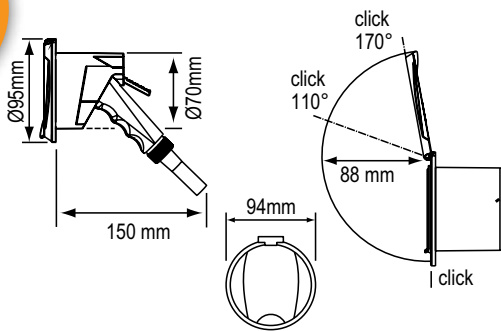

**Case with Shower Spray and Lid**

Made of ASA plastic, ABS head shower and PVC hose. They are available in white and chrome colour. Having easy installation, Nuova Rade Cases with Shower Spray and Lid, include also a 3m hose.

Code	Shower Head	Hose (m)	Lid Colour
46303	White	3	White
46304	Chrome	3	Chrome



**Case for Shower Head, with Round Lid**



Code	Lid Colour
42575	White
46170	Chrome

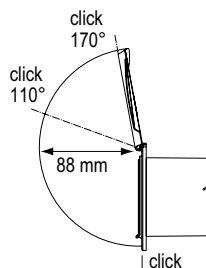

**Case for Shower Head, with Square Lid**



Code	Lid Colour
196399	White
196401	Cream

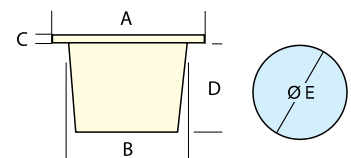

A (mm)	B (mm)	C (mm)	D (mm)	E (mm)
95	75	9	75	75



**Case for Shower Head, Round, with Lid, White**

Code | 35791

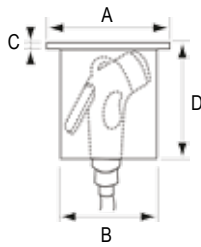

A (mm)	B (mm)	C (mm)	D (mm)
88	66	5	80



**Case for Shower Head, Square, with Lid, White**

Code | 37214

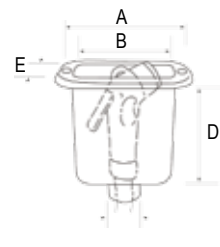

A (mm)	B (mm)	C (mm)	D (mm)	E (mm)
125	87	30	97	90



**Case for Shower**

It is made of PA material. With easy installation and available in white colour.

Code	Colour
44301	White

A (mm)	B (mm)	C (mm)	D (mm)	G (mm)	H (mm)	I (mm)
145	191	110	155	80	115	155

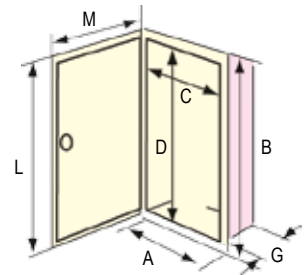

**Case for Shower with Lid**

The body of the product is made of PA and the lid is made of ASA. With easy installation and available in white colour.

Code	Colour
196420	White
196471	

	A (mm)	B (mm)	C (mm)	D (mm)	G (mm)	H (mm)	I (mm)	L (mm)	M (mm)
196420	145	191	105	150	80	115	155	200	165
196471	165	237	110	183	95	114	187	247	186

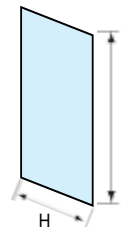

Plumbing & Ventilation



Code | 31349

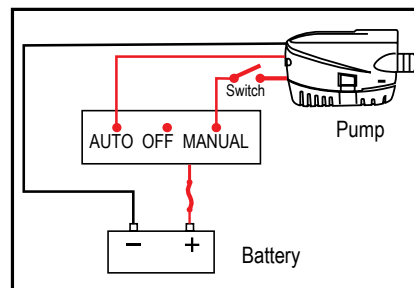

**Shower Sump System LSU 600, 12V**

Designed especially for use on boats with built-in sink, shower or tub, the LSU 600 will pump all water out of the drain and into the tank. It is compact and can be mounted either against the floor or against the walls, in which case the two legs can be cut off. It has a built-in automatic bilge pump that will start operating, as soon as the float switch senses water. Additionally, it features a filter, which can be easily serviced by removing the top transparent cover and a non-return valve at the outlet hose. The LSU 600 case is made of resistant polypropylene and the lid of acrylic. Its power consumption is limited to 2,5A at 12V, fuse 4A. The LSU 600 System has 3 inlet hoses (2 of 19,1mm (3/4") and 1 of 25,4mm (1")) and 1 outlet hose with non-return valve for hose of 19,1mm (3/4") and 25,4mm (1") in diameter.



### Case with Water Inlet/Outlet, with Lid

Made of ASA and chrome plated metal parts. They have sea water outlet and fresh water inlet. Having easy installation, Nuova Rade cases are available in white colour with white or chrome lid. You can also choose between straight or elbow connector. Sea water outlet/Fresh water inlet with quick connectors.

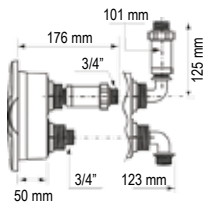

Code	Connector	Lid Colour
54611	Straight	White
54612	Straight	Chrome
54613	Elbow	White

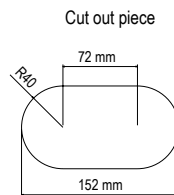
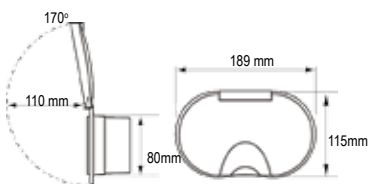

### Case with Cold Water Tap & Outlet, with Lid

Made of ASA and chrome plated metal parts. Having easy installation, Nuova Rade Cases are available in white colour, with chrome or white lid. You can also choose between straight or elbow connector.

The cases include:

- Sea water outlet with quick female connector
- Cold water tap + "T" connector
- Stainless steel threaded hose

Code	Connector	Lid Colour
54607	Straight	White
54609	Elbow	White
54610	Elbow	Chrome

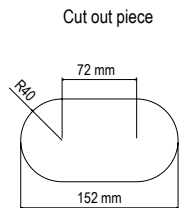
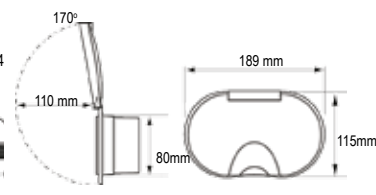
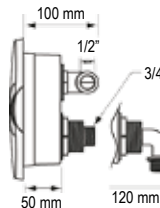

### Case with Cold Water Tap, with Lid

Made of ASA and chrome plated metal parts. They are available in white and cream case colour. Having easy installation, Nuova Rade Cases with Cold Water Tap with Lid are intended only for cold water.



Code	Case Colour
196393	White
196397	Cream

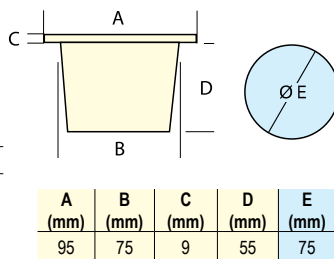

### Case with Mixer Tap (Cold/Hot), with Lid

Made of ASA and chrome plated metal parts, they are available in white and cream case colour. Having easy installation, Nuova Rade Cases with Mixer Tap with Lid are intended for both cold and hot water.



Code	Case Colour
196392	White
196396	Cream

### Case with Mixer Tap (Cold/Hot), with Lid

It features a chromed brass mixer tap and 3-hose connectors of 20cm. Available with chrome or white lid and intended for both cold and hot water.

Code	Water Tap	Connector	Lid Colour
46206	Mixer	20 cm 3-hose connectors	Chrome
47676	Mixer	20 cm 3-hose connectors	White

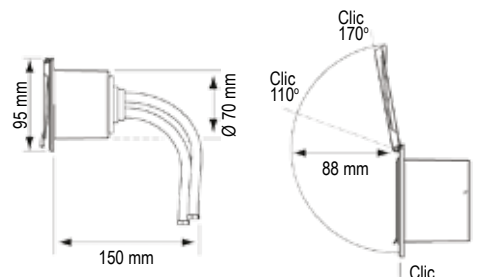



Code | 45601

**Mixer Water Tap (Cold/Hot)**

Made of chrome plated brass. It features 3-hose connectors of 20cm. Mixer Water Tap is intended for both cold and hot water.



Code | 99960

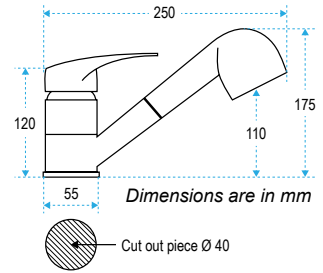

**Faucet, with Adjustable Spray & Shower Tube 150cm**

**Case for Water Tap, with Lid, Round**

It is suitable for mixer tap and water tap and it is available with lid in white or chrome colour.



Code	Lid Colour
42576	White
46171	Chrome

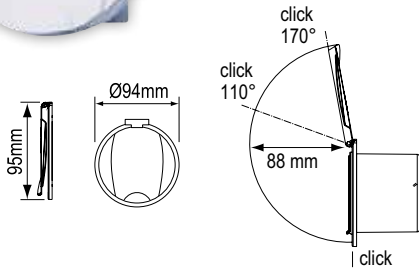

**Case for Water Tap with Lid, Square**

It is suitable for mixer tap and includes a gasket. Available in white and cream colour.

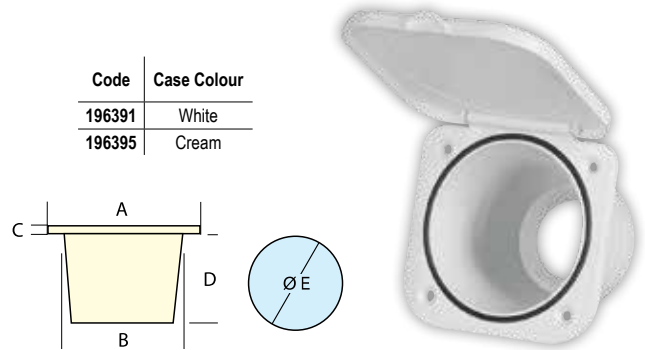

Code	Case Colour
196391	White
196395	Cream

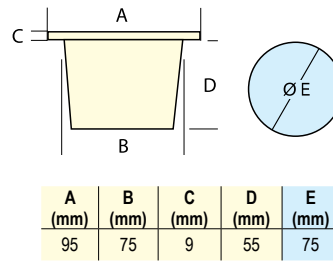

A (mm)	B (mm)	C (mm)	D (mm)	E (mm)
95	75	9	55	75

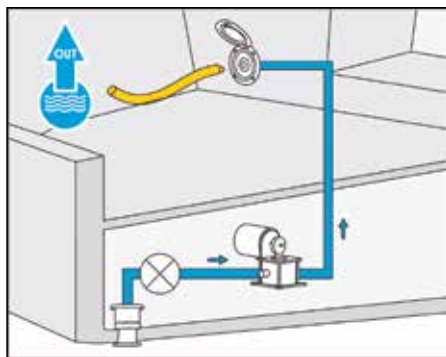

**Case with Sea Water Outlet, with Lid**

Used in conjunction with a pump and thru-hull fitting, the Sea Water Outlet produces pressure sea water on the deck (to wash the deck or rinse the fish). Also perfectly suitable for fresh water.

**The complete set includes:**

- An ASA housing with splash-proof ASA cover
- A female quick-coupling fitting for garden hose connection. Features a non-return valve
- Chrome brass quick coupling connectors for optimum corrosion resistance
- A locking flange
- Male 3/4" threaded connector to the boat's water system

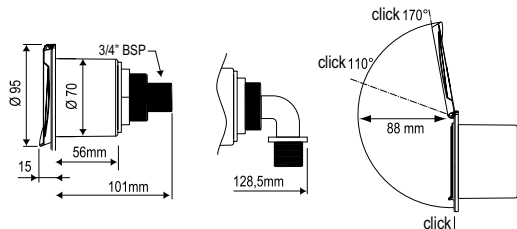

Code	Terminal	Lid Colour
47816	Straight	White
47817	Elbow	
47818	Straight	Chrome
47819	Elbow	



Plumbing & Ventilation



## Case with Fresh Water Inlet, with Lid

This is the perfect connection between the boat's water network and the shore water supply. It is then easy to cook or have a shower when at the dock, without using water from the tanks (Not suitable for filling the water tanks).

### The complete set (47812-5) includes:

- An ASA housing with plastic splash-proof cover
- A pressure regulator which accepts up to 5 bar working pressure, compatible with most appliances and equipment on board
- A non-return valve
- A male quick-coupling fitting for garden hose connection
- Male 3/4" threaded connector to the boat's water system

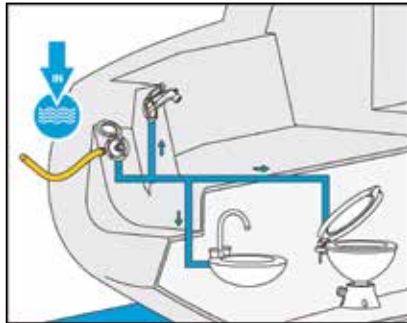

### The complete set (58131) includes:

- An ASA housing with plastic splash-proof cover
- A male quick-coupling fitting for garden hose connection
- Male 3/4" threaded connector to the boat's water system
- Metal pressure regulator with cloth diaphragm valve, adjustable from 1,5 to 5 bar
- Maintenance free, robust construction with silent operation (no vibration)
- Max. inlet pressure: 15 bar
- Max. temperature: 70°C
- Corrosion preventing DZR brass body
- Factory preset (4 bar at zero discharge for 3 bar working)
- Diaphragm and seals EPDM & NBR
- Slotted adjusting screw that can be turned with a flathead screwdriver
- Female 1/4" pressure gauge outlet

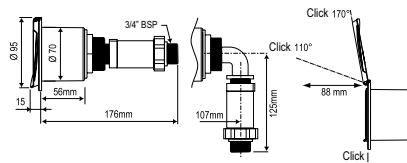

Code	Connector	Lid Colour	Pressure Regulator
47812	Straight	White	Plastic up to 5 Bar
47813	Elbow		
47814	Straight	Chrome	
47815	Elbow		
58131	Elbow	White	

Plumbing & Ventilation



**Galley Pump with Tap, 12V**

Code | 98096



**Spare Electric Galley Pump for Tap 98096, 12V**

Code | 71158



Code | 98097

**Hand Galley Pump with Built-in Check Valve, 1GPM**

- Chrome-plated die case top with plastic body
- Uses 3/8" hose
- Capacity: 1GPM
- Self-priming

## Water & Waste Tanks



45361-67



45359-60

### Water Tank

Nuova Rade water tanks are used for saving water in sailboats or yachts. The line of horizontal fresh water tanks is produced from polyethylene material, in white colour. The line consists of a full range of 9 models complying with international standards and is used for water collection and storage. All contain a cap with seal.

Code	Capacity (lt)	L (mm)	W (mm)	H (mm)	G (mm)	A (mm)	B (mm)	C (mm)
45359	30	560	400	140	155	325	140	120
45360	70	580	580	200	220	345	230	120
45361	48	480	400	250	265	180	140	120
45362	59	680	460	190	205	410	170	120
45363	72	680	460	230	245	410	170	120
45364	84	700	400	300	315	290	140	120
45365	85	880	480	200	215	380	180	120
45366	80	650	450	280	295	265	165	120
45367	140	1200	450	260	275	935	165	120

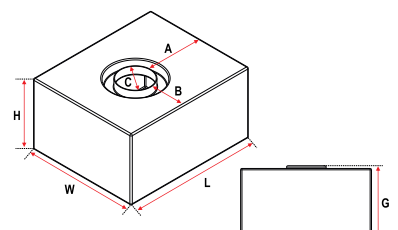



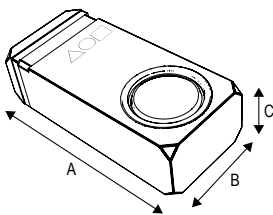

**DIABLO Fixed Tank, for Fresh & Waste Water**

DIABLO line of fixed tanks is made of recyclable HDPE material, consisting of a full range of 10 models complying with international standards. DIABLO can be used for either fresh or waste water. The advantage of this line of tanks is the 'EASY SWITCH' plate, which can be purchased separately based on the use of the tank, and is manually interchangeable. The hatch used for fresh water is blue and the one used for waste water is brown. It is secured and seated by rotation of the piece itself and blocked into position by means of a locking pin that prevents loosening. To clean the tank just lift the locking pin and remove the hatch by unscrewing it.



Code	197477	197478	197479	197480	197481	197482	197483	197484	197485	197486
Capacity (lt)	37	48	60	70	82	49	64	78	93	108
A - Length (mm)	500	650	800	950	1100	500	650	800	950	1100
B - Width (mm)	360	360	360	360	360	360	360	360	360	360
C - Height (mm)	230	230	230	230	230	305	305	305	305	305

	Fresh Water		Waste Water
	Sensor (optional)		
Impedance (Ohm)	0-190	240-33	240-33
 h=230mm	197348 (200mm)	197357 (200mm)	197365 (150mm)
 h=305mm	197350 (300mm)	197359 (300mm)	196911 (233mm)



**Bracket for Battery Box/Fuel Tank, with Strap 1,50m**

Code | 43897



**DIABLO Easy Switch Waste Water Plate**

Waste water hatch with gasket. Complete with:  
 -Connector 90°, Ø38 mm, 1½" thread  
 -Connector 90°, Ø25 mm, 1½" thread  
 -Set of Connectors 90°, Ø25 mm & Ø20mm, 1" thread

Code	197489	197491
For Tank Height (mm)	230	305



**DIABLO Easy Switch Fresh Water Plate**

Fresh water hatch with gasket. Complete with:  
 - Connector 90°, Ø38 mm, 1½" thread  
 - Connector 90°, Ø17 mm, ¾" thread  
 - Connector 90°, Ø13 mm, ¾" thread

Code | 197488



**DIABLO Easy Switch Blind Plate, without Connectors**

With gasket

Code | 197490



197492, 197495, 197498, 197499



197500



197501

Code	Description	197488 Easy switch water	197489 Easy switch waste H230mm	197491 Easy switch waste H305mm
197492	DIABLO Easy Switch Connector 90°, Ø38mm, 1½" thread	1	2	2
197495	DIABLO Easy Switch Connector 90°, Ø17mm, ¾" thread	1	-	-
197498	DIABLO Easy Switch Connector 90°, Ø13mm, ¾" thread	1	-	-
197499	DIABLO Easy Switch Connector 90°, Ø25mm, 1½" thread	-	2	2
197500	DIABLO Easy Switch Set Connector 90° Ø25 & 20mm 1" thread	-	1	1
197501	DIABLO Easy Switch Internal Gasket Ø 235 x 17,5mm	1	1	1



**Ercole**



**ERCOLE Fixed Fresh Water Tank**

ERCOLE line of horizontal fresh water tanks is produced from polyethylene material in white colour. Polyethylene material is used to prevent any taste alteration of fresh water. This line consists of a full range of 9 models complying with international standards and is used for fresh-water collection and storage. All contain a water output for Ø16mm hose and a water supply input that is either threaded with a cap, either with a vertical outlet for Ø38mm hose, either with an 45°-angled outlet for Ø38mm hose. Pre-cut for tank level sensor.

Code	Type	Capacity (lt)	A Length (mm)	B Width (mm)	C Height (mm)	Connector Pipe Ø (mm)	Deck Filler	Sensor (optional)	
								0 - 190 Ohm	240 - 33 Ohm
44798	With filler cap	45	500	350	300	16	Thread Ø 50mm		197358 (250mm)
44800		56	650						
44802		70	800						
50193	Without cap	45	500	350	300	16	Straight Ø 38mm		196911 (233mm)
50197		56	650						
50203		70	800						
50194	Without cap	45	500	350	300	16	45° Ø 38mm		196911 (233mm)
50198		56	650						
50204		70	800						

Plumbing & Ventilation

**Sogliola**

**Combine with**  
Water delivery hose  
page 293



**SOGLIOLA Fixed Fresh Water Tank**

SOGLIOLA line of horizontal fresh water tanks is produced from polyethylene material in white colour. Polyethylene material is used to prevent any taste alteration of fresh water. The line consists of a full range of 9 models complying with international standards and is used for fresh water collection and storage. All contain a water output for Ø16mm hose and a water supply input that is either threaded with a cap, either with a vertical outlet for Ø38mm hose, either with an 45°-angled outlet for Ø38mm hose. Pre-cut for tank level sensor.

Code	Type	Capacity (lt)	A Length (mm)	B Width (mm)	C Height (mm)	Connector Pipe Ø (mm)	Deck Filler	Sensor (optional)	
								0 - 190 Ohm	240 - 33 Ohm
44833	With filler cap	45	650	350	220	16	Thread Ø 50mm		197356 (150mm)
44835		60	800						
44837		80	1100						
50207	Without cap	45	650	350	220	16	Straight Ø 38mm		197365 (150mm)
50212		60	800						
50216		80	1100						
50208	Without cap	45	650	350	220	16	45° Ø 38mm		197365 (150mm)
50213		60	800						
50217		80	1100						





### Ercole - Sogliola

Code	Description
45284	A Tank Filler Cap
44467	C Fuel Pick-up Tube w/Pipe Conn. Ø8mm
50140	D Water Pick-Up Tube w/ Ø16mm Conn
44088	FGHE Set Connectors, w/Ø50mm, Straight
44089	GHI Set Connectors, w/Ø38mm, Straight
43366	E Straight Connector Ø50mm
43368	I Straight Connector Ø38mm
44090	FGHM Set of Connectors, w/Ø50mm, 90° Elbow
44091	GHN Set of Connectors, w/Ø38mm, 90° Elbow
43370	M Elbow Connector 90°, Ø50mm

Code	Description
43374	N Elbow Connector 90°, Ø38mm
44624	F Elbow Conn. 90°, Pipe f/Fuel Return
44569	P Vent. Elbow Conn. 90°, Hose Ø16mm
44838	Q Universal Bracket with Holding Straps for Ercole, Sogliola, Diablo Tanks and Life rafts

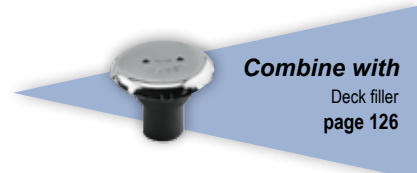

### BORA Fixed Fresh Water Tank

BORA line of horizontal fresh water tanks is made of high-density polyethylene material, in white colour. Polyethylene material is used to prevent any taste alteration of fresh water. The line consists of a full-size range of 40L, 60L, 80L and 100L, complying with international standards and is used for fresh water collection and storage. This fresh water tank is available in two options. One option is provided with only the holding base tank alone and the other option comes with a complete set, that includes a holding tank, a self-priming pump (12V) and fittings. A large range of accessories is available, such as pump, sensor, vented loop, valve, filter and deck filler.

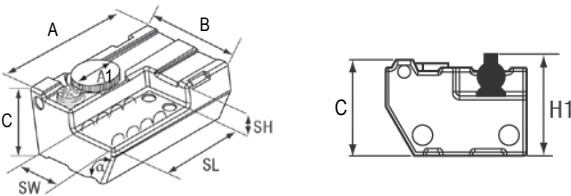

### Bora



Code	Type	Capacity (lt)	A Length (mm)	B Width (mm)	C Height (mm)	H1 (mm)	SL (mm)	SW (mm)	SH (mm)	Hole Ø A1 (mm)	α Angle	Pump	Sensor (Optional)		
196887	Base Tank	40	545	400	270	-	350	200	80	133,5	120°	*	 197348 (200mm)		
196888		60	775	400	270	-	350	200	80	133,5	120°	*			
196889		80	1005	400	270	-	350	200	80	133,5	120°	*			
196890		100	1245	400	270	-	350	200	80	133,5	120°	*			
196895	Tank with Pump	40	545	400	270	300	350	200	80	133,5	120°	 56082 (12 V, 8lt/min)	 197357 (200mm)		
196896		60	775	400	270	300	350	200	80	133,5	120°				
196897		80	1005	400	270	300	350	200	80	133,5	120°				
196898		100	1245	400	270	300	350	200	80	133,5	120°				
197062		60	775	400	270	280	350	200	80	133,5	120°			 53432 (12 V, 12,5lt/min)	 197348 (200mm)
197063		80	1005	400	270	280	350	200	80	133,5	120°				
197064	100	1245	400	270	280	350	200	80	133,5	120°		 196911 (233mm)			

\*Optional Pump 56082 (12V, 8 lt/min)

Plumbing & Ventilation



## Blizzard



### BLIZZARD Fixed Waste Water Tank

BLIZZARD line of horizontal waste water tanks is made of high-density polyethylene material, in brown colour. Polyethylene material is used to prevent any waste odors. The line consists of a full-size range of 40L, 60L, 80L and 100L, complying with international standards and can safely hold waste water from toilets until they can be discarded safely. This waste water tank is available in two options. One option is provided only with the holding base tank alone and the other option comes with a complete set, that includes a holding tank, a diaphragm pump (12V) and fittings. A large range of accessories is available, such as pump, sensor, vented loop, valve, filter and deck filler. Manufactured in accordance with ISO 8099.

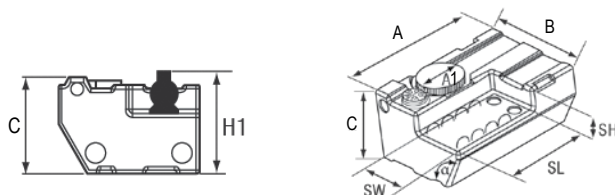

Code	Type	Capacity (lt)	A Length (mm)	B Width (mm)	C Height (mm)	H1 (mm)	SL (mm)	SW (mm)	SH (mm)	Hole Ø A1 (mm)	α Angle	Pump	Sensor
196867	Base Tank	40	545	400	270	-	350	200	80	133,5	120°	*	**
196868		60	775	400	270	-	350	200	80	133,5	120°	*	**
196869		80	1005	400	270	-	350	200	80	133,5	120°	*	**
196870		100	1245	400	270	-	350	200	80	133,5	120°	*	**
196871	Tank with Pump and sensor	40	545	400	270	320	350	200	80	133,5	120°	196862 (12 V, 19 lt/min)	196911 240-33 Ohm
196872		60	775	400	270	320	350	200	80	133,5	120°		
196873		80	1005	400	270	320	350	200	80	133,5	120°		
196874		100	1245	400	270	320	350	200	80	133,5	120°		
196875		40	545	400	270	320	350	200	80	133,5	120°	196861 (24 V, 19 lt/min)	
196876		60	775	400	270	320	350	200	80	133,5	120°		
196877		80	1005	400	270	320	350	200	80	133,5	120°		
196878		100	1245	400	270	320	350	200	80	133,5	120°		

\*Optional Pump 196862 (12V, 19 lt/min) or 196861 (24V, 19 lt/min) \*\* Optional Sensor 196911

## Zefiro

### ZEFIRO Fixed Waste Water Tank

ZEFIRO line of vertical waste water tanks is made of high-density polyethylene material in brown colour. Polyethylene material is used to prevent any waste odors. These tanks are designed with a gravity discharge technology that allows easier unloading of the tank without using a pump, when installation is carried out at more than 0.5 m above the waterline. Can be mounted on a bulkhead of the boat, saving space and time. The line consists of two models with capacity of 40L and 60L, complying with international standards and can safely hold waste water from toilets until they can be discarded safely. All contain 1 inlet and 2 outlets of Ø 38 mm - G 1 1/2" and one vent of Ø 25 mm - G 3/4". They have an inspection hatch of Ø 127 mm, that can be removed for cleaning purposes. Contain a plate compatible with VDO standard senders and are compatible with diaphragm pumps and macerators (12 or 24 V). Manufactured in accordance with ISO 8099.



Code	Capacity (lt)	L1 (mm)	L2 (mm)	W (mm)	H (mm)	H1 (mm)	Hole Ø A (mm)	Sensor (Optional)
196881	40	400	302	250	493,7	540	133,5	196909
196882	60	400	302	250	703,7	750,3	133,5	196910

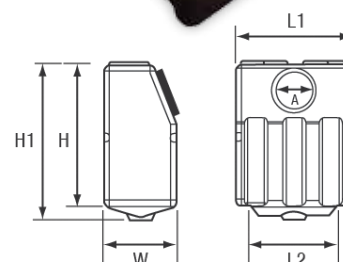



Connectors



Blizzard - Bora - Zefiro

	Code	Description	Model	Ø (mm)		Code	Description	Model	Ø (mm)	
A	196906	Straight	G 3/4"	16	D	196917	Straight	G 1 1/2"	38	
	196904		G 3/4"	20		E*		196902	G 1 1/2"	38
	196915		G 3/4"	25		F		196905	G 3/4"	20
B	196914	Straight	G 1 1/4"	25	G	196916	90°	G 3/4"	25	
	196913		G 1 1/4"	38		F		196918	G 1 1/2"	38
C	196925		G 1 1/2"	25	H*	196901		G 1 1/2"	38	

\*Set of 3pcs

Flexible Water Tank

The flexible, lightweight and form-fitting water tanks are a strong, reliable, practical and low cost solution to store water on your boat when a rigid water tank is not an option. Water tanks are supplied complete, ready to install, with two welded fittings. A Ø 38 mm inlet fitting and a Ø 12 mm outlet valve with moveable thread tightening rings for maximum sealing. The tanks have metal hooks for fixing (hanging) and therefore allow for a better stability. The tanks are made of non-toxic PVC, waterproof and high-resistant material that protects them from tearing and abrasions. Compact design allows for easy storage in your boat, car, truck, RV, garage, or home. Nuova Rade Flexible Water Tanks are available in 6 rectangular sizes as well as in 2 triangular sizes, in grey colour.

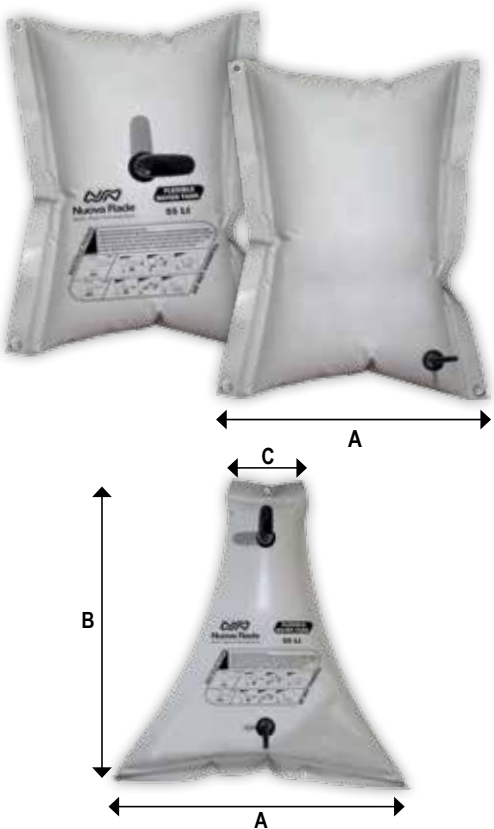

Rectangular

Code	Capacity (lt)	A (mm)	B (mm)	A Filled (mm)	B Filled (mm)	Height Filled (mm)	Outlet Fitting	Inlet Fitting	Cap
31321	55	750	740	700	715	430			
31322	75	840	740	755	690	440			
31323	100	1000	740	910	685	500			
31324	120	1250	740	1155	700	510			
31329	150	1500	740	1380	700	535			
31327	200	1700	740	1600	680	535			

\* included

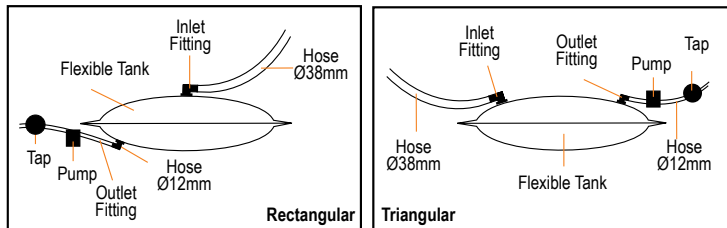

Triangular

Code	Capacity (lt)	A (mm)	B (mm)	C (mm)	A Filled (mm)	B Filled (mm)	Height Filled (mm)	Outlet Fitting	Inlet Fitting	Cap
31325	55	860	930	210	795	800	305			
31326	100	1140	1060	210	1105	1090	420			

\* included



Inlet Elbow Fitting for Ø38mm Hose, 1 1/2" Thread Tightening Ring, Black

Code | 72133



Outlet Elbow Fitting for Ø12mm Hose, 1 1/2" Thread Tightening Ring, Black

Code | 72134



Cap 1 1/2" Thread

Code | 197493



## Water & Waste Tanks



**Water Carrier, Flexible**

Code	99589
Capacity (lt)	20
Length (mm)	270
Width (mm)	270
Height (mm)	270



**Water Shower Tank , flexible**

- It is made of PVC and can heat 20L of water
- It is lightweight & small, saving you a lot of space
- It is environmental friendly, since the construction material does not contain any toxin

Code	99976
Capacity (lt)	20

## Marine Toilets & Accessories

Plumbing & Ventilation



**SEA TOILET Portable Toilet**

The SEA TOILET Portable Toilet is suitable for interior and exterior use. It is self-contained and it does not require any external water or power connections. It consists of two separate tanks: a fresh water holding tank of 12L capacity and a waste holding tank of 10L. However, you can change the waste tank's capacity to 20L, by replacing the 10L waste tank with the 20lt waste tank (11869). The toilet is made of high-density polyethylene (HDP) with matte finish for greater resistance to scratches.

Code | 11867



The fresh water tank provides up to 50 flushes



Heavy duty, corrosion resistant side latches lock the tanks together



The double sealed drain valve protects against leakages and odours



Both waste and fresh water tanks are one-piece construction; no seams required



The detached waste holding tank (10lt or 20lt) can be easily emptied, without using any tools

**Spare Cap for the Fresh Water Tank of the Portable Toilet 11867**



Code | 11871

**Spare Cap for the Waste Holding Tank of the Portable Toilet 11867**



Code | 11872

**Spare Slide Valve for the Spare Tanks 11868 & 11869**



Code | 11873

**Spare Waste Holding Tank for the Portable Toilet 11867**



Code	11868	11869
Capacity (lt)	10	20
Dimensions LxWxH (mm)	415x365x150	415x365x280

**Base for the Portable Toilet 11867, H 125mm**



Code | 11870



**Cleaning Fluid for Portable Toilet, 2L**

Code | 63447



**Manual Marine Toilet LT-0 & LT-1**

The LT-0 and LT-1 Toilets are especially designed for long term use. They are available in two sizes: compact (LT-0) and regular (LT-1). Both can be easily installed above or below the waterline. If they are installed below the waterline, it is necessary to use an anti-siphon loop to prevent water inflow into the interior. Furthermore, these toilets can be installed with the pump either at the right or the left side of the porcelain bowl. The valves have been designed for a longer and more reliable service life. The drain plug has been designed with a quick fit locking mechanism for easier and more effective drainage of the toilets. All parts are made of corrosion resistant materials.

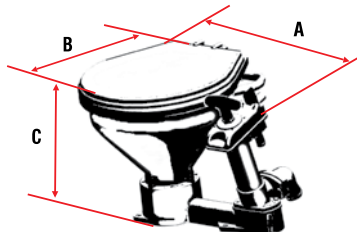

Code	Description	Dimensions (mm)		
		A	B	C
11510	LT-0	450	420	340
11412	LT-1	485	480	340

**Kits for the Marine Manual Toilets**

Code	Description	Key
11451	Kit E, Base to Bowl Mounting Kit	28,31,32,33,34,35,36,37,38
11447	Kit A, Major Service Kit	4,9,10,11,16,17,20,24,29
11535	Assembled Spare Pump	1,2,3,4,5,6,7,8,9,10,11,12,13,14,15,16,17,18,19,20,21,22,23,24,25,26,27,29,30
11452	Cover Set for manual toilet LT-1	40
11519	Cover Set for manual toilet LT-0	40

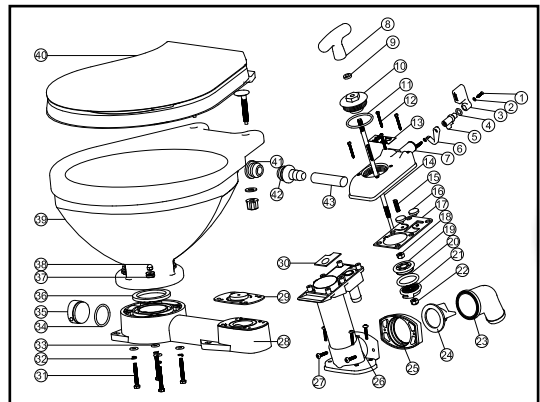

Plumbing & Ventilation



**Electric Marine Toilet LT-0E & LT-1E**

The Electric Toilets LT-0E and LT-1E can be supplied as either 12V or 24V and have been designed to make your life on board easier, because of their self-priming double action pumps. By just pushing the on/off switch, which can be installed anywhere in the toilet cabin, you activate the pump and while fresh water rinses in the bowl, the macerator grinds up and pumps out the waste. The LT Electric Toilets can be easily installed either above or below the waterline. Please note that when they are installed below the waterline, it is necessary to use an anti-siphon loop for preventing water inflow into the interior. Furthermore, the toilets are supplied either with a compact (LT-0E) or a regular bowl (LT-1E). Additionally, the LT toilets have been designed with a quick fit locking mechanism, which allows you to easily remove the pump's base, in order to clean the exposed waste surfaces. All parts are made of corrosion resistant materials.

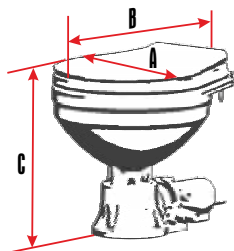

You can install the pump to four different positions, relating to the bowl



Code	Description	Rate Voltage (Volt)	Load Current (Amps)	Dimensions (mm)		
				A	B	C
11874	LT - 0E	12	12-15	325	420	375
11875		24	6-8			
11876	LT - 1E	12	12-15	365	480	385
11877		24	6-8			

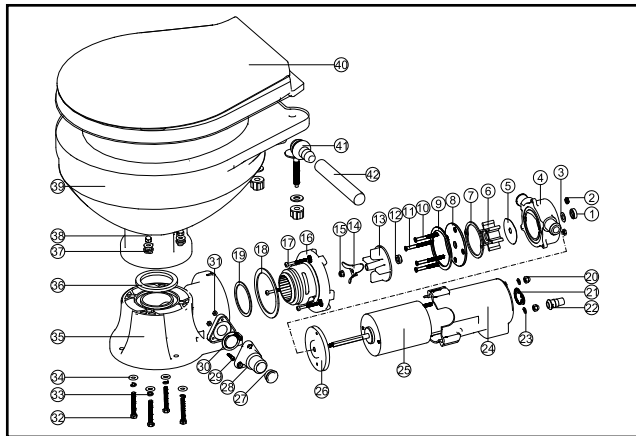

## Kits for the Electric Marine Toilets

Code	Description	Key
11879	Repair Kit for the Electric Toilets 24V	1-36
11878	Repair Kit for the Electric Toilets 12V	1-36
74304	Plastic Base for the Electric Toilets with Spare Parts	27 to 31 & 35 to 36
11519	Cover Set for manual toilet LT-0E	40
11452	Cover Set for manual toilet LT-1E	40

Plumbing & Ventilation



### Repair Kit for the Electric Toilets (12V)

Code | 94541



### Cover Set for LT Toilets

Code	For Toilet		Material
11519	LT-0	LT-0E	MDF
11452	LT-1	LT-1E	PP



### Case for Toilet Paper with Door

High quality Case for Toilet Paper with Door, ideal for every sailboat's or yacht's toilet. Available in dimensions of 160 x 160mm and in white colour, this case can cover the needs of boats of any size. It is made of white ASA plastic in order to provide resistance to damage and chemical solvents. Designed for internal use. It is ideal for storing your toilet paper, using its holder (195258). Contains a 180° opening door. This case is mounted with hidden screws for discrete appearance.

Code | 195263

A (mm)	B (mm)	C (mm)	D (mm)	E (mm)	F (mm)	G (mm)	H (mm)	I (mm)
160	160	118	128	118	167	162	125	135

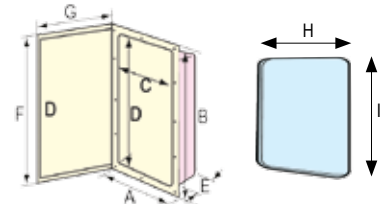

### Holder for Toilet Paper

High quality Holder for Toilet paper, ideal for installation next to your boat's toilet. Made of UV-resistant ASA plastic, it provides resistance to damage and chemical solvents. Available in white colour. To be used combined with the the Case for Toilet Paper with Door (195263).



Code | 195258

### Electric Toilet Flush Switch Mon-Off, 12V/24V



- Rocker switch with Mon-Off function (automatically returns to OFF from flush position)
- Dual (12/24V) voltage rating: DC 12V 20A /24V 10A
- Dimensions: length 114mm, width 54mm
- Mounting dimensions: length 103mm, width 43mm, depth 75mm
- IP66
- Circuit protection: resettable circuit breaker 20A

Code | 73021



### Anti-vent Loop Connection

An anti-vent loop connection is required when the toilet installation is below the waterline. This prevents water inflow into the interior. The anti-vent loop connection is made of ABS and is available in two different sizes.

Code	External Diameter (cm)
90184	1,9
90185	3,8



**Spare Disinfectant Tablets for "DSRU" Marine & Pine (2 Tablets)**

Code | 11866

**Disinfect Sanitizing Release Unit "DSRU"**

The DSRU is a unit that keeps your toilet bowl clean and free from limescale. The unit should be attached to the pipe, where water flows from the flush pump to the toilet. As water is pumped towards the bowl, it sucks a quantity of the disinfectant inhibiting limescale. It also colours the water (green or blue) and deodorizes. Each unit is supplied with two tablets, 'Marine' (blue) and 'Pine' (green) scent respectively. The tablets are also sold separately, but the DSRU is designed to fit any tablet in the market smaller than 30 x 30 x 40mm.

The DSRU is very easy to install, requires minimum maintenance and has a discreet and compact design.



Code | 11865



**Water & Waste Hoses**



Code	Internal Diameter
99485	13mm, 1/2"
99486	16mm, 5/8"
99487	19mm, 3/4"

**Liquid Discharge-Water Delivery Hose PVC, White, Fiber Reinforced**



\* Sold by linear meter

Code	Internal Diameter
98566	13mm, 1/2"
97879	15mm, 5/8"
99484	19mm, 3/4"
97880	25mm, 1"
99483	32mm, 1 1/4"
98565	38mm, 1 1/2"

**Liquid Discharge-Water Delivery Hose PVC, White, Steel Wire Reinforced**



\* Sold by linear meter

**new Nozzle and Pistol Grip with Male Quick Connector**



Code | 198132

**new**

**Male Quick Connectors**



41463

41464

41465

Code	Description
41463	Male quick connector with 3/4" female thread
41464	Male quick connector with 1/2" female thread
41465	Male quick connector with hose grip Ø20 (1/2")

**Female Quick Connectors**



198129

198130

198131

Code	Description
198129	Female quick connector with 3/4" female thread
198130	Female quick connector with 1/2" female thread
198131	Female quick connector with hose grip Ø20 (1/2") and "stop" valve



## Water & Waste Hoses



**Marine Wet Exhaust Hose  
SCAMO/SP/CAJ, Rubber**

Code	Internal Diameter
97615	38mm, 1 1/2"
97616	45mm, 1 3/4"
97617	51mm, 2"
97618	60mm, 2 3/8"
97619	76mm, 3"

\* Sold by linear meter



**Pleasure Boat Sanitary Hose  
ALIMPOMP/SAN, PVC**

Code	Diameter	
	Internal	External
99016	20mm, 25/32"	27mm
99017	25mm, 1"	33mm
99018	38mm, 1 1/2"	48mm

\* Sold by linear meter



**Pleasure Boat Sanitary Hose  
SANIPOMP/EXTRA**

Code	Diameter (mm)	
	Internal	External
99489	19	29
99490	25	35
99491	38	48

\* Sold by linear meter



**Liquid Discharge and Water Delivery  
Hose, PVC, with Internal Spiral, Airflex/N**

Code	Internal Diameter
71954	25mm (1")

\* Sold by linear meter

Plumbing & Ventilation

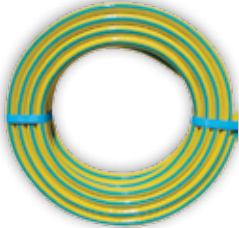

**Water Hose, General Use, 25m,  
Internal Thread 15mm (5/8")**

Code | 73600



**Set of Hose Adaptors, Threaded  
15mm (5/8"), Male & Female**

Code | 73601

## Hose Clamps

### Heavy-Duty Hose Clamp, Inox 316

Nuova Rade hose clamps are designed for heavy-duty secure hose connections, such as with exhaust hoses. They are made of Inox 316 for the ultimate resistance to corrosion. They also feature smooth imperforated band surface and rolled edges, so as to prevent hose damage. Available in various sizes, with band spreads from 3 to 8 mm.

	DIN	AISI/AS	BS	AFNOR NF	SUS
Hose clamps	1.4401	316	316S16	Z6CND17.12	316
Screw	1.4401	316	316S16	Z6CND17.12	316

**INOX  
316**



INOX 316	Code	10283	10284	10285	10286	10287	10288	10289	10290	10291	10292	10293	10294	10295	10296	10297	10298	10299
	Width(mm)	20	22	22	22	22	22	22	24	24	24	24	24	24	24	24	24	26
	Diameter(mm)	40-43	44-47	47-50	52-55	56-59	60-63	64-67	68-73	74-79	80-85	86-91	92-97	98-103	104-112	113-121	122-130	131-139

### Hose Clamp, Inox 316 & 304

Nuova Rade hose clamps are especially designed for marine use, with band, housing and screw all fully made of Inox for extra resistance to corrosion. They feature fixed housing and beveled edges, whereas the complete smoothness of the internal surface will definitely protect from any kind of hose damage. Nuova Rade hose clamps are available in various sizes with band spreads from 8mm to 20mm.

	DIN	AISI/AS	BS	AFNOR NF	SUS		DIN	AISI/AS	BS	AFNOR NF	SUS
Hose clamps	1.4401	316	316S16	Z6CND17.12	316	Hose clamps	1.4301	304	304S15	Z6CN18.09	304
Screw	1.4401	316	316S16	Z6CND17.12	316	Screw	1.4301	304	304S15	Z6CN18.09	304

INOX 316	Code	11113	11115	11117	11119	11121	11123	11125	11127	11130
	Width(mm)	9				12				
	Diameter(mm)	8-16	16-25	25-40	20-32	32-50	50-70	70-90	90-110	120-140

**INOX  
316**

INOX 304	Code	11479	11481	11483	11484	11486	11489	11490
	Width(mm)	9				12		
	Diameter(mm)	8-16	16-25	25-40	16-27	25-40	50-70	60-80

**INOX  
304**





**Straight Coupling, BSPP, Brass**

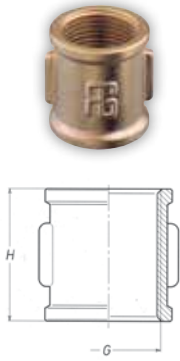

Code	Weight(gr)	H	G
90144	25	27	1/4"
90145	40	30	3/8"
90146	63	32	1/2"
90147	83	35	3/4"
90148	140	43	1"
90149	200	47	1 1/4"
90150	250	52	1 1/2"

**Straight Reducing Coupling, F-F, BSPP, Brass**

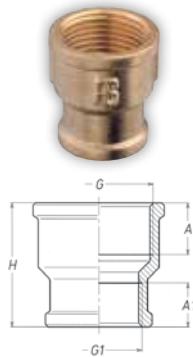

Code	Weight(gr)	H	A1	A	G1	G
96181	27	26	10	12	1/8"	3/8"
96182	27	26	11	12	1/4"	3/8"
96183	42	31	11	12	1/4"	1/2"
90097	44	31	12	12	3/8"	1/2"
96184	70	36	13	15	3/8"	3/4"
90099	78	36	13	15	1/2"	3/4"
90100	105	42	15	19	1/2"	1"
90101	115	42	16	19	3/4"	1"

**Male Plug, BSPT, Brass**

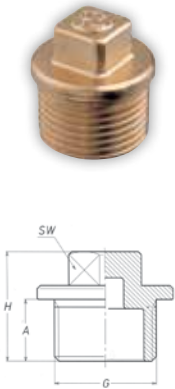

Code	Weight(gr)	SW	H	A	G
96202	10	8	20	9	1/8"
96203	13	8	21	10	1/4"
96204	20	10	22	11	3/8"
96205	35	11	25	12	1/2"
96206	65	17	30	15	3/4"
96207	120	19	35	20	1"
96208	160	22	37	21	1 1/4"
96209	200	22	40	24	1 1/2"
96210	310	27	44	26	2"

**Reducing Male Nipple, BSPT, Brass**

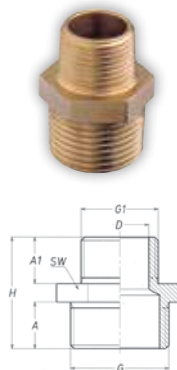

Code	Weight (gr)	SW	D	H	A1	A	G1	G
96190	18	16	6	28	11	12	1/8"	1/4"
96191	30	19	8,5	33	13	14	1/4"	3/8"
96192	40	23	12	35	14	15	3/8"	1/2"
96193	65	28	16	42	16	18	1/2"	3/4"
96194	105	35	16	44	16	20	1/2"	1"
96195	115	35	20	46	18	20	3/4"	1"
96196	180	48	26	49	20	22	1"	1 1/4"
96197	255	54	34	55	22	24	1 1/4"	1 1/2"
96198	400	67	39	58	24	25	1 1/2"	2"

**Elbow 90°, F-F, BSPP, Brass**



Code	Weight(gr)	H	A	G
96176	30	20	10	1/8"
90049	45	22	11	1/4"
90050	50	23	12	3/8"
90051	90	28	14	1/2"
90052	120	33	15	3/4"
90053	225	39	18	1"
90054	290	44	19	1 1/4"
90055	325	46	19	1 1/2"
90056	550	56	23	2"

**Elbow 90°, M-F, Brass**

Male BSPP & Female BSPT

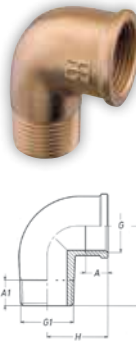

Code	Weight(gr)	L	H	A1	A	G-G1
96177	25	23	20	8	10	1/8"
90062	45	28	22	11	11	1/4"
90063	55	29	23	11	12	3/8"
90064	90	36	29	13	14	1/2"
90065	140	40	32	15	15	3/4"
90066	260	48	38	18	18	1"
90067	325	60	43	22	21	1 1/4"
90068	425	63	46	23	21	1 1/2"
90069	625	70	56	23	23	2"

**Bend, Male Type, BSPP, with Hose Connector, Brass**



Code	Weight(gr)	SW	L	H	A	P	G-G1
90073	50	19	38	30	10	15	3/8"
90074	83	23	41	32	12	20	1/2"
90075	130	30	43	40	12	25	3/4"
90076	185	35	51	45	13	30	1"

**Male Nipple, BSPT, Brass**

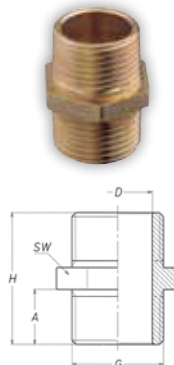

Code	Weight(gr)	SW	D	H	A	G
90155	20	16	8,5	29	12	1/4"
90156	30	19	12	35	14	3/8"
90157	45	23	16	40	16	1/2"
90158	80	28	20	44	18	3/4"
90159	130	38	26	47	20	1"
90160	190	48	34	50	21	1 1/4"
90161	260	54	40	57	24	1 1/2"
90162	410	67	51	61	25	2"



# Brass Fittings

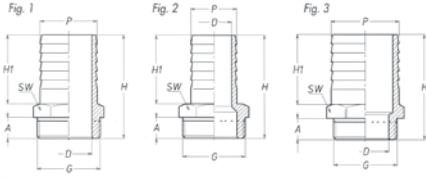

## Male Hose Connector "Extra", BSPP, Brass

Code	Fig.	Weight(gr)	SW	H	H1	A	D	P	G
96341	2	275	53	74	48	16	39	45	1 1/2"
90218	3	300	53	74	48	16	40	50	1 1/2"
96311	2	14	16	32	17	8	6	8	1/4"
96312	2	19	16	40	254	9	7	10	1/4"
96313	1	20	16	40	24	9	8,5	12	1/4"
96315	2	25	19	42	25	10	7	10	3/8"
96316	2	28	19	42	25	10	9	13	3/8"
96317	2	30	19	42	25	10	11	15	3/8"
96318	2	32	23	44	25	12	7	10	1/2"
96319	2	40	23	50	31	12	8,5	12	1/2"
96320	2	44	23	50	31	12	10	14	1/2"
96321	2	46	23	50	31	12	12	16	1/2"
90191	2	48	23	50	31	12	15	19	1/2"
90192	1	50	23	50	31	12	16	20	1/2"
96322	1	65	23	50	31	12	16	22	1/2"
96323	2	50	30	43	24	12	10	13	3/4"
96324	2	65	30	50	31	12	12	16	3/4"
96325	2	80	30	55	35	12	14	19	3/4"
96326	2	85	30	55	35	12	15	20	3/4"
96327	2	86	30	55	35	12	17	22	3/4"
90199	1	100	30	56	37	12	19	25	3/4"
96328	3	95	28	55	37	12	19	28	3/4"
96329	2	115	36	57	35	13	15	20	1"
90202	2	130	36	59	37	12	19	25	1"
96330	2	130	35	58	37	12	22	28	1"
96331	1	130	36	59	37	12	24	30	1"
90205	3	140	36	62	41	12	25	32	1"
96333	2	175	45	65	42	14	24	30	1 1/4"
96336	2	182	45	65	42	14	32	38	1 1/4"
90212	1	195	45	65	42	14	34	40	1 1/4"
96340	2	265	53	74	48	16	34	40	1 1/2"

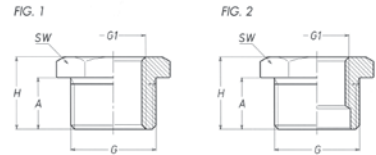

## Straight Reducer, M-F, BSPT, Brass

Code	Fig.	Weight(gr)	SW	H	A	G	G1
96185	1	10	16	16	11	1/4"	1/8"
96186	2	20	19	17	12	3/8"	1/8"
90110	1	15	19	17	12	3/8"	1/4"
90111	2	35	23	20	14	1/2"	1/4"
96187	1	25	23	20	14	1/2"	3/8"
96188	1	35	24	20	14	5/8"	3/8"
90114	2	60	28	22	16	3/4"	1/4"
96189	2	52	28	22	16	3/4"	3/8"
90116	1	40	28	22	16	3/4"	1/2"
90117	2	100	35	25	18	1"	3/8"
90118	2	93	35	25	18	1"	1/2"
90119	1	73	35	25	18	1"	3/4"
90120	2	108	48	29	21	1 1/4"	3/4"
90121	2	140	48	29	21	1 1/4"	1"
90122	2	285	54	33	24	1 1/2"	3/4"
90123	2	240	54	33	24	1 1/2"	1"
90124	1	165	54	33	24	1 1/2"	1 1/4"
90125	2	400	67	35	25	2"	1 1/4"
90126	2	330	67	35	25	2"	1 1/2"

Plumbing & Ventilation

## "TEE" Fitting, BSPP, Brass

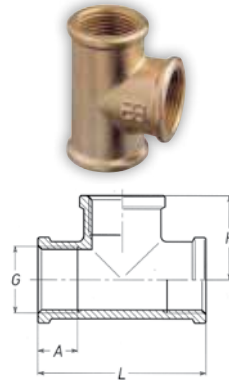

Code	Weight(gr)	L	H	A	G
90079	60	42	21	11	1/4"
90080	100	47	24	12	3/8"
90081	110	49	25	13	1/2"
90082	180	60	30	15	3/4"
90083	260	70	35	18	1"
90084	390	85	43	19	1 1/4"
90085	580	96	48	22	1 1/2"

## Grated Water Intake, BSPP, Brass

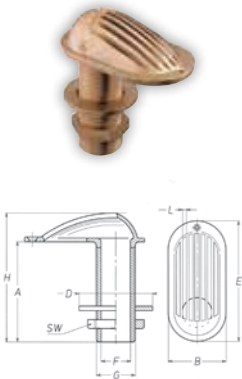

Code	Weight(gr)	SW	H	A	F	D	L	E	B	G
90254	240	23	94	71	11	33	2,5	81	45	3/8"
90255	330	26	103	76	14	38	2,5	89	52	1/2"
90256	480	32	102	76	19	48	3	106	59	3/4"
90257	560	38	104	76	25	55	3	118	60	1"
90258	810	49	118	89	32	64	3	123	65	1 1/4"
90259	965	56	119	88	37	72	3	134	72	1 1/2"
90260	1510	68	136	99	48	88	3	160	85	2"

## Female Plug, BSPP, Brass

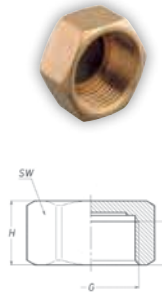



Code	Weight(gr)	SW	H	A	G
96211	10	13	13	10	1/8"
96212	17	17	15	11	1/4"
96213	25	20	16	11	3/8"
96214	40	25	17	13	1/2"
96215	75	32	21	15	3/4"
96216	105	39	21	15	1"
96217	108	48	25	19	1 1/4"
96218	207	53	26	21	1 1/2"
96219	340	66	30	24	2"

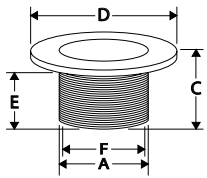

### Thru-Hull with Flush Flange Threaded



Code	Colour	Thread Ø A (inch)*	Overall Length C (mm)	Flush Flange Ø D (mm)	Thread Length E (mm)	Int. Ø F (mm)	Material	Optional Plug
44737	White	1/2"	74	40	66	15	PA	-
14186	White	3/4"	77	44	70	19	PA	-
44740	White	3/4"	81	48	71	18	PA	-
44743	White	1"	87	53	75	24	PA	 45309
198218	White	1 1/4"	98	63	86	30	PA	-
44746	White	1 1/2"	98	75	86	36	PA	 45307
198221	White	2"	110	90	97	45	PA	-



### Thru-Hull Easy Mount Threaded with Hose Barb

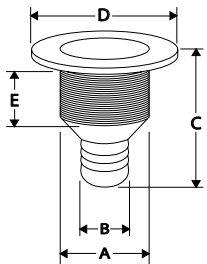

Code	Colour	Thread Diameter Ø A (inch)*	Hose Ø B (mm)	Overall length C (mm)	Flush Flange Ø D (mm)	Thread Length E (mm)	Material	Optional plug
23669	White	3/4"	21	89	45	39	PA	-
39473	White	7/8" (30mm)	25	80	53	39	PA	 45306
23671	White	1 1/4"	28/35	125	61	45	PA	-
16710	White	1 1/2"	38 or 1 1/4" seacock	121	70	50	PA	-



Plumbing & Ventilation





Combine with Polyurethanes page 394

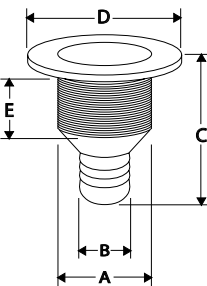

### Thru-Hull with Flush Flange and Hose Barb



Code	Colour	Thread Ø A (inch)*	Hose Ø B (mm)	Overall Length C (mm)	Flush Flange Ø D (mm)	Thread Length E (mm)	Material	Optional Plug
44696	White	5/8"	15	75	43	40	PA	-
198223	White	1/2"	14	85	40	39	PA	-
44705	White	3/4"	20	88	48	40	PA	-
44714	White	1"	26	97	53	47	PA	 45309
198227	White	1 1/4"	33	107	63	47	PA	-
44729	White	1 1/2"	32	102	76	55	PA	-
44735	White	1 1/2"	32	102	76	65	PA	-
44723	White	1 1/2"	39	107	75	47	PA	 45307
198230	White	2"	52	120	90	60	PA	-



\*According to BSP thread dimensions

## Thru-Hull with Flush Flange and Hose Barb



Code	Colour	Thread Diameter Ø A (inch)*	Hose Ø B (mm)	Overall length C (mm)	Flush Flange Ø D (mm)	Thread Length E (mm)	Material	Optional plug	Optional Non-Return Valve
10250	White	1"	19	81	45	36	PP		-
10251	White	1"	25	81	45	36	PP		
10252	White	1 1/2"	32	98	73	50	PP		-
10253	White	1 1/2"	42	93	73	48	PP		
10256**	White	1 1/2"	32	93	73	50	PP	-	-
10257**	White	1 1/2"	42	93	73	48	PP	-	-

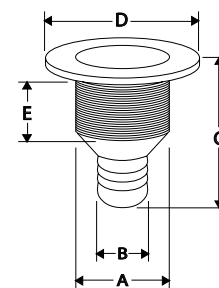

\*\* with non-return valve

Plumbing & Ventilation



Chrome plated with plastic nut

Code	Colour	Thread Diameter Ø A (inch)*	Hose Ø B (mm)	Overall length C (mm)	Flush Flange Ø D (mm)	Thread Length E (mm)	Material	Optional plug	Optional Non-Return Valve
70597	Chrome	1"	19	82	45	36	PP		-
70598	Chrome	1"	25	82	45	36	PP		
70600	Chrome	1 1/2"	42	94	74	50	PP		-
70603*	Chrome	1 1/2"	42	94	74	50	PP		

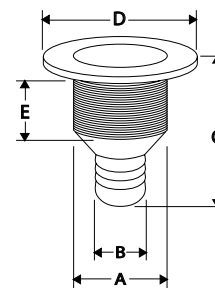

\*\* with non return valve



Code	Colour	Thread Diameter Ø A (inch)*	Hose Ø B (mm)	Overall length C (mm)	Flush Flange Ø D (mm)	Thread Length E (mm)	Material	Optional plug	Optional Non-Return Valve
31351	Black	1 7/8"	39	93	72	50	PP		

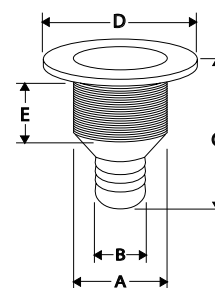



Thru-Hull Threaded with Standard Flange

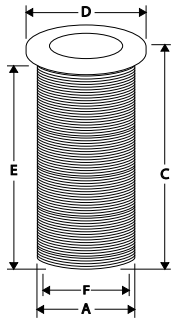

Code	Colour	Thread Diameter Ø A (inch)*	Overall length C (mm)	Flush Flange Ø D (mm)	Thread Length E (mm)	Int. Ø (F) (mm)	Material	Optional plug	Optional Non-Return Valve		
198067	Black	3/4" (25mm)	153	39	148	15	PA	-	-		
195527	White	3/4" (25mm)	153	39	148	15		-	-		
43499	Black	7/8" (30mm)	155	39	150	22		45306	45391		
43497	White	7/8" (30mm)	155	39	150	22					
43498	Grey	7/8" (30mm)	155	39	150	22					
47756	Cream	7/8" (30mm)	155	39	150	22					
43491	Black	7/8" (30mm)	62	39	58	22					
43489	White	7/8" (30mm)	62	39	58	22					
47755	Cream	7/8" (30mm)	62	39	58	22					
43490	Grey	7/8" (30mm)	62	39	58	22					
43537**	Black	1" (33mm)	155	39	150	25				45322	45393
43535**	White	1" (33mm)	155	39	150	25					
43536**	Grey	1" (33mm)	155	39	150	25					
43529**	Black	1" (33mm)	62	40	57	25					
43527**	White	1" (33mm)	62	40	58	25					
43528**	Grey	1" (33mm)	62	40	58	25					
47758**	Cream	1" (33mm)	62	40	58	25					
196073**	Black	1" (33mm)	76	42	70	25					
47122**	White	1" (33mm)	76	42	70	25					



\*\*Meets the EN ISO 11812:2001-7, 4 standard

Combine with Polyurethanes page 394

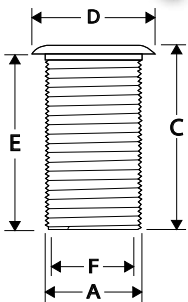

Code	Colour	Thread Diameter Ø A (inch)*	Overall length C (mm)	Flush Flange Ø D (mm)	Thread Length E (mm)	Int. Ø F (mm)	Material	Optional plug	Optional Valve	Optional Elbow
197211	White	1"	87	50	82	24	PA	-	-	-
196995	White	1 1/2"	62	64	54	39	PA	45312	197023	197065
197003	White	1 1/2"	92	64	84	40	PA	-	197024	197061
197017	White	2"	117	72	110	48	PA			
197011	White	2"	72	72	65	48	PA			



Plumbing & Ventilation

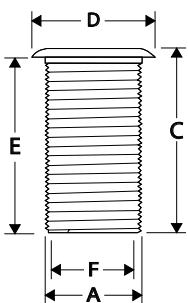

Code	Colour	Thread Diameter Ø A (inch)*	Overall length C (mm)	Flush Flange Ø D (mm)	Thread Length E (mm)	Int. Ø F (mm)	Material	Optional plug	Optional Valve	Optional Elbow
197213	Inox 316	1"	87	50	82	24	PA	-	-	-
196999	Inox 316	1 1/2"	62	64	54	39	PA	45312	197023	197065
197007	Inox 316	1 1/2"	92	64	84	40	PA			
197014	Inox 316	2"	72	72	65	48	PA			
197020	Inox 316	2"	118	72	72	48	PA	-	197024	197061



\*According to BSP thread dimensions  
www.marinastores.gr

## Thru-Hull Threaded with Hose Barb

Code	Colour	Thread Diameter Ø A (inch)*	Hose Ø B (mm)	Overall length C (mm)	Flush Flange Ø D (mm)	Thread Length E (mm)	Material	Optional plug	Optional Valve
196997	White	1 1/2"	38	87	64	56	PA		
197005	White	1 1/2"	38	117	63	86	PA		
196998	White	1 1/2"	45	86	63	58	PA		
197006	White	1 1/2"	45	117	63	86	PA		
197012	White	2"	51	122	72	55	PA	-	
197018	White	2"	51	167	72	100	PA		
197013	White	2"	55	121	72	55	PA		
197019	White	2"	55	167	72	100	PA		
197218	Inox 316	3/4"	19	82	40	43	PA		
197001	Inox 316	1 1/2"	38	87	64	56	PA		
197002	Inox 316	1 1/2"	45	87	64	56	PA		
197009	Inox 316	1 1/2"	38	117	64	86	PA		
197010	Inox 316	1 1/2"	45	117	64	85	PA	-	
197015	Inox 316	2"	51	122	72	56	PA		
197021	Inox 316	2"	51	167	72	100	PA		
197016	Inox 316	2"	55	122	72	55	PA	-	
197022	Inox 316	2"	55	167	72	100	PA		

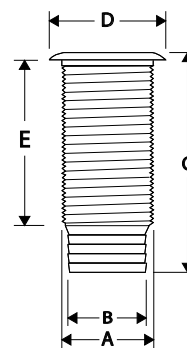

Plumbing & Ventilation

Combine with Polyurethanes page 394

## Thru-Hull Threaded with Standard Flange and Hose Barb

Code	Colour	Thread Diameter Ø A (inch)*	Hose Ø B (mm)	Overall length C (mm)	Flush Flange Ø D (mm)	Thread Length E (mm)	Material	Optional plug
43508	White	7/8" (30mm)	25	100	40	70	PA	
43509	Grey	7/8" (30mm)	25	100	40	70		
47757	Cream	7/8" (30mm)	25	100	40	70		
43510	Black	7/8" (30mm)	25	100	40	70		
43543	White	1"	30	100	42	70		
43544	Grey	1"	30	100	42	70		
43545	Black	1"	30	100	42	70		
95793	White	7/8" (30mm)	25	126	40	92	PP	

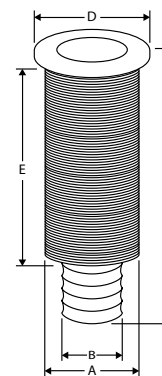

\*According to BSP thread dimensions

\*According to BSP thread dimensions



**Thru-Hull Threaded with Displaced Hose Bard**

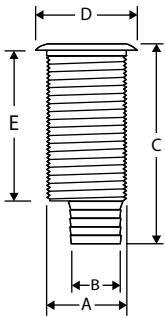

Code	Colour	Thread Diameter Ø A (inch)*	Hose Ø B (mm)	Overall Length C (mm)	Flush Flange Ø D (mm)	Thread Length E (mm)	Material	Optional plug	Optional Valve
196996	White	1 ½"	31	87	64	57	PA		
197004	White	1 ½"	31	117	64	86	PA		
197000	Inox 316	1 ½"	31	87	64	57	PA		
197008	Inox 316	1 ½"	31	117	64	86	PA		



**Thru-Hull Kit**

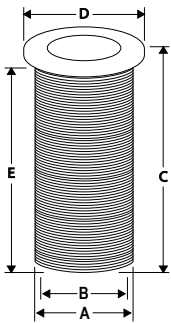

- Complete set including :**
- A 7/8" (30mm) thru-hull fitting with threaded end (43491).
  - A black expanding plug (45306).
  - An outlet with non-return valve (45391).

Code	Thread Diameter Ø A (inch)*	Hose Ø B (mm)	Overall length C (mm)	Flush Flange Ø D (mm)	Thread Length E (mm)
44092	7/8" (30mm)	22,7	62	39	58

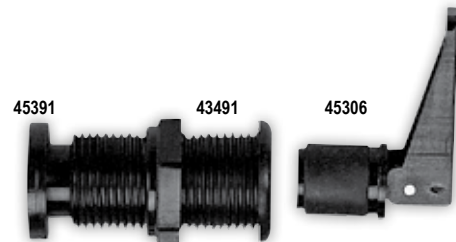

Plumbing & Ventilation

**Thru-Hull Elbow 90°**

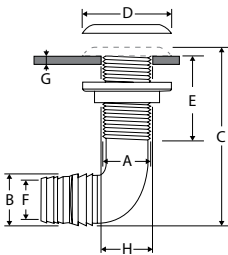

- Elbow thru-hulls are the answer to the most common plumbing issues:
- Allow major room saving, as they can be used with a hose running along the hull.
  - Avoid making a bend in the hose, which can sometimes be a source of leak or breakage.
  - Require a simplified installation process inside the hull, carried out by one person only. You can hold it firmly with one hand, while screwing with the other hand.

Code	Colour	Thread Diameter Ø A (mm)	Hose Ø B (mm)	Int. Ø F (mm)	Flush Flange Ø D (mm)	Thread Length E (mm)	Overall length C (mm)	Cut-out Ø H independent of hull thickness G (mm)	Material
10254	White	30,7	24,5	20,5	60	46	105	Ø 32mm	PP
70601	White	30,7	24,5	20,5	60	46	105	Ø 32mm	PP



With Chrome plated cap

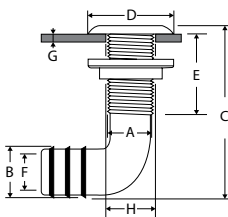

Code	Colour	Thread Diameter Ø A (mm)	Hose Ø B (mm)	Int. Ø F (mm)	Flush Flange Ø D (mm)	Thread Length E (mm)	Overall length C (mm)	Cut-out Ø H independent of hull thickness G (mm)	Material
10255	White	31	24	20,5	59	55	110	Hull thickn. <20mm Ø 33mm	PP
39548	White	26,3	20,8	14,7	45	40	84	Hull thickn. <20mm Ø 28mm	PA
39549	White	30,3	26,2	19	53	40	90,5	Hull thickn. <20mm Ø 33mm	PA
39550	White	48	39	31,7	70	45	114	Hull thickn. <20mm Ø 50mm	PA



## Thru-Hull Threaded with Non-Return Valve

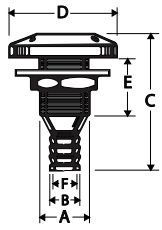

Code	Colour	Thread Diameter Ø A (mm)	Hose Ø B (mm)	Overall length C (mm)	Flush Flange Ø D (mm)	Thread Length E (mm)	Int. Ø F (mm)	Material
43251	White	55	-	116	75	-	41	PA
43248	White	55	45	116	75	78	37	PA
43253	White	55	50	116	75	60	41	PA

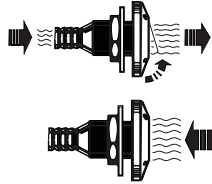

43248



43253



## Thru-Hull with Non-Return Valve



Code	Colour	Thread Diameter Ø A (mm)	Overall length C (mm)	Flush Flange Ø D (mm)	Thread Length E (mm)	Int. Ø F (mm)	Max Length Of Lid I (mm)	Material	Features
43242	Black	68	107	81	94	61	106	PA	With non return valve

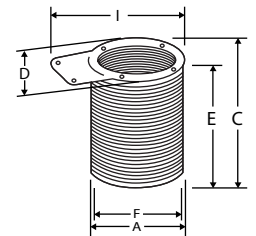

## Thru-Hull Telescopic



Code	Colour	Thread Diameter Ø A (mm)	Overall length C (mm)	Flush Flange Ø D (mm)	Thread Length E (mm)	Int. Ø F (mm)	Material	Features
44763	White	51	65-215	80	50-200	40	PA	With non return valve

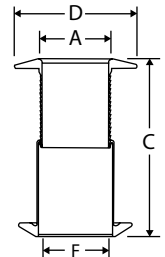

Code	Colour	Thread Diameter Ø A (inch)*	Overall length C (mm)	Flush Flange Ø D (mm)	Int. Ø F (mm)	Material
10258	White	1 1/4"	28-44	57	30	PP
10259	White	1 1/4"	48-75	54	30	PP

## Thru-Hull System with Flap



Code	Colour	Hose Ø B (mm)	Overall length C (mm)	Flush Flange Ø D (mm)	Thread Length E (mm)	Int. Ø F (mm)	Max Length Of Lid I (mm)	Second Part			Material
								J (mm)	K (mm)	L (mm)	
47088	White	79	170	107	150	70	130	103	55	45	PA

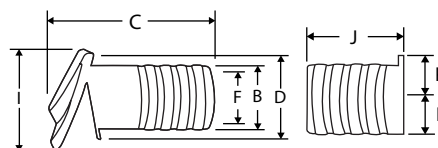

Drain Socket Cap

Code | 49672



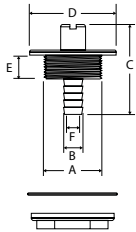

Thru-Hull Outlet

Code	Colour	Thread Diameter Ø A (inch)*	Hose Ø B (mm)	Overall length C (mm)	Flush Flange Ø D (mm)	Thread Length E (mm)	Int. Ø F (mm)	Material
31352	Black	1 1/2"	16	75	71	20	12	PA

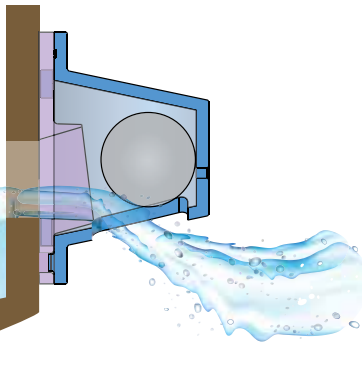

Ball Scupper Drain Valve, 72mm

- Automatically seals and drains a self-bailing deck
- Reduced noise
- To be mounted above waterline
- Designed to retrofit codes
- Same drill pattern to codes 43248, 43251, 43253, 44763
- Fits Hole:** up to Ø40mm (Ø1.5")
- Dimensions:** Ø72mm x H 48mm (Ø2.8" x H 1.9")



Code | 198091



Code | 198092

Ball Scupper Drain Valve, 114mm

- Automatically seals and drains a self-bailing deck
- Reduced noise
- To be mounted above waterline.
- Fits Hole:** up to Ø75mm (Ø3")
- Dimensions:** Ø114" x H 74" (Ø4.5" x H 2.9")

Plumbing & Ventilation

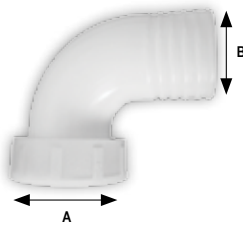

Thru-Hull 90°, Female Connector, White

Code	Locking Nut Thread A (inch)	Hose Ø B (mm)
197065	1 1/2"	40
197061	2"	50



Code | 72133

Inlet Elbow Fitting for Ø38mm Hose, 1 1/2" Thread Tightening Ring, Black



Code | 72134

Outlet Elbow Fitting for Ø12mm Hose, 1 1/2" Thread Tightening Ring, Black

Connectors



	Code	Description	Model	Ø (mm)
A	196906	Straight	G 3/4"	16
	196904		G 3/4"	20
	196915		G 3/4"	25
B	196914	Straight	G 1 1/4"	25
	196913		G 1 1/4"	38
C	196925	Straight	G 1 1/2"	25

	Code	Description	Model	Ø (mm)
D	196917	Straight	G 1 1/2"	38
	196902		G 1 1/2"	38
F	196905	90°	G 3/4"	20
	196916		G 3/4"	25
	196918		G 1 1/2"	38
H*	196901	Straight	G 1 1/2"	38

\*Set of 3pcs

## Non-Return Valves

The non-return valves are ideal for use in hydraulic installations. They feature a quick release clip, allowing you to service them easily and quickly. They are available as inline units or with a 90° curve. Their outlet connection allows the use of either a Ø ¾ - 1" or a 1 ¼ - 1 ½" hose.

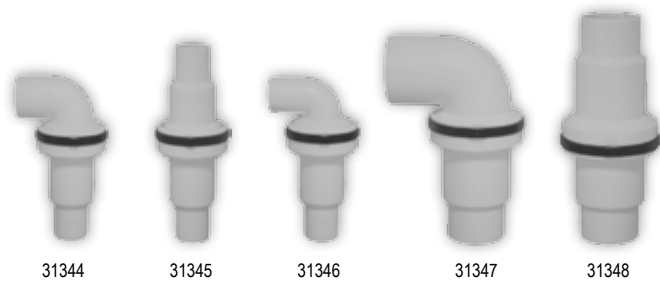

Code	31344	31345	31346	31347	31348
Hose Outlet	1"	¾" - 1"	¾"	1½"	1½" - 1¼"
Hose Inlet	¾" - 1"	¾" - 1"	¾" - 1"	1½" - 1¼"	1½" - 1¼"
Angle	90°	Inline	90°	90°	Inline

## Non-Return Valve



Code	Diameter (mm / inch)
197023	Ø 40 / 1 ½"
197024	Ø 50 / 2"

## Spare Parts Kit for Non-Return Valve

External Ø 7,6mm, Internal flange Ø 7cm



Code	44093
------	-------

Plumbing & Ventilation



Code	Description
43500	Drain Plug with Non-return Valve for Inflatable Boat, Ø35mm, Black
45310	Drain Plug Rubber, Ø35mm, Black
45307	Expanding Drain Plug, Ø35mm, Black
45312	Expanding Drain Plug, Ø40mm, Black
44230	Spare Part for Non-return Valve, Rubber

Code	Description
45306	Expanding Drain Plug, Ø22mm, Black
45322	Expanding Drain Plug, Ø25mm, Black
45309	Expanding Drain Plug, Adjustable, Ø22mm, Black
45391	Drain Plug with Non-return Valve for Thru-hull, Ø22mm, Black
45393	Drain Plug with Non-return Valve for Thru-hull, Ø25mm, Black

## Through Hull Outlet with Hose Connector, Chromium Plated Brass

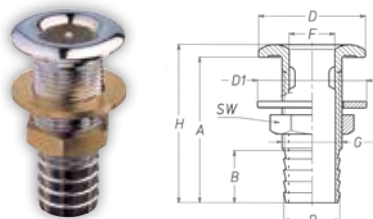

Code	Weight(gr)	SW	H	A	F	D1	D	B	P	G
90307	80	23	57	53	12	33	34	18	15	3/8"
90308	110	26	65	60	15	38	37	22	18	1/2"
90309	190	32	70	65	20	48	47	22	24	3/4"
90310	320	38	85	80	25	55	55	27	30	1"
90311	435	49	86	80	33	64	64	27	39	1 1/4"
90312	620	56	96	90	39	72	72	27	45	1 1/2"

Through Hull Outlet, Chromium Plated Brass

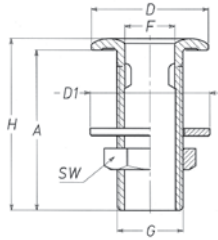

Code	Weight(gr)	SW	H	A	F	D	D1	G
90296	40	20	62	58	8	22	22	1/4"
90297	85	23	57	53	12	34	33	3/8"
90298	125	26	65	60	15	37	38	1/2"
90299	205	32	70	65	20	47	48	3/4"
90300	350	38	85	80	25	55	55	1"
90301	470	49	86	80	33	64	64	1 1/4"
90302	650	56	96	90	39	72	72	1 1/2"
90303	990	68	107	100	50	85	88	2"
90304	1950	92	130	122	63	110	112	2 1/2"

Through Hull Outlet, Brass

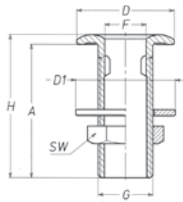

Code	Weight(gr)	SW	H	A	F	D	D1	G
90266	40	20	62	58	8	22	22	1/4"
90267	85	23	57	53	12	34	33	3/8"
90268	125	26	65	60	15	37	38	1/2"
90269	205	32	70	65	20	47	48	3/4"
90270	350	38	85	80	25	55	55	1"
90271	470	49	86	80	33	64	64	1 1/4"
90272	650	56	96	90	39	72	72	1 1/2"
90273	990	68	107	100	50	85	88	2"

Expanding Drain Plug

The expanding drain plugs series includes 4 drain plugs of different diameter for different drain sizes. They are made of nylon, supplied in black colour and each of the drain plugs can be applied to specific drains of LALIZAS drain series.



Code	Diameter (mm)	Suitable for Drains
95790	22	95793
95786	25	10250, 10251, 10254 & 10255
95787	35	10259
95785	40	10252, 10253, 10256 & 10257



Drain Plugs



Buoyancy Tank Drain Socket, with captive plug

Internal diam.: 18 mm,  
External diam.: 23 mm

Code | 16687

new



Non-return Drain Valve Set, with plug for 25mm Transom, Grey

Code | 74449



Captive Plug with O-Ring for Drain Socket

Code	Colour
45276	White
45277	Black



Plug for Drain Socket, White

Code | 16713

# Drain Plugs



## Drain Socket with plug



Code	Specifications	Colour	Flange Dimensions (mm)	Overall Height (mm)	Height of Socket (mm)	Cutout Diameter (mm)	Depth Below Deck (mm)	Mini Internal Diameter (mm)
16688	Plain	White	48 x 36	28	19,5	27	15	19
16689	With 2 holes	White						
43462	With captive plug	White	54 x 33	55	25	27	20	19
43463	With captive plug	Black	54 x 33	55	25	27	20	19
95781	With captive plug	White	60x30	52	23	27	18	19
95782	With captive plug	Black	60x30	52	23	27	18	19
43468	With captive plug	White	Ø 40	55	25	27	20	19
43469	With captive plug	Black	Ø 40	55	25	27	20	19
43478	With 4 holes	Black	Ø 43	38	27	25	22	16,5
43477	With 4 holes	White	Ø 43					
16691	With captive plug	White	Ø 46	63	27	28	21	19
16690	Plain	White	Ø 48	76	66	28	62	19
16797	"Fast Lock"	White	Ø 43	107	96	27	91	19

## Wood Drain Plug

Code 71965

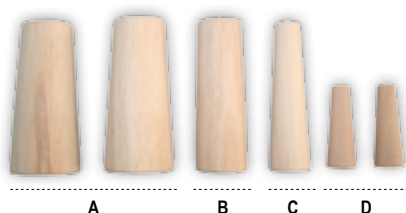

	Number of pieces	Max diam.	Small diam.	Length
A	2	51 mm	38 mm	110 mm
B	1	38 mm	33 mm	110 mm
C	1	30 mm	19 mm	110 mm
D	2	22 mm	13 mm	62 mm

## Ball Valves

### Valve "Y"

It allows water to flow in two different ways or to distribute in two ways.



Code	For Hose Diameter (mm)
95719	25
95720	38

### Ball Valve, PVC



Code	Ø A (in.)
90373	1/2
90374	3/4
90375	1
70979	1 1/4
70980	1 1/2



## Ball Valves



**Ball Valve, Single Union, BSPP, Plastic, with Orange Handle**

Code	A (mm)	B (mm)	C (mm)	D (inches)	E (mm)	F (mm)	G (mm)	Weight (g)
198112	68	13	80	1"	22	58	102	250
198084	96	87	103	1 1/2"	31	74	136	580
198085	116	101	120	2"	38	92	168	1030

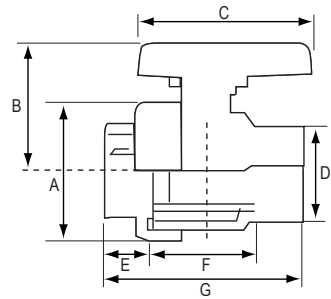

**Hose Adaptor for Valve, Threaded BSPP, Plastic**

Code	G Ø (inches)	Ø A (mm)
198113	1"	32
198086	1 1/2"	50
198087	2"	60

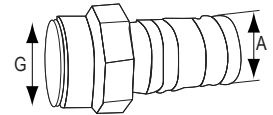

**Through Hull Outlet, Brass**

Code	Weight (gr)	SW	H	A	F	D	D1	G
90270	350	38	85	80	25	55	55	1"
90272	650	56	96	90	39	72	72	1 1/2"
90273	990	68	107	100	50	85	88	2"

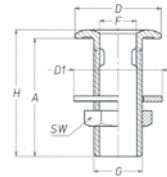

**Ball Valve, Single Union BSPT, Plastic, with Blue Handle**

Code	A (mm)	B (mm)	C (mm)	D (inches)	E (mm)	F (mm)	G (mm)	Weight (g)
44669	48	44	78	1/2"	21	52	93	137
44670	60	54	90	3/4"	24	60	104	205
44671	70	64	103	1"	26	66	122	310
44672	82	72	110	1 1/4"	30	74	138	464
44673	94	86	120	1 1/2"	34	84	152	655

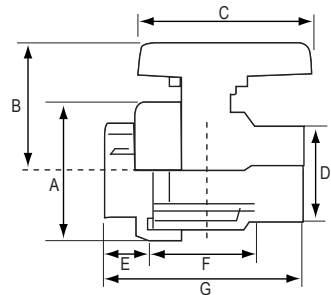

**Hose Adaptor For Valve, Threaded BSPT, Plastic**

Code	G Ø (inches)	Ø A (mm)	Ø B (mm)
44538	1/2"	16	17
44539	3/4"	19	20
44540	1"	29	30

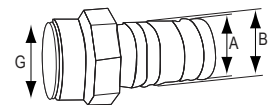

Plumbing & Ventilation



## Ventilation



**Ventilation Shaft Grilles, White**

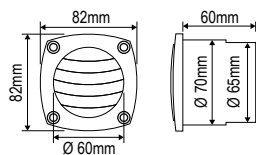

Code | 12410



**Ventilation Shaft Grilles Cover, PA**

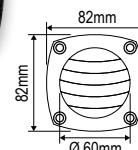

Code	Colour
12409	White
16307	Grey
16308	Black

**Ventilation Shaft Grilles Cover, ASA**



Code	Colour	Dimensions (mm)
16311	Black	200 x 100
17657	White	200 x 100

**Ventilation Shaft Grilles Cover**

- Suitable for interior and exterior use
- Salt water resistant
- UV-resistant

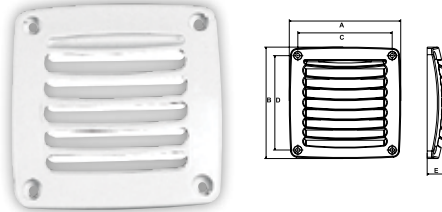

Code	Colour	A (mm)	B (mm)	C (mm)	D (mm)	E (mm)
47063	White	92	92	73	73	12
50152		118	118	99,93	100	19,9

Plumbing & Ventilation

Code	Description	Colour	Dimensions (mm)
44545	Detachable double ventilation - ASA	White	255 x 115
44546		Black	255 x 115

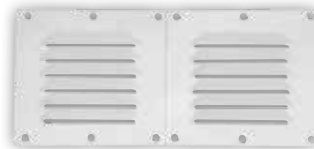

**Ventilation Shaft Grilles, Double, ASA**

It connects two ventilation exhausts behind one single louvered vent.



**Ventilation Shaft Grilles Cover, ASA**

Code	Colour	Dimensions (mm)
47065	White	206 x 106

**Ventilator with Water Outlet, ASA, White**

420 x 120mm (built-in 385 x 90 x 60)



Code | 44547

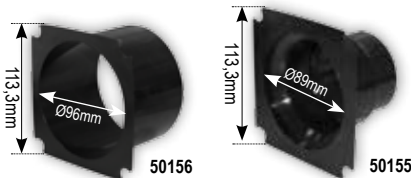

**Ventilator Connector, Black**

Code	Description	Hose Ø (mm)
50155	PA straight connector	65 / 75
50156		100



**Ventilation Clam Shell Cover, Round, Ø87mm, PA, White**

Code | 44551

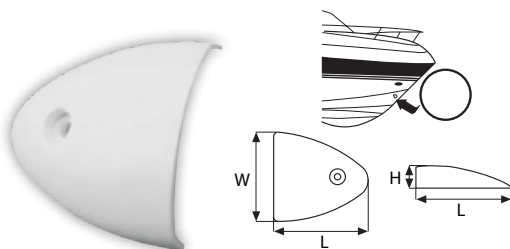

**Ventilation Clam Shell Cover, PA, White**

L55mm x W50mm x H12mm

Code | 31519



**Ventilation Clam Shell Cover**

For additional protection against heavy water intrusions. Suitable for 3" and 4" ventilators. To be fixed on top of the ventilator with 3 nylon fasteners. Made of polyamide, shock and UV-resistant. Compatible with common sealants and impervious to acetic acids. Dimensions: 215 x 180 x 70 mm

Code | 54386

Code	Colour	Dimensions (mm)
54391	White	195 x 105 Ø 3"



**Ventilation Shaft Grilles, Double, PP**

Connects two ventilation exhausts behind one single louvered vent. Offers multiple combinations in conjunction with two adaptors (flange, straight or elbow stiffening adaptors). The vent is simply clipped on the stiffening adaptors (90 mm space between the two holes).



### Ventilator Connector Ø 102mm

It is made of polypropylene, shock and load resistant, impervious to fuel and acetic acid. Notches and lugs hold the hose in position. In addition, the hose must be secured with stainless steel clamps. Connector is easy to fit, by means of 4 screws outside. When installing the blower, we recommend to place the exhaust louvered ventilator in a reasonably protected area (for example, in the cockpit rather than on the transom), so as to prevent water intrusion into the ventilation circuit. An extra precaution consists in building an elbow in the hose.

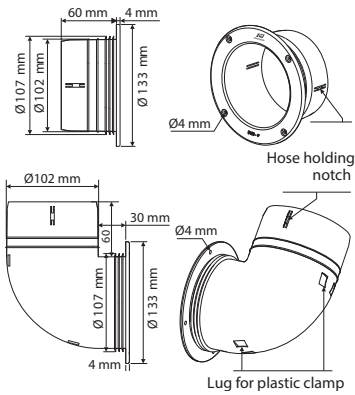

Code	Description	Material
51069	Elbow	PP
51070	Straight	
60071*	Shaft Grilles Cover	PEHD

\* Also available in other colour upon special request



51069

51070

60071

### Ventilator Connector Ø 76mm

Suitable for Ø 76,2 and 70 mm ducting hose. Made of polypropylene for a good UV-resistance. It is extremely shock and load resistant, compatible with common sealants and impervious to acetic acids. Made to support a hose along a bulkhead. On the straight model, ventilation is ensured by a louvered opening, which also prevents heavy water intrusions.

Quick and easy installation: Drill a Ø 76,2 mm hole. Notches ensure the perfect hold of the adapter in the bulkhead. Secure the adapter with 4 x M4 screws and sealant for waterproofness (compatible with most common sealants). Clip a louvered vent if necessary: moulded-in ribs contribute to the vent's secured position. Fit the hose on the adapter. Two lugs hold the hose, while waiting to be secured with stainless steel hose clips (not supplied).

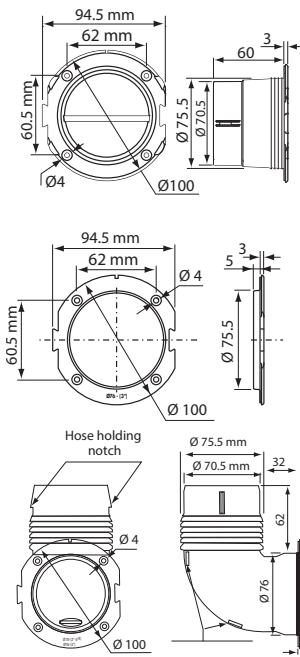

Code	Model
47514	straight
54389	elbow
54390	5 mm flange



54389

47514

54390

### Ventilation Shaft Grilles Cover, Ø76mm, ASA

Used either on its own to ventilate a locker or in conjunction with the stiffening adaptor for connection to a hose. No screws required and time-saving assembly.



Code	Colour
47515	White
47516	Grey
47517	Black





**Blower for Autonomous Solar Powered Fan**

Code	Volt	Battery
60070	1.2	✓
60065	12	-



**Solar Cell for Autonomous Solar Powered Fan**

Code | 60069

Plumbing & Ventilation

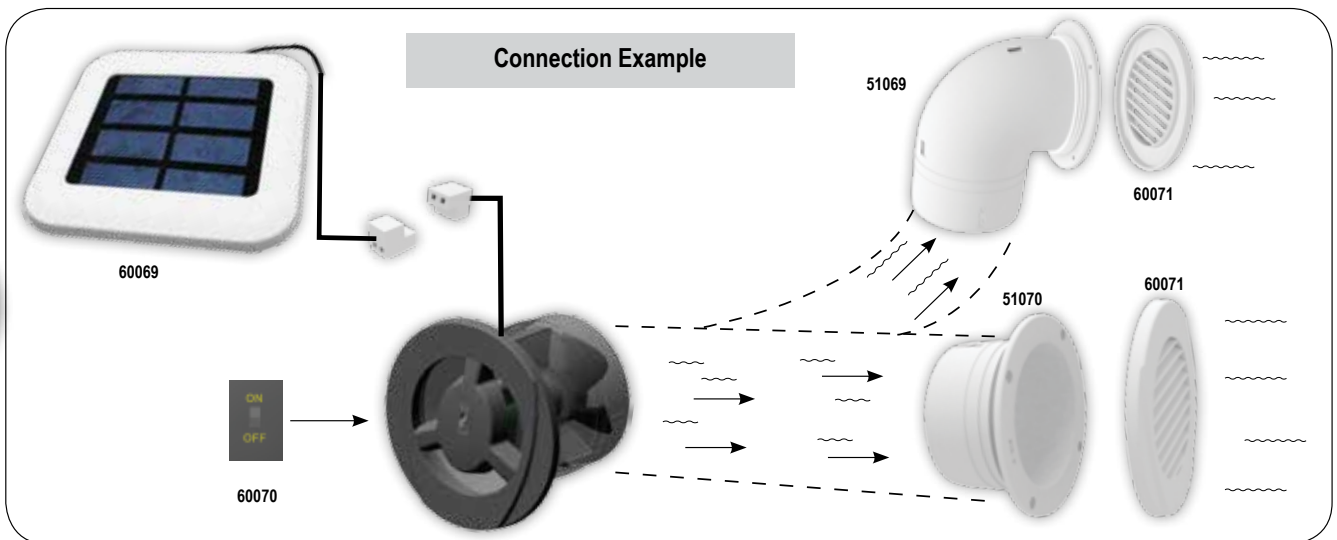

## Ventilators "EVO"

"EVO" ventilators achieve natural air circulation in the interior of your boat. They improve air quality, reduce humidity and eliminate carbon dioxide concentration indoors. Healthy atmosphere relaxes the crew and prolongs electrical devices life. "EVO" ventilators 70231 and 70235 are made of polypropylene and 70234 and 70238 are made of ABS. They come in rectangular and square shape and they can be combined with connector 70239 for better performance.



Code	Dimensions (mm)	Material	Colour
70235	91.5x91.5x16.5	Polypropylene	White
70238		ABS	Chrome

Code	Dimensions (mm)	Material	Colour
70231	183x91.5x16.5	Polypropylene	White
70234		ABS	Chrome



## Connector "EVO"

"EVO" connector is attached on ventilators to support the bulkhead of your boat. The advantage of this connector is its unique design, which prevents heavy water inflows in rough sailing. "EVO" connector is made of polypropylene and comes in white colour.



Code	Dimensions (mm)	Material	Colour
70239	80 x 80 x 65	Polypropylene	White





“24 hours” Vent

“24 hours” vent is completely automatic as it works with solar energy in sunny days and batteries, during night time. Forced ventilation is controlled through a dynamic impeller which turns clockwise to inflow and counter clockwise to exhaust air. The user adjusts the vent on the corresponding function through on/off switches. Active air movement absorbs moisture and refreshes the interior of your boat completely. Simultaneously, when water enters the vent special balls inside, it blocks its entry to achieve absolute impermeability. “24 hours” vents are made of white plastic. The vent 99689 is equipped with Inox plated cover.

**Battery**

Rechargeable battery, charged automatically by the solar panel. Activation with on/off switches.



**PCB**

Three functions PCB to activate solar function, activate battery function and modify fan function from clockwise to counter clockwise turn.

**Solar panel**

Operates with Solar Energy. Activation with on/off switches



**Impermeability**

Water pushes the special balls inside the vent to shut ventilation holes and ensure absolute impermeability



Code	Diameter (cm)	Cut Area (cm)	Cover
99688	20	9,5	White
99689			Inox Plated

Solar Vent

Solar vents provide mechanical ventilation utilizing the solar energy. The solar panel activates the fan which allows the air to flow in. These autonomous vents detect water flows from waves and rain, while refreshing the atmosphere even on those calm windless days. Special balls inside the vents are pushed by the water to shut ventilation holes and ensure impermeability. They have two functions; one function activates solar function and the other one modifies fan's function from clockwise to counter clockwise turn. Solar vents are made of white plastic, while the 98681 vent is equipped with an Inox plated cover.

**Solar panel**

Operates with Solar Energy. Activation with on/off switches



**Impermeability**

Water pushes the special balls inside the vent to shut ventilation holes and ensure absolute impermeability



Code	Diameter (cm)	Cut Area (cm)	Cover
98680	20	9,5	White
98681			Inox Plated

Cabin Vent

Cabin vents offer natural ventilation indoors and prevent water leaks from waves and rain. They open and close manually. When open, air is circulated and water stays out of your boat. Cabin vents are made of plastic. The vent 98621 is equipped with Inox plated cover.

**Impermeability**

Water pushes the special balls inside the vent to shut ventilation holes and ensure absolute impermeability



Code	Diameter (cm)	Cut Area (cm)	Cover
70158	20	9,5	White
98621			Inox Plated



**Ventilator, Inox 316**

It opens and closes.



Code	Diameter (mm)	Thickness (mm)
99808	125	0,8

**Louver Ventilator, Inox 316**



Code	Diameter (mm)	Thickness (mm)
99810	102	0,8
99809	126	

**Ventilators**

Made of strong ABS, it is certain that these ventilators will remain on your boat for a very long time. There are two sizes available, with dimensions 115mm x 127,5mm and 90mm x 255mm respectively. Mounting is very easy since they have been designed to be integrated into the walls of the boat and secured with screws.



Code	01685	01686
Colour	White	
Dimensions (cm)	11,5X12,7	9X25,5



## Ventillation



### Louver Ventilator, Inox

Code	Length (mm)	Width (mm)	Height (mm)
99067	325	76	27
99068	525	76	27



### Louver Ventilator, Inox

Code	Length (mm)	Width (mm)	Height (mm)
99062	205	112	27
99066	325	112	27



### Clam Shell Ventilator, Inox 304

Code	Length (mm)	Width (mm)	Height (mm)
99061	132	117	53
99060	150	145	57
99059	175	170	72

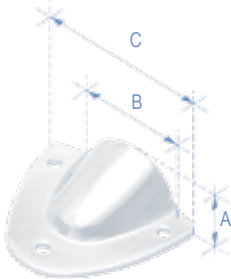

### Vent, Inox 316

Surface: E.P\*, Body: Forging

Code	92790	92789
A(mm)	11	16
B(mm)	27	50
C(mm)	42,2	62,50

\*E.P.= Electro polished



### Louver Ventilator, Inox 316

Code	Length (mm)	Width (mm)	Thickness (mm)
99063	127	115	0,8
99064	230	127	
99065	228	127	

### Low Profile Flexible Ventilator

Code	99695	99696	99697	99698
Internal Diam. (mm)	77	95	77	95
Dimensions (mm)	165x140x80	200x155x120	120x100x225	140x140x225



## Strainers

### In-line Strainer with Stainless Steel Mesh Filter

Plastic body with clear acrylic cap



Code	Inlet & Outlet Diameter	Type Inlet/Outlet	Mesh Type
99755	Ø 19mm (3/4")	Hose	Large
99756	Ø 12mm (1/2")	Hose	Large
99757	Ø 12mm (1/2")	Pipe	Fine



### Raw Water Strainer with Mesh Filter

PP body and mesh with clear acrylic cap

Code	Inlet & Outlet Diameter	Dimensions (mm)	Type Inlet/Outlet	Capacity (L)
99758	Ø 12mm (1/2")	142x135	Hose	0,5
99759	Ø 16mm (5/8")		Hose	
99760	Ø 19mm (3/4")		Hose	
99761	Ø 25mm (1")	192,5x179	Hose	1,5
99762	Ø 32mm (1 1/4")		Hose	
99763	Ø 38mm (1 1/2")		Hose	



### Plastic Strainer Grilled



#### Features:

- Shock resistant polyamide
- Dimensions: 120 x 80
- Oval
- Black

Code | 16712



### Plastic Bilge Strainer

#### Features:

- For hoses with Ø18/20/24
- Output horizontal
- Dimensions: 145 x 60 x 38 mm
- Shape rectangular
- Black

Code	Colour	Hose Ø (mm)	Output	Shape	Dimensions (mm)
13942	Black	18/20/24	Horizontal	Rectangular	145x60x38

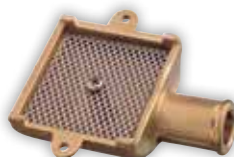
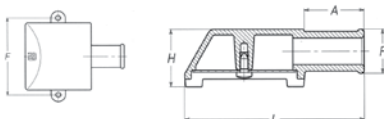

### Bilge Strum Box with Inox Gauze

Code	Weight (gr)	F	L	H	A	P
90293	170	64	82	25	27	20
90294	400	89	110	30	30	25



# Electrical Equipment



From the simplest to the most complex electrical installation on a boat, a proper study on how to make the connections with efficiency and safety is essential. Why not taking advantage of the renewable energy by using solar panels to maintain and charge the batteries? You can also use AquaLED lights with lower consumption yet better lighting!

At MARINA Stores, you can find top-quality products for all your needs on board, so that every trip gives you unique moments of relaxation and tranquility, whether you are anchored in the marina or at your favourite beach!

<b>LED Navigation Lights</b> _____	<b>314-322</b>	<b>Bus Bars &amp; Terminal Blocks</b> _____	<b>339</b>
<b>Standard Navigation Lights</b> _____	<b>322-330</b>	<b>Switches</b> _____	<b>339-340</b>
<b>LED Utility Lights</b> _____	<b>331-333</b>	<b>Power Shore Plugs &amp; Sockets</b> _____	<b>340-342</b>
<b>Spotlights</b> _____	<b>333</b>	<b>Solar Panels</b> _____	<b>342-343</b>
<b>Flashlights</b> _____	<b>333</b>	<b>Inverters</b> _____	<b>343</b>
<b>Marine Cables &amp; Accessories</b> _____	<b>334</b>	<b>Battery Accessories</b> _____	<b>344-345</b>
<b>Cable Terminals</b> _____	<b>334-335</b>	<b>Battery Switches</b> _____	<b>345</b>
<b>Switch Panels &amp; Accessories</b> _____	<b>335-338</b>	<b>Marine Speakers</b> _____	<b>346</b>
<b>Fuses &amp; Accessories</b> _____	<b>338-339</b>	<b>Replacement Bulbs</b> _____	<b>346-347</b>

**new**



**MICRO LED Pole Light**

According to the COLREG 72, all pole lights should be placed higher than sidelights. Thus, it is easier for other boats to calculate their position in relation to your position and direction. Furthermore, a light positioned lower may be obscured by other objects or people. LALIZAS MICRO LED range of Pole Lights includes folding and plug in options, meeting all possible requirements by demanding boaters. This innovative and elegant type of pole lights may be used on boats less than 12m as a white all-round stern light.

**Material:** Made of anodised aluminium tubing with polycarbonate lens and a glass reinforced nylon base.

**Housing:** Available in grey and black housing.

**Visible distance:** 1nm : 12/24V & 0.25W.

**Installation:** Pole lights are positioned in such a way that they are higher than the sidelights and may be screwed into position. Depending on the model, you can adjust the height of the light. Two lengths of LALIZAS Pole Lights are available: 25 & 60cm.

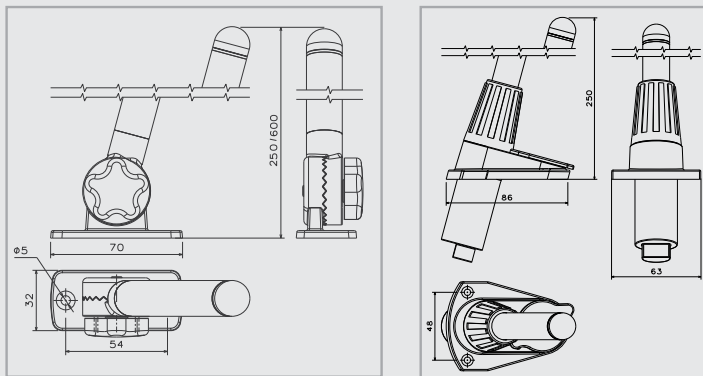

**MICRO LED**

Code	74364	74363	74366	74365	74382	74381	74384	74383
Base	Folding		Plug in		Folding		Plug in	
Length (cm)	25	60	25	60	25	60	25	60
Housing	Grey				Black			

Electrical Equipment

For boats up to 12m



**MICRO LED**

**new**

**MICRO LED 12 Starboard & Port Lights 112,5°, Side & Flush mounted, Set**

MICRO LED series includes the smallest but brightest navigation lights to indicate your position & keep you safe on the water. With elegant design and easy installation with just one hole, these lights provide the smallest possible "footprint" that a navigation light can leave on a boat. Their housing come in three different colours (white, black and chrome). There are two different options in terms of fastening (with screws or with silicone).

- Side & flush mounted
- Modern design
- Waterproof
- Non-corrosive
- Non-magnetic
- Easy installation
- CE certified

**Characteristics:**

- Material: White ASA housing & shatterproof PC lens
- Visible distance (Starboard – Port): 1 nm
- Power consumption: 0.25 W, on 12/24 V

**Included:**

Self-adhesive EVA flange & Wire length 150 mm & \*Screws-DIN7982 ST2 9x13 (\*for mounting with holes).

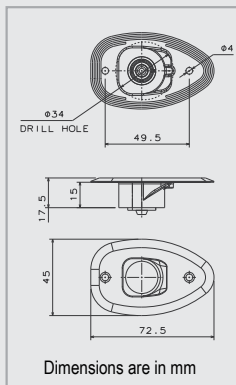

Code	74357	74359	74361
Mounting	without holes (with glue)		
Housing	White	Black	Chrome

Code	74358	74360	74362
Mounting	with holes (screws)		
Housing	White	Black	Chrome

**Installation:**

MICRO LED Lights are a unique design within LALIZAS range of side & flush mounted navigation lights. They can be easily positioned into the boat's bow with just one hole. Depending on the product code, they can be fastened either with silicone or with screws, without leaving any sharp edges to spoil the boat's lines or cause injuries.



Meet the requirements for:  
COLREG 72 / MSC 253(83) / IEC 60945:2002 / EN 14744:2005 / ABYC A-16.1997 / IP67 & USCG Approval

FOS LED series of navigation lights are designed to save power consumption on board and offer reliability, efficiency and optimal visibility at sea. This series of LED navigation lights is suitable for boats up to 20m (depending on the product code) for enhanced safety. LED technology provides supreme efficiency with up to 80% less power consumption compared to conventional bulbs. Their completely sealed unit ensures durability and safety.

## FOS LED 12 Starboard & Port Lights 112,5°, Set

- For boats up to 12 m
- Visible distance: 1 nm
- 12-15V DC & 0.5W
- Red & green LED light
- Side mounted
- Lasts for 50.000 hours
- Waterproof, non-corrosive, non-magnetic
- Weight: 65gr/pc

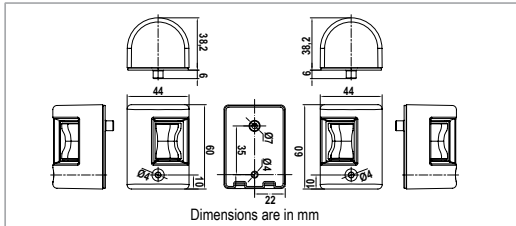

FOS LED

For boats up to 12m



71299

71300

Included:

1. Screws DIN7981 / ISO 7049 M3.5x32mm
2. Wire length 0.6m
3. Double-side adhesive sticker that can be used as drilling drawing

Code	71299	71300
Housing	Black	White

## FOS LED 12 Stern Light, 135°

- For boats up to 12 m
- Visible distance: 2 nm
- 12-15V DC & 0.5W
- White LED light
- Side mounted
- Lasts for 50.000 hours
- Waterproof, non-corrosive, non-magnetic
- Weight: 65gr/pc

Included:

1. Screw DIN7981 / ISO 7049 M3.5x32mm
2. Wire length 0.6m
3. Double-side adhesive sticker that can be used as drilling drawing

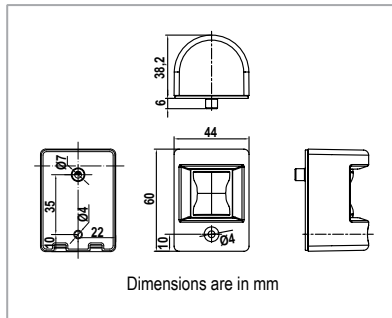

71301

71302



Code	71301	71302
Housing	Black	White

## FOS LED 12 Masthead Light 225°

- For boats up to 12 m
- Visible distance: 2 nm
- 12-15V DC & 1W
- White LED light
- Side mounted
- Lasts for 50.000 hours
- Waterproof, non-corrosive, non-magnetic
- Weight: 150gr/pc

Included:

1. Screw DIN7981 / ISO 7049 M3.5x32mm
2. Wire length 0.6m
3. Double-side adhesive sticker that can be used as drilling drawing

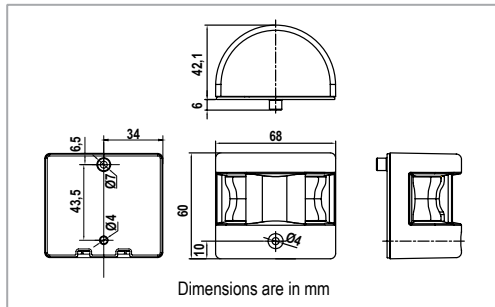

71303

71304



Code	71303	71304
Housing	Black	White

### Combine with

Tinned Marine Cables  
page 334

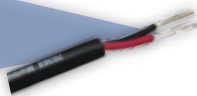

## FOS LED 12 Bi-colour Light

- For boats up to 12 m
- Visible distance: 1 nm
- 12-15V DC & 1W
- Red & green LED light
- Side mounted
- Lasts for 50.000 hours
- Waterproof, non-corrosive, non-magnetic
- Weight: 150gr/pc

Included:

1. Screw DIN7981 / ISO 7049 M3.5x32mm
2. Wire length 0.6m
3. Double-side adhesive sticker that can be used as drilling drawing

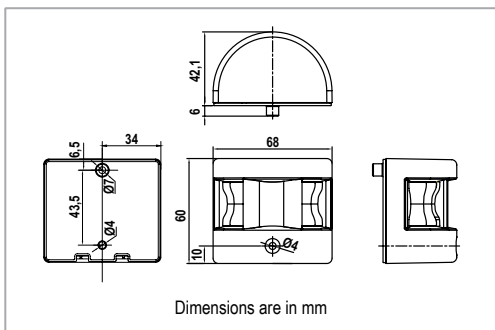

71306

71305



Code	71305	71306
Housing	Black	White

Electrical Equipment



For boats up to 12m



FOSLED



71315



71316

## FOS LED 12 Starboard & Port Lights 112,5°, Set

- For boats up to 12 m
- Visible distance: 1 nm
- 12-15V DC & 0.5W
- Red & green LED light
- Side & flush mounted
- Lasts for 50.000 hours
- Waterproof, non-corrosive, non-magnetic
- Weight: 75gr/pc



Included:

1. Screws DIN7981 / ISO 7049 M3.5x13mm
2. Wire length 0.6m
3. Double-side adhesive sticker that can be used

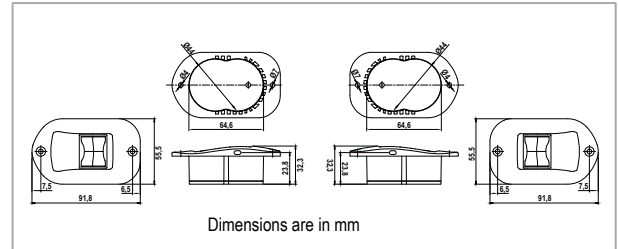

Code	71315	71316
Housing	Black	White



71313

Code	71313	71314
Housing	Black	White



71314

## FOS LED 12 Starboard & Port Lights 112,5°, Set

- For boats up to 12 m
- Visible distance: 1 nm
- 12-15V DC & 0.5W
- Red & green LED light
- Side mounted
- Lasts for 50.000 hours
- Waterproof, non-corrosive, non-magnetic
- Weight: 60gr/pc

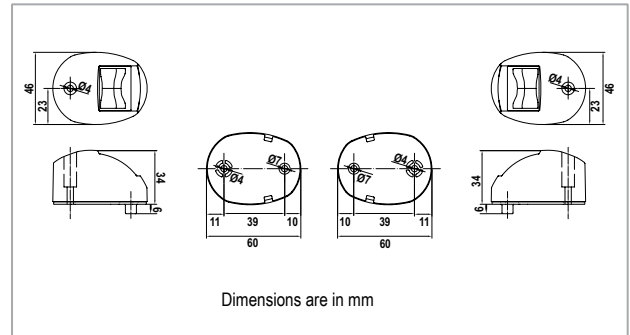

Included:

1. Screws DIN7981 / ISO 7049 M3.5x32mm
2. Wire length 0.6m
3. Double-side adhesive sticker that can be used as drilling drawing

Combine with  
Tinned Marine Cables  
page 334



71317



71318

## FOS LED 12 Starboard & Port Lights 112,5°, Set

- For boats up to 12 m
- Visible distance: 1 nm
- 12-15V DC & 0.5W
- Red & green LED light
- Deck mounted
- Lasts for 50.000 hours
- Waterproof, non-corrosive, non-magnetic
- Weight: 60gr/pc

Included:

1. Screws DIN7981 / ISO 7049 M3.5x32mm
2. Wire length 0.6m
3. Double-side adhesive sticker that can be used as drilling drawing

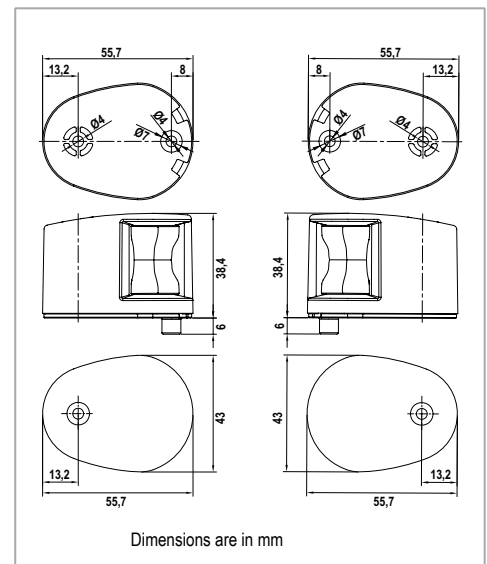

Code	71317	71318
Housing	Black	White



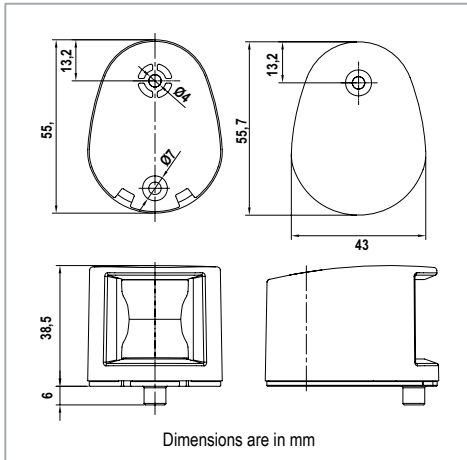

### FOS LED 12 Stern Light 135°

- For boats up to 12 m
- Visible distance: 2 nm
- 12-15V DC & 0.5W
- White LED light
- Deck mounted
- Lasts for 50.000 hours
- Waterproof, non-corrosive, non-magnetic
- Weight: 55gr/pc

**Included:**

1. Screw DIN7981 / ISO 7049 M3.5x32mm
2. Wire length 0.6m
3. Double-side adhesive sticker that can be used as drilling drawing



Code	71319	71320
Housing	Black	White

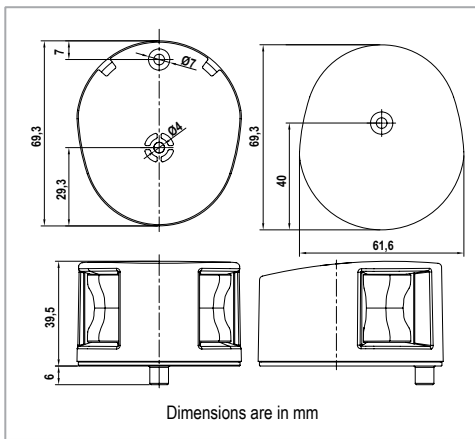

### FOS LED 12 Bi-colour Light

- For boats up to 12 m
- Visible distance: 1 nm
- 12-15V DC & 1W
- Red & green LED light
- Deck mounted
- Lasts for 50.000 hours
- Waterproof, non-corrosive, non-magnetic
- Weight: 90gr/pc

**Included:**

1. Screw DIN7981 / ISO 7049 M3.5x32mm
2. Wire length 0.6m
3. Double-side adhesive sticker that can be used as drilling drawing



Code	71321	71322
Housing	Black	White

**Combine with**  
Tinned Marine Cables  
page 334

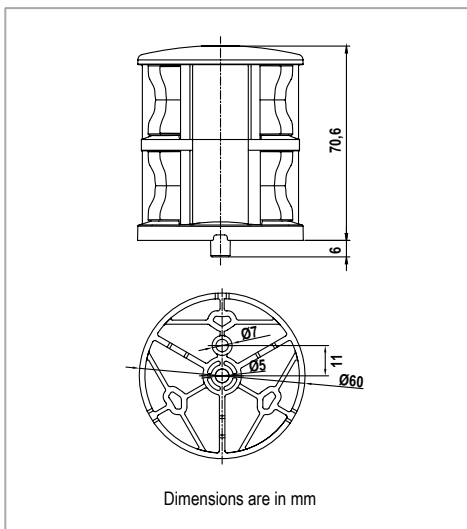
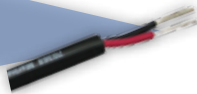

### FOS LED 12 Tri-colour & Anchor Light

- For boats up to 12 m
- Visible distance: 1+1+2 nm & anchor light 2 nm
- 12-15V DC & 3W
- Red, green & white LED light
- Deck mounted
- Lasts for 50.000 hours
- Waterproof, non-corrosive, non-magnetic
- Weight: 160gr/pc

**Included:**

1. Screw DIN7981 / ISO 7049 M4,8x60mm
2. Wire length 0.6m,
3. Double-side adhesive sticker that can be used as drilling drawing



Code	71311	71312
Housing	Black	White

Electrical Equipment



For boats up to 12m



**FOSLED**



71309

71310

Code	71309	71310
Housing	Black	White

## FOS LED 12 Tri-colour Light

- For boats up to 12m
- Visible distance: 1+1+2 nm
- 12-15V DC & 1,5W
- Red, green & white LED light
- Deck mounted
- Lasts for 50.000 hours
- Waterproof, non-corrosive, non-magnetic
- Weight: 95gr/pc

### Included:

1. Screw DIN7981 / ISO 7049 M3.5x32mm
2. Wire length 0.6m
3. Double-side adhesive sticker that can be used as drilling drawing

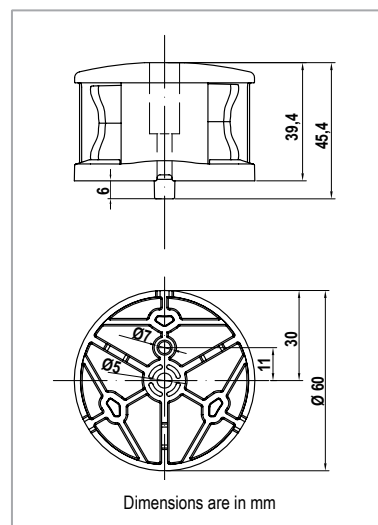

For boats up to 20m



**FOSLED**



71307

71308

Code	71307	71308
Housing	Black	White

## FOS LED 20 All-round Light 360°

- For boats up to 20 m
- Visible distance: 2 nm
- 12/24V DC & 1,5W
- White LED light
- Deck mounted
- Lasts for 50.000 hours
- Waterproof, non-corrosive, non-magnetic
- Weight: 95gr/pc

### Included:

1. Screw DIN7981 / ISO 7049 M3.5x32mm
2. Wire length 0.6m
3. Double-side adhesive sticker that can be used as drilling drawing

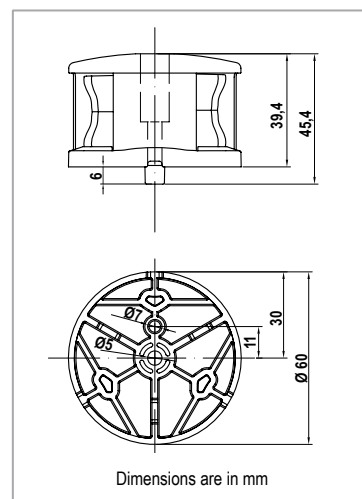

Electrical Equipment



**Combine with**  
Tinned Marine Cables  
page 334

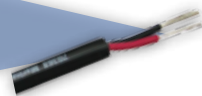

## FOS LED 20 Stern Light 135°

- For boats up to 20 m
- Visible distance: 2 nm
- 12/24 V DC & 1.5 W
- White LED light

- Side mounted
- Lasts for 50,000 hours
- Waterproof, non-corrosive, non-magnetic
- Weight: 165gr/pc



71970

71971

Code	71970	71971
Housing	Black	White

### Included:

1. Screw DIN7981 / ISO 7049 M4.2x32mm (2 pieces per item)
2. 1.2m length of wire per product
3. Double-side adhesive sticker that can be used as drilling drawing

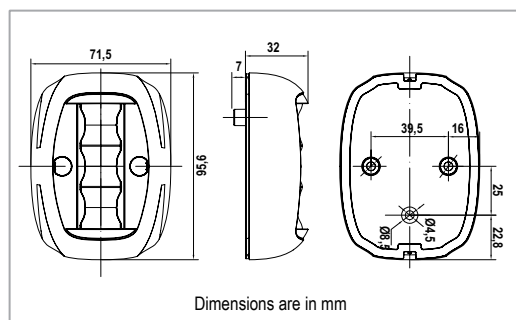





For boats up to 20m

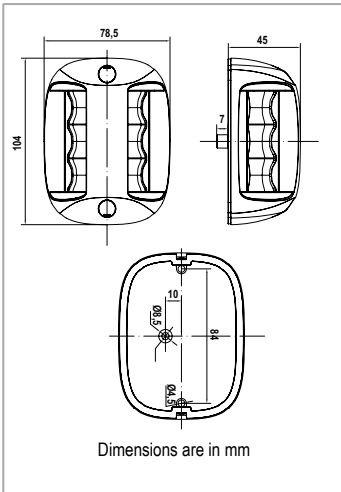

**FOS LED 20 Masthead Light 225°**

- For boats up to 20 m
- Visible distance: 2 nm
- 12/24V DC & 3W
- White LED light
- Side mounted
- Lasts for 50.000 hours
- Waterproof, non-corrosive, non-magnetic
- Weight: 235gr/pc

**Included:**

1. Screw DIN7981 / ISO 7049 M4.2x32mm (2 pieces per item)
2. 1.2m length of wire per product
3. Double-side adhesive sticker that can be used as drilling drawing



71972

71973



Code	71972	71973
Housing	Black	White

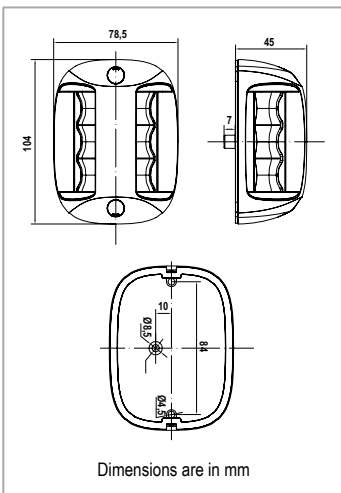

**FOS LED 20 Bi-colour Light**

- For boats up to 20 m
- Visible distance: 2 nm
- 12/24 V DC & 3W
- Red & green LED light
- Side mounted
- Lasts for 50.000 hours
- Waterproof, non-corrosive, non-magnetic
- Weight: 235gr/pc

**Included:**

1. Screw DIN7981 / ISO 7049 M4.2x32mm (2 pieces per item)
2. 1.2m length of wire per product
3. Double-side adhesive sticker that can be used as drilling drawing

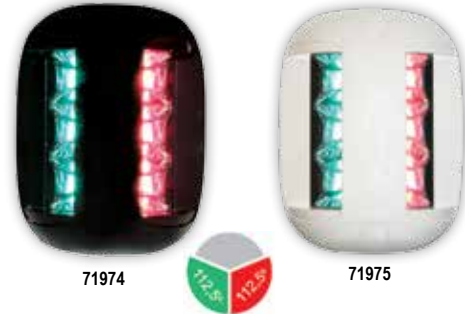

71974

71975



Code	71974	71975
Housing	Black	White

Electrical Equipment

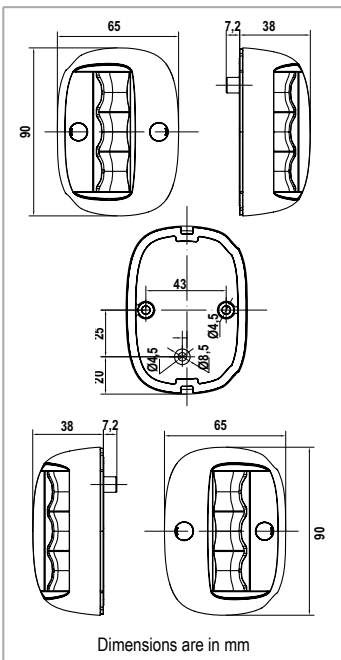

**FOS LED 20 Starboard & Port Lights 112.5°, Set**

- For boats up to 20 m
- Visible distance: 2 nm
- 12/24 V DC & 1.5 W
- Green & red LED light
- Side mounted
- Lasts for 50.000 hours
- Waterproof, non-corrosive, non-magnetic
- Weight: 155gr/pc

**Included:**

1. Screw DIN7981 / ISO 7049 M4.2x32mm (2 pieces per item, total 4 pieces)
2. 1.2 m length of wire per product
3. Double-side adhesive sticker that can be used as drilling drawing



71968

71969

Code	71968	71969
Housing	Black	White

**Combine with**  
Tinned Marine Cables  
page 334



Meet the requirements for: COLREG 72 / MSC 253(83) / EN 14744:2005

Classic LED series of navigation lights are designed for boats up to 20m (depending on the product code). Made of tough UV stabilized ABS polycarbonate compound with shatter-proof acrylic lens, stainless steel electrical contacts and nitrile water resistant seal to provide reliable long-life. All CLASSIC LED are supplied with encapsulated in silicon 12/24V LED bulb to ensure maximum energy saving, protection against humidity and a long lifetime of 50.000 hours.

For boats up to 12m



## CLASSIC LED

Combine with  
Tinned Marine Cables  
page 334

### CLASSIC LED 12 All-round Lights

All round lights are screw mounted on the mast as high as possible and are connected to the central or auxiliary circuit.



72164



72167



- For boats up to 12 m
- Visible distance: 2 nm
- 12/24V DC & 2 W
- White LED light or tri-colour
- Deck mounted
- Waterproof, non-corrosive, non-magnetic

Code	72164	72167
Description	White	Tri-colour
Housing	Black	

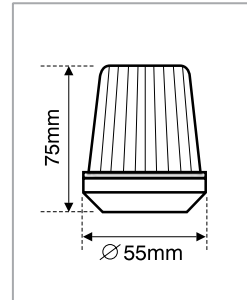

### CLASSIC LED 12 Bulb (BA15S) for All-round Lights 12/24V

Code | 72182

### CLASSIC LED 12 Starboard - Port - Stern - Masthead - Bi-colour Light

Electrical Equipment



72168



72169



72170



72171



72172



- For boats up to 12 m
- Visible distance:
- Port - Starboard - Bi-colour: 1 nm
- Stern - Masthead: 2 nm
- 12/24V DC & 2 W
- Side mounted
- Waterproof, non-corrosive, non-magnetic

Code	72168	72169	72170	72171	72172
Description	Starboard Green 112,5°	Port Red 112,5°	Stern White 135°	Masthead White 225°	Bi-colour 225°
Housing	Black				

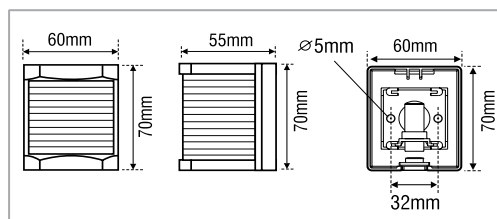

### CLASSIC LED Bulb Kit 12, 12/24V

Code | 72183

For boats up to 20m



## CLASSIC LED



72176



72173



### CLASSIC LED 20 All-round Light

- For boats up to 20 m
- Visible distance: 2 nm
- 12/24V DC & 4 W
- Deck mounted
- Waterproof, non-corrosive, non-magnetic

Code	72176	72173
Description	Signal White 360°	Tricolour 360°
Housing	Black	

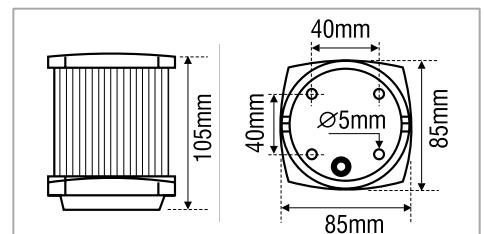

### CLASSIC LED 20 Bulb (BAY15D), 12/24V

Code | 72184



**CLASSIC LED**

For boats up to 20m

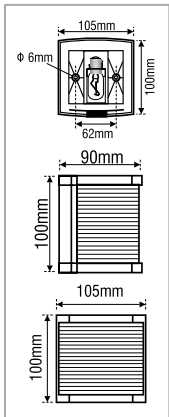

**CLASSIC LED 20 Starboard - Port - Stern - Masthead - Bi-colour Light**



**CLASSIC LED 20 Bulb (BAY15D), 12/24V**  
Code | 72184

Code	72177	72178	72179	72180	72181
Description	Starboard Green 112,5°	Port Red 112,5°	Stern White 135°	Masthead White 225°	Bi-colour 225°
Housing	Black				

- For boats up to 20 m
- Visible distance:
- Port - Starboard - Bi-colour: 2 nm
- Stern: 2 nm
- Masthead: 3 nm
- 12/24V DC & 4W
- Side mounted
- Waterproof, non-corrosive, non-magnetic

**CLASSIC LED 20 All-round & Tri-colour Light**

This all-round (white) & tri-colour navigation light features an improved bulb holder, simplified wiring installation and compact two-piece design. This is one compact product with protection against electrolysis, easier and more effective electric connection.

- For boats up to 20 m
- Visible distance:
- All around: 2 nm
- Tri-colour: 2 nm
- 12/24V DC & 4W/ each light
- Deck mounted
- Waterproof, non-corrosive, non-magnetic

To change the bulb follow the instructions as indicated in the pictures.

UnscREW the casing by turning it anti-clockwise

Pull the casing and change the bulbs needed

Place the casing by matching the lugs to the relevant slots and turning clockwise

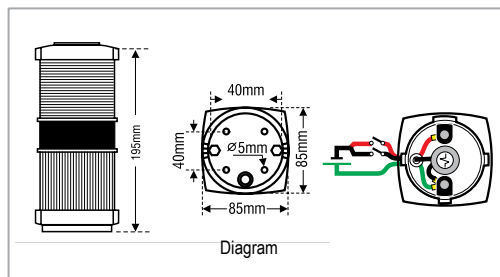

Code | 72189

Electrical Equipment

CLASSIC LED 20 Bulb (BAY15D), 12/24V



Code | 72184

**CLASSIC LED**

**LED KITS**

“LED UP” your CLASSIC 12 & 20 Navigation Lights

**CLASSIC LED 12 Bulb (BA15S) for All-round Lights 12/24V**  
Code | 72182

**LED IT UP**

**All-round Light, White 360°**  
Code | 30111

**All-round Light, Tri-colour 360°**  
Code | 30114

**CLASSIC LED**

**LED KITS**

**"LED UP" your CLASSIC 12 & 20 Navigation Lights**



LED IT UP

**CLASSIC LED 12 Bulb Kit, 12/24V**

Code | 72183

**CLASSIC 12 Navigation Lights**



**Starboard Light 112,5°**

Code | 30091



**Port Light 112,5°**

Code | 30092



**Stern Light 135°**

Code | 30093



**Masthead Light 225°**

Code | 30094



**Bi-colour Light 225°**

Code | 30095

**CLASSIC 20 Navigation Lights**



LED IT UP

**CLASSIC LED 20 Bulb (BAY15D), 12/24V**

Code | 72184



**Starboard Light 112,5°**

Code | 30501



**Port Light 112,5°**

Code | 30502



**All-round Light, White 360°**

Code | 30523



**All-round & Tri-colour Light 360°**

Code | 30415



**Stern Light 135°**

Code | 30503



**Masthead Light 225°**

Code | 30504



**Bi-colour Light 225°**

Code | 30505



**All-round Light, Tri-colour 360°**

Code | 30404

Electrical Equipment

**Flexy**  
Emergency  
NavLights

- 3NM visibility
- 12 hours' battery life
- Easy set up
- Water-resistant

Suitable for sailboats, fishing boats, inflatable tender boats, kayaks, diving buoys.

**LALIZAS FLEXY EMERGENCY NavLights, Set of 3pcs**



Code | 72663

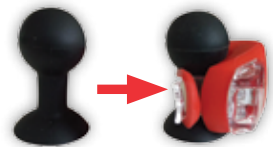

**Suction Base for LALIZAS FLEXY EMERGENCY**

Code | 72665

**Standard Navigation Lights**



**EMERGENCY Navigation Lights**

EMERGENCY waterproof navigation lights are ideal for use on small crafts, inflatable boats, kayaks, or as emergency lighting in larger boats.

All portable emergency lights can be used when conventional lights are not suitable for the vessel or when they are not operating. They are available with external light reflectors. Standard alkaline batteries (D cell) are needed (not included), giving approx. 9 hours of continuous use.

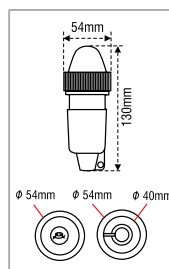

Code	30001	30002	30003	30010
Description	Green	Red	White	Set



**Bulb in blister 1,1 V/0,33 w, E10, C6U**

Code | 30640



**Bulb 1,1 V/0,33 W, E10, C6U**

Code | 00453



## Pole Light

According to the COLREG 72, all pole lights should be placed higher than the sidelights. Thus, it is easier for other boats to calculate their position in relation to your position and direction. Furthermore, a light positioned lower may be obscured by other objects or people. LALIZAS range of Pole Lights includes telescopic, folding and plug in options, thus meeting all requirements. This type of pole lights may be used on sailing boats less than 20m (tri-colour) or on powerboats less than 12m (white), instead of small all-round lights. **Material:** Made of marine grade stainless steel 304 tubing with ABS plastic, polycarbonate lens and nitrite O ring sealed light and a fibre nylon mix base. **Housing:** Available in black and white. **Installation:** Pole lights are positioned in such a way that they are higher than the sidelights and may be screwed into position. Depending on the model, you can adjust the height of the light. Five lengths of LALIZAS Pole Lights are available in five different lengths which vary between 23cm and 130cm. **Visible distance:** 2nm. **Bulb (included):** 12V / 10W.

### Pole Lights with black housing

Housing	Telescopic		Plug in		Folding	
Base						
Length	54 cm	54 cm	105 cm	130 cm	23 cm	64 cm
Code	30143	30163	30243	30263	30173	30153

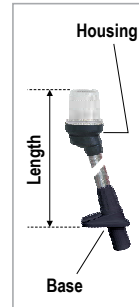

### Pole Lights, Tri-colour with black housing

Housing	Plug in	Folding	
Base			
Length	54 cm	23 cm	64 cm
Code	30234	30214	30204

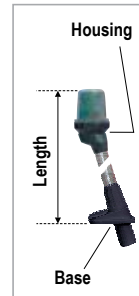

### Pole Lights with white housing

Housing	Telescopic		Plug in		Folding	
Base						
Length	54 cm	54 cm	105 cm	130 cm	23 cm	64 cm
Code	30273	30293	30333	30353	30763	30283

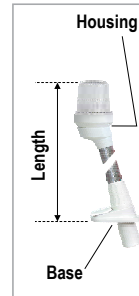

### Pole Lights, Tri-colour with white housing

Housing	Plug in	Folding	
Base			
Length	54 cm	23 cm	64 cm
Code	30324	30784	30774

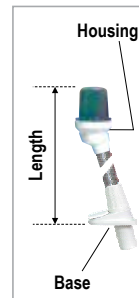

Electrical Equipment



Bulb in blister  
12V/10W, BA15S,  
C2R

Code | 30630



Bulb LED, 12V,  
T18 BA15S, Cool White  
- 18 LEDs

Code | 71228



Bulb 12V/10W,  
BA15S, C2R

Code | 00420



CLASSIC LED 12 Bulb  
(BA15S) for All-round  
Lights, 12/24V DC

Code | 72182

### Base for plug in light

Code	31020	31030
Colour	Black	White



# Standard Navigation Lights

For boats up to 7m



**LALIZAS**



**EASY MOUNTING**

## FAROS 7

FAROS 7 series of navigation lights include masthead, starboard, port and stern lights, ideal for powerboats up to 7m. They are waterproof, non-corrosive and non-magnetic. **Material:** Made of nylon fiber mix housing and shatterproof plexiglass (PMMA) lens. **Housing:** Available in black housing. **Seal:** Nitrile water resistant. **Installation:** Side & deck mounted. They are mounted on the surfaces with wall plugs. Navigation lights with wall plug have the advantage that they are much easier to mount and you only need to open one hole. This range is provided with a two sided adhesive tape and flange, which by sticking it on the surface you know exactly where to open the hole and the flange is already in the correct place. **Visible distance:** Port - Starboard - Bi-colour: 1nm / Stern - Masthead: 2nm. **Contacts:** Brass. **Bulb (included):** 12V / 5W



### Masthead Light 225°

Code	30864
Housing	Black



### Bi-colour Light 225°

Code	30865
Housing	Black



### Starboard Light 112,5°

Code	31051
Housing	Black



### Port Light 112,5°

Code	31052
Housing	Black

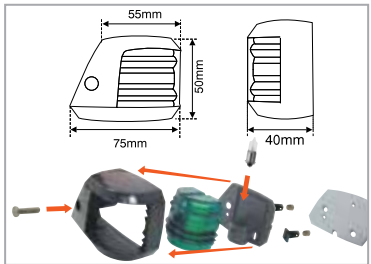

### Starboard Light 112,5°

Code	30861
Housing	Black



### Port Light 112,5°

Code	30862
Housing	Black

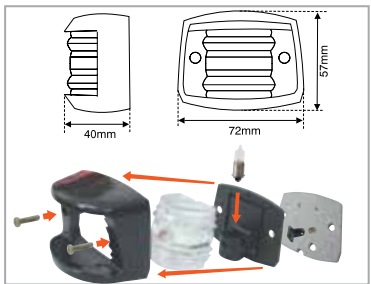

### Stern Light 135°

Code	30863
Housing	Black



**Combine with**  
Tinned Marine Cables  
page 334

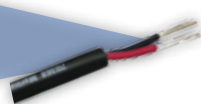

**Bulb in blister 12V/5W, BA9S, C2R**

Code	30940
------	-------



**Bulb 12V/5W, BA9S, C2R**

Code	01184
------	-------



**Bulb LED, 12V, BA9S, Cool White - 4SMDs + 1LED**

Code	71233
------	-------



1 Remove the protective paper from the self adhesive flange



2 Attach the flange at the point you want to place the light and open the holes using a drill



3 Pass the wires through the lower hole and fit the light's raw plugs in the side holes



4 Screw until the raw plugs are secured



For boats up to 7m



## MATI 7

MATI 7 series of navigation lights are designed for powerboats up to 7m length. They are waterproof, non-corrosive and non-magnetic. **Material:** Nylon fiber mix housing. Shatterproof Plexiglas (PMMA) lens. **Housing:** Available in black, white and chrome housing. **Seal:** Nitrile water resistant. **Installation:** MATI 7 lights have a unique design within the LALIZAS range of side mounted navigation lights. Their special design enables them to be neatly mounted on the boat with safety and without compromising on appearance. They are fitted into the boat's bow, without leaving any sharp edges to either spoil the boat's lines or cause any injuries. They are provided with a two sided adhesive tape and flange, which by sticking it on the surface you know exactly where to open the hole and the flange is already in the correct place. **Visible distance:** Port - Starboard: 1nm / Stern: 2nm. Contacts: Brass. **Bulb (included):** 12V / 5W.



### MATI 7 Starboard & Port - Stern Lights



30841



30842



30851



30852



30921



30922



30843



30853

#### Starboard Light 112,5°

Code	30841	30851	30921
Housing	Black	White	Chrome

#### Port Light 112,5°

Code	30842	30852	30922
Housing	Black	White	Chrome

#### Stern Light 135°

Code	30843	30853
Housing	Black	White

Electrical Equipment

**Combine with**  
Tinned Marine Cables  
page 334

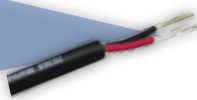

**Bulb in blister**  
12V/5W, BA9S, C2R

Code | 30940



**Bulb 12V/5W,**  
BA9S, C2R

Code | 01184



**Bulb LED, 12V, BA9S,**  
Cool White - 4SMDs  
+ 1LED

Code | 71233

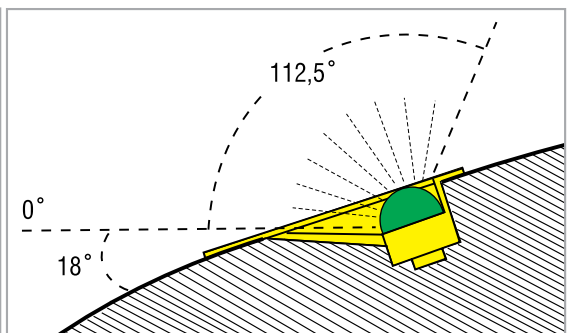
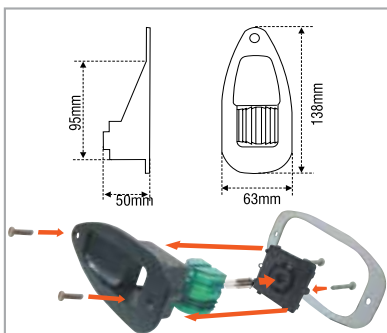
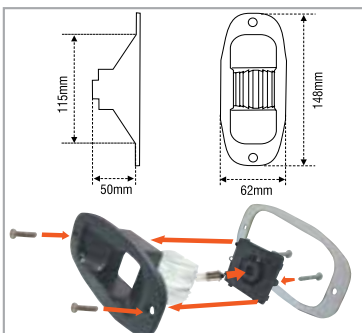

# Standard Navigation Lights

For boats up to 7m



## POWER 7

POWER 7 series of power boat navigation lights is compact and streamlined to follow comfortably the fit of most boats. **Material:** The lenses are made of tough polycarbonate with nylon fibre mix housing and stainless internal components for added strength. **Housing:** Available in black and white housing. **Installation:** Bi-colour and masthead lights are available for side and deck mounting. They are fixed through the base with two or more screws, and the housing is clipped on. Their round shape is less likely to snag with other fittings or ropes. Visible distance: Port - Starboard – Bi-colour: 1nm / Stern - Masthead: 2nm. **Contacts:** Brass. **Bulb (included):** 12V / 10W.

### POWER 7

#### Starboard & Port - Bi-colour- Stern - Masthead - Fixed Spreader Lights



30061



30063



30065



30067



30062



30064



30066



30068

Code	30061	30062	30063	30064	30065	30066	30067	30068
Description	Starboard Light 112,5°	Port Light 112,5°	Stern Light 135°	Masthead Light 225°, Side mounted	Bi-colour Light 225°, Side mounted	Bi-colour Light 225°, Deck mounted	Masthead Light 225°, Deck mounted	Navigation Light, Fixed Spreader 360°
Housing	Black							



30071



30073



30075



30077



30072



30074



30076



30078

Code	30071	30072	30073	30074	30075	30076	30077	30078
Description	Starboard Light 112,5°	Port Light 112,5°	Stern Light 135°	Masthead Light 225°, Side mounted	Bi-colour Light 225°, Side mounted	Bi-colour Light 225°, Deck mounted	Masthead Light 225°, Deck mounted	Navigation Light, Fixed Spreader 360°
Housing	White							

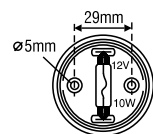
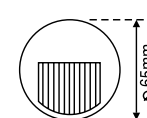
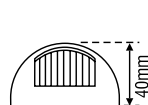
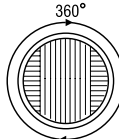
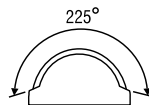
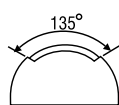
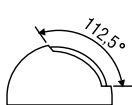

**Combine with**  
Tinned Marine Cables  
page 334

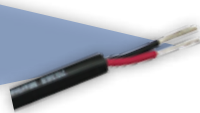

Bulb in blister  
12V/10W,  
SV8.5-8, C8I

Code | 30610



Bulb LED, 12V,T11,  
SV8.5-8, cool white -  
2x4 LEDs 360°

Code | 71227



Bulb 12V/10W,  
SV8.5-8, C8I

Code | 00568





For boats up to 7m



## JUNIOR 7

JUNIOR 7 series of navigation lights are designed for boats up to 7m length. They are waterproof, non-corrosive and non-magnetic. **Material:** Nylon fibre mix housing. Shatterproof plexi-glass (PMMA) lens. **Housing:** Available in black and white housing. **Seal:** Nitrile water resistant **Installation:** Side mounted. They are very easy to mount and their small size makes them very discreet but without compromising their effectiveness. This range is provided with a two sided adhesive tape and flange, which by sticking it on the surface you know exactly where to open the hole and the flange is already in the correct place. **Visible distance:** Port - Starboard – Bi-colour: 1nm / Stern - Masthead: 2nm. **Contacts:** Brass. **Bulb (included):** 12V / 5W.



### JUNIOR 7 Starboard & Port - Stern - Masthead Lights

30821	30822	30823	30824	30825	30831	30832	30833	30834	30835		
<b>Code</b>	30821	30822	30823	30824	30825	<b>Code</b>	30831	30832	30833	30834	30835
<b>Description</b>	Starboard Light 112,5°	Port Light 112,5°	Stern Light 135°	Masthead Light 225°	Bi-colour Light 225°	<b>Description</b>	Starboard Light 112,5°	Port Light 112,5°	Stern Light 135°	Masthead Light 225°	Bi-colour Light 225°
<b>Housing</b>	Black					<b>Housing</b>	White				

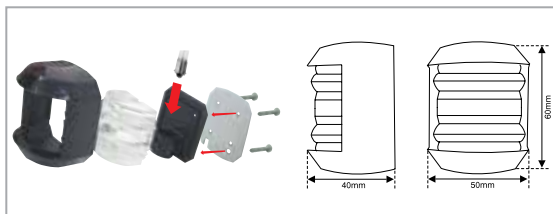

**Bulb in blister 12V/5W, BA9S, C2R**  
Code | 30940

**Bulb 12V/5W, BA9S, C2R**  
Code | 01184

**Bulb LED, 12V, BA9S, Cool White - 4SMDs + 1LED**  
Code | 71233

**Combine with**  
Tinned Marine Cables  
page 334

## JUNIOR 7 All-round Lights

These all-round pedestal lights are designed for sailboats up to 7m. These lights are much smaller in size without compromising in elegant design and efficient operating function. The pedestal fitting gives a firm attachment to the boat. Durability and longevity are ensured through the high quality manufacturing standards of LALIZAS. **Visible distance:** 2nm. **Bulb (included):** 12V/5W.

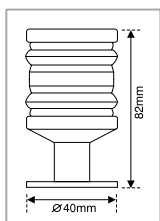

<b>Code</b>	30803	30804	30813	30814
<b>Colour</b>	White	Tri-Colour	White	Tri-Colour
<b>Housing</b>	Black			



30803	30813	30804	30814

**Bulb in blister 12V/5W, BA9S, C2R**  
Code | 30940

**Bulb 12V/5W, BA9S, C2R**  
Code | 01184

**Bulb LED, 12V, BA9S, Cool White - 4SMDs + 1LED**  
Code | 71233

For boats up to 12m

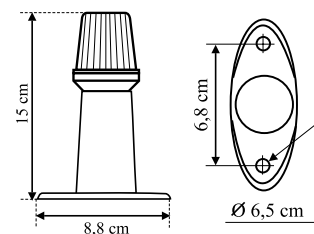

### All-round Light

<b>Code</b>	30183	30194	30303	30314
<b>Description</b>	White	Tri Colour	White	Tri Colour
<b>Base</b>	Black		White	



--	--	--	--

# Standard Navigation Lights



For boats up to 12m



## CYCLIC 12

CYCLIC 12 navigation lights are designed for powerboats and sailboats up to 12m length. Their elegant "helmet" style leaves no sharp edges to cause injury or catch lines. **Material:** They are made of tough PA6 and PMMA (plexiglass), non-magnetic stainless steel, electrical contacts and a nitrile water resistant seal to provide reliable long life. **Housing:** Available in black and white housing. **Installation:** Side mounted. **Visible distance:** Port – Starboard – Bi-colour: 1nm / Stern – Masthead: 2nm **Contacts:** Brass. **Bulb (included):** 12V / 10W.

### CYCLIC 12 Starboard & Port - Bi-colour- Stern – Masthead Lights

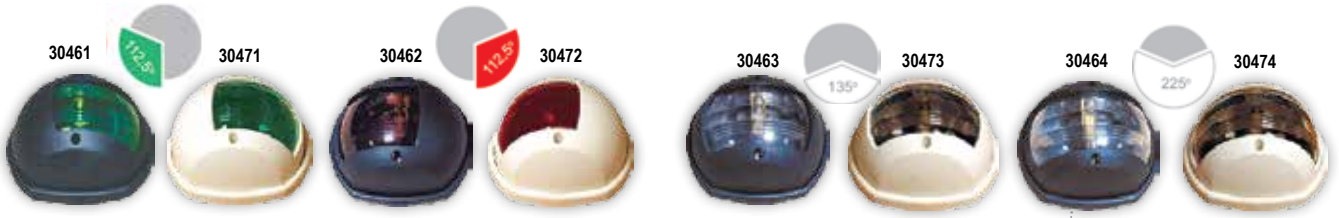

Code	30461	30471	30462	30472	30463	30473	30464	30474
Description	Starboard Light 112,5°	Port Light 112,5°	Stern White 135°	Masthead Light 225°				
Housing	Black							

Code	30471	30472	30473	30474
Description	SStarboard Light 112,5°	Port Light 112,5°	Stern Light 135°	Masthead Light 225°
Housing	White			

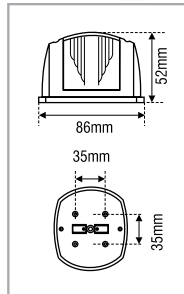

Bulb LED, 12V, T11, SV8. 5-8, cool white - 2x4 LEDs 360°

Code | 71227

Bulb 12V/10W, SV8.5-8, C8I

Code | 00568

Bulb in blister 12V/10W, SV8.5-8, C8I

Code | 30610

Electrical Equipment



### CLASSIC 12 Masthead Light & Deck Light 225°

**Housing:** Available in black colour. Bulb masthead (included): 12V / 10W. **Bulb deck light (included):** 12V / 20W. It provides ample illumination for foredeck chores. Includes universal mast mount.

Code	30499
Housing	Black



**Combine with**  
Tinned Marine Cables  
page 334

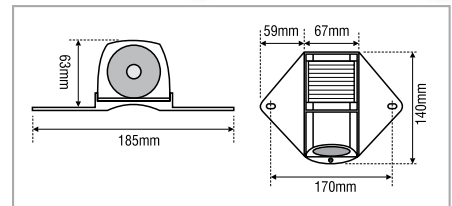

### Spare Bulb for Navigation Lights



Bulb in blister 12V/10w, Sv8.5-8, C8I

Code | 30600



Bulb 12V/10W, Sv8.5-8, C8I

Code | 00386



Bulb LED, 12V, T11, SV8.5-8, Cool White - 4 LEDs

Code | 71234



Halogen Bulb, MR16, G5.3, 12V/20W

Code | 02020



Bulb LED, 12V, MR16, G5.3, Cool White - 10 SMDs

Code | 71225

### Spare Bulb for All-round Lights

## CLASSIC 12

CLASSIC 12 series of navigation lights is designed and type-approved for boats up to 12m. It includes all-round lights, starboard & port or bi-colour lights, stern and masthead lights. There are also tri-colour lights which combine all-round light and side navigation lights. **Material:** Made of tough UV stabilized ABS plastic with shatter-proof acrylic lens, non-magnetic, stainless steel electrical contacts and a nitrile water-resistant seal to provide reliable long life. **Housing:** Available in black and white housing.

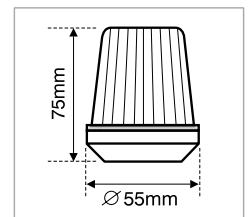

### CLASSIC 12 All-round Lights

Visible distance: 2nm, Bulb (included): 12V / 10W

Code	30111	30112	30113	30114	30133
Description	White	Green	Red	Tri-colour	White
Housing	Black				White



Bulb in blister 12V/10W, BA15S, C2R

Code | 30630



Bulb 12V/10W, BA15S, C2R

Code | 00420



Bulb 12V, LED, T18 BA15S, Cool White - 18 LEDs

Code | 71228



CLASSIC LED 12 Bulb (BA15S) for All-round Lights, 12/24V DC

Code | 72182



For boats up to 12m



## CLASSIC 12 Starboard & Port - Bi-colour- Stern - Masthead Lights

Visible distance: Port - Starboard – Bi-colour: 1nm /Stern - Masthead: 2nm. Bulb (included): 12V / 10W

Code	30091	30092	30093	30094	30095
Description	Starboard Light 112,5°	Port Light 112,5°	Stern Light 135°	Masthead Light 225°	Bi-colour Light 225°
Housing	Black				



Code	30101	30102	30103	30104	30105
Description	Starboard Light 112,5°	Port Light 112,5°	Stern Light 135°	Masthead Light 225°	Bi-colour Light 225°
Housing	White				

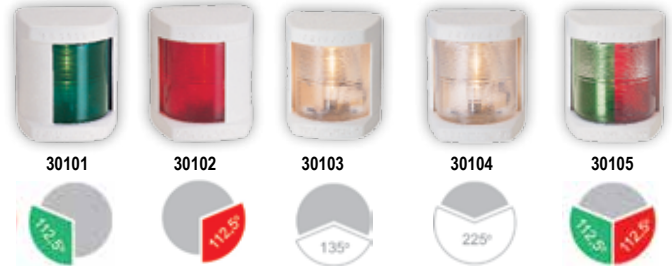

Code | 30600



**Bulb 12V/10W,**  
Sv8.5-8, C8I

Code | 00386



**Bulb LED,12V,T11,**  
SV8.5-8, Cool White  
- 4 LEDs

Code | 71234



**CLASSIC LED**  
12 Bulb Kit,  
12/24V

Code | 72183

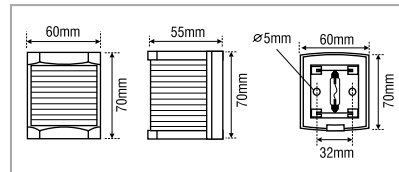

## CLASSIC 12 Combination Lights

The tri-colour version (30429/49) features all-round white and starboard & port lights, while the four-colour version (30439/59) features all-round white, stern and bi-colour light. Both sets are made of UV stabilized ABS plastic, with shatter-proof acrylic lens, non-magnetic stainless steel electrical contacts and a nitrile water-resistant seal to provide reliable long life. Both combinations are available in black and white and can be easily installed.

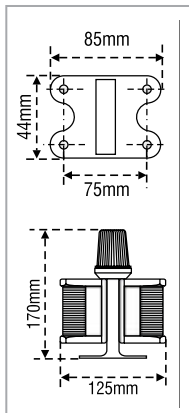

30429



30449



30439



30459

	All-round Light & Starboard & Port Lights		All-round & Stern & Bi-colour Light	
Code	30429	30449	30439	30459
Housing	Black	White	Black	White

## Spare Bulb for Navigation Lights



**Bulb in blister**  
12V/10w, Sv8.5-8, C8I

Code | 30600



**Bulb 12V/10W,**  
Sv8.5-8, C8I

Code | 00386



**Bulb LED,12V,T11,**  
SV8.5-8, Cool White  
- 4 LEDs

Code | 71234



**CLASSIC LED**  
12 Bulb Kit,  
12/24V

Code | 72183



**Bulb**  
12V/10W,  
BA15S, C2R

Code | 00420



**Bulb in blister**  
12V/10W, BA15S,  
C2R

Code | 30630



**CLASSIC LED 12**  
Bulb (BA15S) for  
All-round Lights,  
12/24V DC

Code | 72182



**Bulb 12V, LED,**  
T18 BA15S, Cool  
White - 18 LEDs

Code | 71228

Electrical Equipment



# Standard Navigation Lights



For boats up to 20m



## CLASSIC 20

CLASSIC 20 series of navigation lights is designed and type-approved for boats up to 20m. It includes all-round lights: starboard & port lights, stern light, masthead light, and tri-colour one. **Material:** Made of tough UV stabilized ABS plastic with shatter-proof acrylic lens, non-magnetic stainless steel electrical contacts and a nitrile water resistant seal to provide reliable long life. **Housing:** Available in black and white housing.

### All-round Lights

Visible distance: 2nm, Bulb (included): 12V / 25W

Code	30521	30522	30523	30543	30404
Description	All-round Light, Green 360°	All-round Light, Red 360°	All-round Light, White 360°	All-round Light, White 360°	All-round Light, Tri-colour 360°
Housing	Black			White	Black

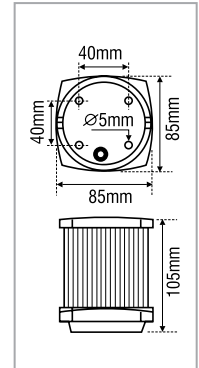

### All-round Light, Tri-colour 360°

**Housing:** Available in black colour.

**Visible distance:** 2nm.

**Bulb tri-colour (included):** 12V / 25W

**Anchor light (included):** 12V / 25W

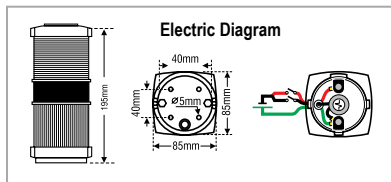

Code | 30415

To change the bulb follow the instructions as indicated in the pictures



Unscrew the casing by turning it anticlockwise



Pull the casing, and change the bulbs needed



Place the casing by matching the fasteners to the relevant slots and turning clockwise

Electrical Equipment

## CLASSIC 20 Starboard & Port - Stern - Masthead - Bi-colour Lights



Code	30501	30502	30503	30504	30505
Description	Starboard Light 112,5°	Port Light 112,5°	Stern Light 135°	Masthead Light 225°	Bi-colour Light 225°
Housing	Μαύρο				

Code	30511	30512	30513	30514	30515
Description	Starboard Light 112,5°	Port Light 112,5°	Stern Light 135°	Masthead Light 225°	Bi-colour Light 225°
Housing	Άσπρο				

Visible distance: Starboard & Port - Bi-colour - Stern: 1nm / Masthead: 3nm  
Bulb (included): 12V / 25W

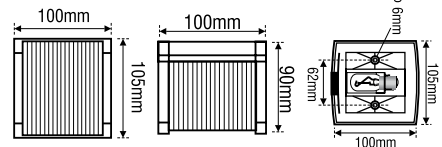

## SPARE BULBS FOR NAVIGATION & SIGNAL LIGHTS FOR BOATS UP TO 20m

For use in 12V system



Bulb in blister 12V/25W, BAY15D, C81  
Code | 30570



Bulb 12V/25W, BAY15D, C81  
Code | 00438

For use in 24V system



Bulb in blister 24V/25W, BAY15D, CC81  
Code | 30580



Bulb 24V/25W, BAY15D, CC81  
Code | 00439



Bulb LED, 12V, T25 BAY15D, Cool White - 36 LEDs  
Code | 71230



CLASSIC LED 20 Bulb (BAY15D), 12/24V  
Code | 72184

**new**

**Solar Powered Marine Light**



CE  
RoHS

Code | 198137

- The light is detachable from its base (for winter storage, reading, dining)
- Can be combined with Nuova Rade Antenna Rail Mounts
- IP65
- Italian design
- Solar panel with high charging capacity
- Rechargeable battery of 800mAh capacity to ensure operation of more than 10 hours
- Three powerful LEDs provide all around luminosity of 1,2 cd to be also used as anchor indicating light

**Nuova Rade**

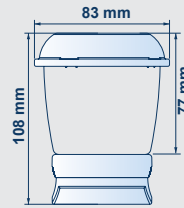

Easy installation

Permanent rail mounting base suitable for 19 mm - 25 mm boat rails

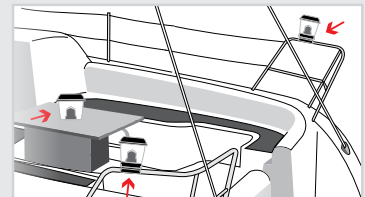

**AquaLED**

RoHS CE

**Downlight**



Code | 72396

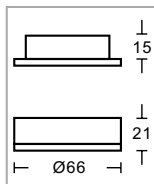

- Chromed housing
- Ø66mm
- Warm white
- 3000K
- 12 & 24V DC, Multivolt
- 3W
- IP20
- Dimmable
- Surface or flush mounted

**Dome Light, Rectangle, with Switch**

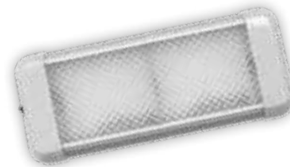

Code | 72387

- Aluminium housing
- 260x100mm
- Cool white
- 5000K
- 12 & 24V DC, Multivolt
- 9,6W
- IP20
- With switch

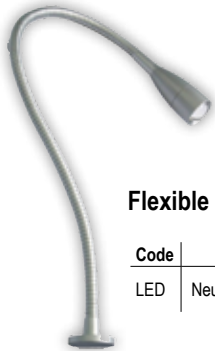

**Flexible Reading Light**

Code	72390	72391
LED	Neutral White	Red

- Satin nickel
- Bullet Head Ø28x55mm
- Flexible arm Ø10x435mm
- Neutral white or red
- 4000K
- 12 & 24V DC, Multivolt
- 1W
- With switch
- Dimmable

**Dome Light, with 3-Position Switch**



- White housing
- Ø140mm x 40mm
- White or red
- 4000K
- 3-position switch
- 12 & 24V DC, Multivolt
- 0,2W (white) / 1W (red)

Code | 72407



**Dome Light, 12 LEDs**

- White or chrome housing
- Ø75mm
- Neutral white
- 4000K
- 0,4W
- IP67 (100% sealed)
- Surface mounted
- 12 & 24V DC, Multivolt

Code	70672	70673
Housing	White	Chrome



**Dome Light, Flush mounted**

- White or chrome housing
- Ø 75mm
- Neutral white
- 4000K
- 1W
- IP67 (100% sealed)
- Dimmable
- Flush mounted
- 12 & 24V DC, Multivolt

Code	30723	30743
Housing	White	Chrome



**Dome Light, Round, with Switch**

- White or chrome housing
- Ø143mm
- Neutral white
- 4000K
- 12 & 24V DC, Multivolt
- 4,8W
- IP20
- With switch
- Surface mounted

Code	72381	72382
Housing	White	Chrome

Electrical Equipment





## Courtesy, No-glare

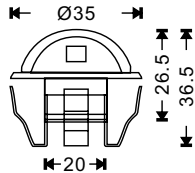

- Chromed housing
- Ø 35mm
- Neutral white / blue



- 12V DC
- 0,2W
- IP65
- Dimmable

Code	72394	72395
LED	Neutral White	Blue

## Courtesy Light, Round

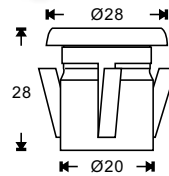

- Inox 316
- Ø 28mm
- Neutral white / blue



- 12 & 24V DC Multivolt
- 0,6W
- IP67 (100% sealed)
- Dimmable

Code	72392	72393
LED	Neutral White	Blue

## Underwater Light



- Inox 316
- Ø 94mm
- RGB (red/green/blue)



- 12V DC
- 12W
- IP68 (100% sealed)
- Surface mounted
- Working with RGB controller

Code | 72398



## RF RGB Controller for Underwater Light 72398

Code | 72494

## Underwater



- Inox 316
- Ø 94mm
- Neutral white
- 12 & 24V DC, Multivolt



- 10W
- IP68 (100% sealed)
- Dimmable
- Surface mounted

Code | 72397

Electrical Equipment

## Tape, 3m, Waterproof



- Flexible PCB with 60LEDs/m
- 3m/roll x 11mm
- Warm white



- 12V DC
- 14,4W/m
- IP67 (100% sealed)
- With 6 end caps
- Dimmable installation options
- 3M adhesive tape
- Clips & screws (included 10pcs)

Code | 72389

## Linear Light, Waterproof, 50cm

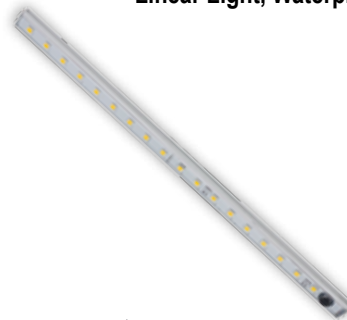

- Aluminium base
- 500x16,8mm
- Neutral white



- 5,5W
- 12 & 24V DC, Multivolt
- IP67 (100% sealed)
- With switch
- Dimmable
- Surface mounted

Code | 72388

## Swivel Lamp, 30 LEDs



- Aluminium housing
- 470x33mm
- Neutral white



- 12 & 24V DC, Multivolt
- 5,1W
- IP20
- Swivel (180°) with switch

Code | 70685

## Swivel Lamp, 10 LEDs



- Aluminium housing
- 225x33mm
- Neutral white



- 12 & 24V DC, Multivolt
- 1,95W
- IP20
- Swivel (180°) with switch

Code | 70684

## Dome Light, LED, with Movement & Light Sensor



- Material: ABS
- Bulb type: 6 LED
- Batteries: 4AA
- Automatically activated by an infrared sensor IP54

Code | 70016



## Dome Light / Trailer Light, 25 LEDs, Black



Code | 71236

- 200x58x30mm
- 12 & 24V DC, Multivolt
- 2,6W
- 187,5 lm
- Waterproof

## Dome Light / Trailer Light, 4 LEDs, Black, 2 pcs



Code | 71237

- 77x36x21mm
- 12 & 24V DC, Multivolt
- 2,6W
- 15 lm
- Waterproof

## Dome Light / Trailer Light, 12 LEDs, Black, 2 pcs



Code | 71235

- 104x60x26mm
- 12 & 24V DC, Multivolt
- 2,6W
- 90 lm
- Waterproof

# Spotlights



## Flood Light

Code	72383	72384
Housing	Black	White

- Aluminium housing
- Ø90mm
- Cool white



- 12 & 24V DC, Multivolt
- 9W
- 600lm
- IP67 (100% Sealed)
- SS304 mounting bracket



## Flood Light

Code | 72385

- White aluminium
- 66x66mm
- Cool white



- 12 & 24V DC, Multivolt
- 12W
- 900lm
- IP67 (100% sealed)
- SS304 mounting bracket



## Flood Light

Code | 72386

- White aluminium
- 145x46mm
- Cool white



- 12 & 24V DC, Multivolt
- 18W
- 1350lm
- IP67 (100% sealed)
- SS304 mounting bracket



## Flood Light

Code | 72380

- White aluminium
- Ø 116mm
- Cool white



- 12 & 24V DC, Multivolt
- 27W
- 2025lm
- IP67 (100% sealed)
- SS304 mounting bracket

# Flashlights



## Life raft LED Flashlight



It operates with AA Alkaline 1,5V x 2pcs (batteries not included)

Code | 71217

## Flashlight, 4 LEDs, 2AA



- Material: Rubber
- Bulb Type: 4 LED
- Voltage: DC 3.0VIt
- Batteries: 2AA
- Water resistant

Code | 70013

## Flashlight, 5 LEDs, 4AA



- Material: ABS
- Bulb type: 5 LED
- Light beam: 20m
- Batteries: 4AA
- Water-resistant up to 2m
- Suitable for diving

Code | 70012

## Latern LED, 4AA



- Material: ABS & PVC
- Bulb type: 8 LED
- Life time of the LED: 80,000h
- Working modes: 4LED/8LED
- Batteries: 4AA

Code | 70015

## Headlamp, LED, 3AAA



Code | 31371

- Material: ABS
- Bulb type: 8 LED
- Batteries: 3AAA
- Working modes: 2LED / 4LED / 8LED / OFF
- Waterproof Level
- Diameter: 68mm
- Size: 30x77mm
- Weight: 95.3gr

## Cap Light LED, 2 x CR2032



Code | 70014

- Material: ABS
- Bulb type: 5 LED
- Life time of the LED: 100,000hrs
- Working modes: 1LED/3LED/5LED
- Batteries: 2xCR2032 (lithium)





## Tinned Marine Cables

Code	Description	Sectional Area (mm <sup>2</sup> )	Temperature (°C)	Overall Diameter (mm)	Uses
70351	Marine Cable, Single Core, Tinned, 1x1,5 mm <sup>2</sup> , Black	1,5	≤ 105	3	Indoor & Outdoor Lighting / Navigation Lights
70352	Marine Cable, Single Core, Tinned, 1x1,5 mm <sup>2</sup> , Red	1,5		3	
70353	Marine Cable, Single Core, Tinned, 1x2,5 mm <sup>2</sup> , Black	2,5		3,6	
70354	Marine Cable, Single Core, Tinned, 1x2,5 mm <sup>2</sup> , Red	2,5		3,6	Medium Load Appliances / e.g. Refrigerator
70355	Marine Cable, Single Core, Tinned, 1x6 mm <sup>2</sup> , Black	6		5	
70356	Marine Cable, Single Core, Tinned, 1x6 mm <sup>2</sup> , Red	6		5	
70359	Marine Cable, Single Core, Tinned, 1x16 mm <sup>2</sup> , Black	16		10	
70360	Marine Cable, Single Core, Tinned, 1x16 mm <sup>2</sup> , Red	16		10	
70361	Marine Cable, Single Core, Tinned, 1x25 mm <sup>2</sup> , Black	25		11,5	
70362	Marine Cable, Single Core, Tinned, 1x25 mm <sup>2</sup> , Red	25		11,5	Battery Connections / Anchor Winch Supply
70363	Marine Cable, Single Core, Tinned, 1x35 mm <sup>2</sup> , Black	35		13	
70364	Marine Cable, Single Core, Tinned, 1x35 mm <sup>2</sup> , Red	35		13	
70365	Marine Cable, Single Core, Tinned, 1x50 mm <sup>2</sup> , Black	50		15	
70366	Marine Cable, Single Core, Tinned, 1x50 mm <sup>2</sup> , Red	50		15	
70367	Marine Cable, Single Core, Tinned, 1x70 mm <sup>2</sup> , Black	70		17	
70370	Marine Cable, Single Core, Tinned, 1x70 mm <sup>2</sup> , Red	70		17	
70371	Marine Cable, Single Core, Tinned, 1x95 mm <sup>2</sup> , Black	95		20	
70372	Marine Cable, Single Core, Tinned, 1x95 mm <sup>2</sup> , Red	95		20	
70368	Marine Cable, Twin core, Two Core, Tinned 2x1,5 mm <sup>2</sup> , Black	1,5		7	
70369	Marine Cable, Twin Core, Tinned 2x2,5 mm <sup>2</sup> , Black	2,5		9,4	



**Cable Outlet, Waterproof**

Code	For Cable (mm)	Base Diam. (mm)
99072	6	38
99073	8	38
99595	10	38



**Cable Outlet, Hexagonal, Waterproof**

Code	For Cable (mm)	Base Diam. (mm)
99737	10	50,5
99739	12	38
99736	19	50,5

## Cable Terminals



### Multi - Stack Connector

Code	Colour	For Cable (mm <sup>2</sup> )	Packing (pcs)
71240	Red	0,25 - 1,5	20
70484	Blue	1 - 2,5	20



**Packing**



### Butt Connector

Code	Colour	For Cable (mm <sup>2</sup> )	Packing (pcs)
70489	Red	0,25 - 1,5	30
70490	Blue	1 - 2,5	25
70491	Yellow	2,5 - 6	13



### Fully Insulated Disconnect - Double Crimp

Code	Colour	For Cable (mm <sup>2</sup> )	Packing (pcs)
70481	Red	0,25 - 1,5	20
70482	Blue	1 - 2,5	20
70483	Yellow	2,5 - 6	15



### Ring Connector

Code	Colour	Diameter (mm)	For Cable (mm <sup>2</sup> )	Packing (pcs)
70465	Red	4,3	0,25 - 1,5	50
70466		5,3		40
70467	Blue	4,3	1 - 2,5	40
70468		5,3		35
70469		6,4		25
70470	Yellow	5,3	2,5 - 6	15
70471		6,4		15



### Disconnect - Double Crimp, Female

Code	Colour	For Cable (mm <sup>2</sup> )	Packing (pcs)
70475	Red	0,25 - 1,5	65
70476	Blue	1 - 2,5	45
70477	Yellow	2,5 - 6	25



### Snap Plug, Female

Code	Colour	For Cable (mm <sup>2</sup> )	Packing (pcs)
70492	Red	0,25 - 1,15	20
70493	Blue	1 - 2,5	20
70494	Yellow	2,5 - 6	15



### Flanged Space Connector

Code	Colour	Diameter (mm)	For Cable (mm <sup>2</sup> )	Packing (pcs)
70485	Red	4,3	0,25 - 1,5	50
70486	Blue	4,3	1 - 2,5	40
70487		5,3		35
70488	Yellow	5,3	2,5 - 6	20







## Disconnect - Funnel Entry, Male

Code	Colour	For Cable (mm <sup>2</sup> )	Packing (pcs)
70478	Red	0,25 - 1,5	55
70479	Blue	1 - 2,5	45
70480	Yellow	2,5 - 6	25



## Snap Plug, Male

Code	Colour	For Cable (mm <sup>2</sup> )	Packing (pcs)
70495	Red	0,25 - 1,5	50
70496	Blue	1 - 2,5	45
70497	Yellow	2,5 - 6	25



## Pin Terminal

Code	Colour	For Cable (mm <sup>2</sup> )	Packing (pcs)
70472	Red	0,25 - 1,5	40
70473	Blue	1 - 2,5	35
70474	Yellow	2,5 - 6	15

# Switch Panels & Accessories

## Switch Panel Base, with Switch & Fuse, Black



The Switch Panel Base is made of hard plastic and is designed to fit in small and medium size boats. Switches on the panel include LED lights (31391), to indicate that the electrical devices on your boat receive electricity. The switches are covered with a plastic, waterproof cover to protect them from UV radiation, water and salt. Fuse holders (31392) on the panel hold 6,3A fuses and have a maximum loading of 10A. The fuses are made of polymer PTC, which stops electricity-flows in case of a short circuit. The switch panel base is combined with the frames 70581, 70584 & 70587 to meet your needs for 3, 6 or 9 switches on the central panel of your boat. It is supplied with functional labels, which indicate the type of device that each switch controls.

### Additional features:

- On-Off switches
- For use only in 12/24V DC
- Maximum loading 10A
- Completely wired and ready to install

Code	Colour	Switches	Voltage (V)
70578	Black	3 On-Off	12/24

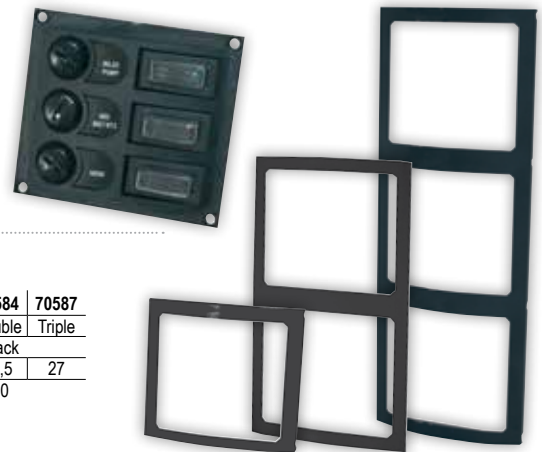

Electrical Equipment

## Switch Panel Frame, Black

Switch panel frames are made of hard plastic and are combined with the 70578 base. These frames hold one (70581), two (70584) or three (70587) switch panels which give you the option to have three, six or nine switches in line.

Code	70581	70584	70587
Description	Single	Double	Triple
Colour	Black		
Length (cm)	9,5	18,5	27
Width (cm)	10		

Combine with  
Tinned Marine Cables  
page 334

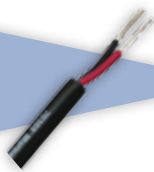

## Function Labels for Switch Panels, 24pcs

Code	70589
------	-------



## Switch Panel Key, ON-OFF, 12V/24V

Code	31391
------	-------

## Switch Panel Key, MON-OFF, 12V/24V

Code	70588
------	-------

## Pump Switch, Inox 316

LALIZAS Pump Switch allows you to operate your boat's bilge pump automatically, manually or even switch it off. It is water-resistant, with indication light so that you know when the device is operating. Made of Inox 316 for durability and lifetime protection against corrosion. It is available in charcoal colour.

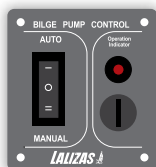

### Additional features

- Auto-Off-Manual switch
- For use only in 12/24V. Max. load per switch: 15A
- Coated with electrostatic paint
- Completely wired and ready to install
- 2 year warranty

**INOX 316**

**2 YEARS GUARANTEE**

Code	Switch	Dimensions (cm)		Colour	Voltage (V)
		Height	Width		
31301	Auto-Off -Manual	7	6,5	Charcoal	12-24

## Windlass Switch with Light, Inox 316, Charcoal, 12/24V



- Mon-Off-Mon switch
- For use only in 12/24V. Max. load per switch: 15A
- Coated with electrostatic paint
- Completely wired and ready to install
- 2 year warranty

Code	Switch	Dimensions (cm)		Colour	Voltage (V)
		Height	Width		
99693	Mon-Off-Mon	7	6,5	Black	12-24

## “SP Ultra” Switch Panel, Inox 316

LALIZAS Switch Panels “SP Ultra” have been especially designed for use on small and medium sized boats. They allow you to control any desired device, such as bilge pumps, navigation or cabin lights etc. at the touch of a button. They feature waterproof switches for the protection against water. Made of brushed Inox 316 for durability and resistance to corrosion and harsh conditions. They are available in five models with 3, 4, 6, 9 and 12 switches and in two colours (as per table).

### Additional features:

- On-Off switches
- For use only in 12/24V DC. Max. load per switch: 10A
- Panels in charcoal colour are coated with electrostatic paint
- Completely wired and ready to install
- 3 year warranty

**3**  
YEARS  
GUARANTEE

**INOX**  
**316**

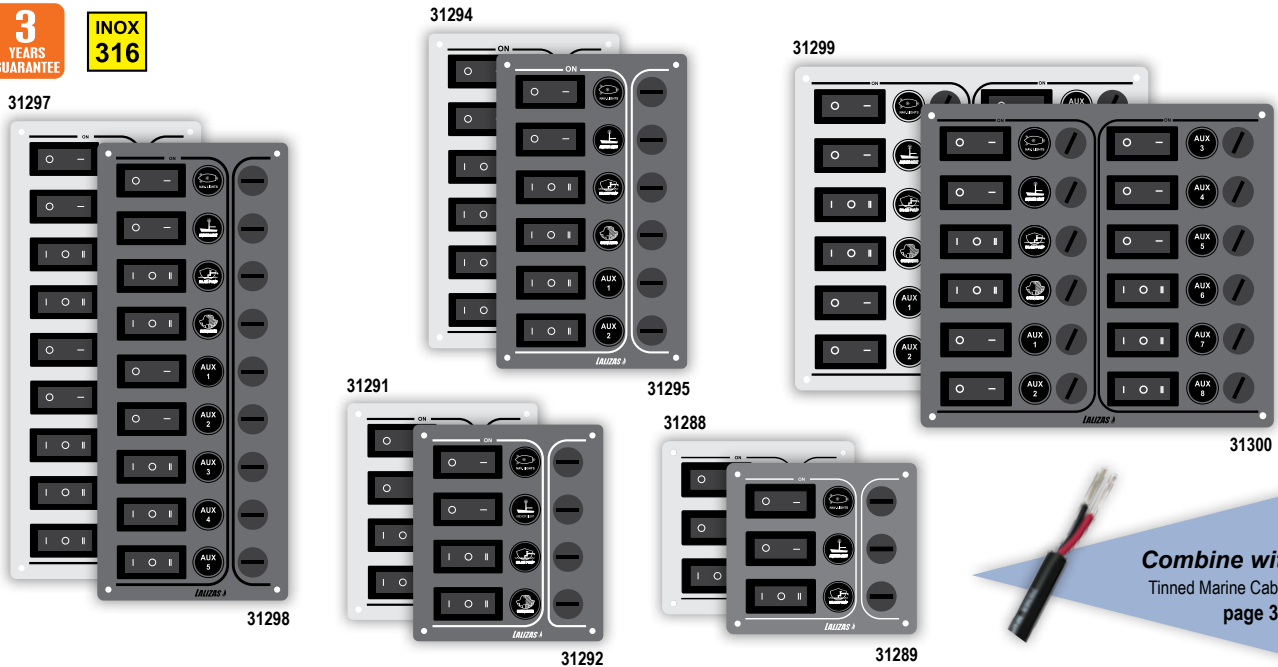

Code	Description	Colour	Switches	Dimensions (cm)		Voltage (V)
				Height	Width	
31288	“SP3” Ultra	Inox	2 ON-OFF, 1 ON-OFF-MON	9	10	12/24
31289	“SP3” Ultra	Charcoal	2 ON-OFF, 1 ON-OFF-MON	9	10	12/24
31291	“SP4” Ultra	Inox	2 ON-OFF, 1 ON-OFF-MON, 1 ON-OFF-ON	11,5	10	12/24
31292	“SP4” Ultra	Charcoal	2 ON-OFF, 1 ON-OFF-MON, 1 ON-OFF-ON	11,5	10	12/24
31294	“SP6” Ultra	Inox	2 ON-OFF, 1 ON-OFF-MON, 2 ON-OFF-ON, 1 MON-OFF	16,5	10	12/24
31295	“SP6” Ultra	Charcoal	2 ON-OFF, 1 ON-OFF-MON, 2 ON-OFF-ON, 1 MON-OFF	16,5	10	12/24
31297	“SP9” Ultra	Inox	4 ON-OFF, 2 ON-OFF-MON, 2 ON-OFF-ON, 1 MON-OFF	24	10	12/24
31298	“SP9” Ultra	Charcoal	4 ON-OFF, 2 ON-OFF-MON, 2 ON-OFF-ON, 1 MON-OFF	24	10	12/24
31299	“SP12” Ultra	Inox	7 ON-OFF, 2 ON-OFF-MON, 2 ON-OFF-ON, 1 MON-OFF	18	16,5	12/24
31300	“SP12” Ultra	Charcoal	7 ON-OFF, 2 ON-OFF-MON, 2 ON-OFF-ON, 1 MON-OFF	18	16,5	12/24

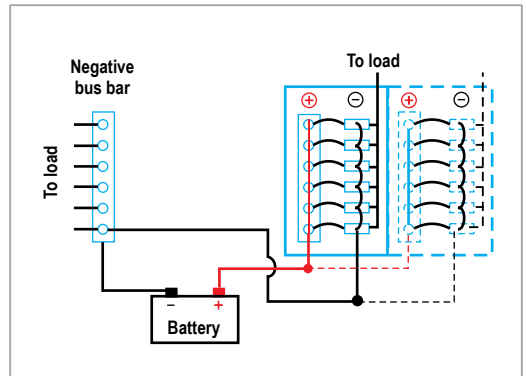

Electrical Equipment

## Switch Panel “SP Economy”, Inox 316

LALIZAS Switch Panels “SP Economy” have been especially designed for use on small and medium sized boats. They allow you to control any desired device, such as bilge pumps, navigation or cabin lights etc. Both switches and fuse holders are waterproof for protection against water. Made of Inox 316 for durability and resistance to corrosion & available with 3 and 6 toggle switches.

## Switch Panel, 5 Waterproof Switches & Autom. Fuses, Inox 316, 12V

- With charging socket
- Inox 316

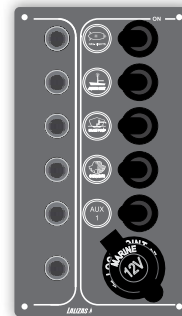
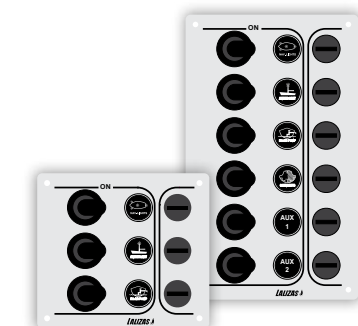

Code	Description	Colour	Switches	Dimensions (cm)		Voltage (V)
				Height	Width	
31380	“SP3 Economy”	Inox	2 ON-OFF, 1 ON-OFF-MON	9	10	12/24
31381	“SP6 Economy”	Inox	2 ON-OFF, 1 ON-OFF-MON, 2 ON-OFF-ON, 1 MON-OFF-MON	9	10	12/24

Code	Switches	Dimensions (cm)		Voltage (V)
		Height	Width	
70990	2 ON-OFF, 1 ON-OFF-MON, 1 ON-OFF-ON, 1 MON-OFF-MON	17	10	12/24



**Fuse Holder, with Fuse, 10A, 250V**

Code | 70959



**Toggle Switch ON-OFF, 2 Positions, 12V/24V**

Code | 01888



**Toggle Switch, ON-OFF-ON, 3 Positions, 12V/24V**

Code | 01889



**Toggle Switch MON-OFF-MON, 3 Positions, 12V/24V**

Code | 01890



**Automatic Waterproof Thermal Fuse, 10A**

Code | 31395



**Switch Panel Key, ON-OFF, 12V/24V**

Code | 31391



**Switch Panel Key, MON-OFF, 12V/24V**

Code | 70588



**Switch Panel Key, ON-OFF-ON, 12V/24V**

Code | 70956



**Switch Panel Key, ON-OFF-MON, 12V/24V**

Code | 70957

## Switch Panel "SP Offshore", Inox 316

LALIZAS Switch Panels "SP Offshore" are mainly designed for exterior use on small and medium sized boats. They have waterproof switches with a LED bulb, indicating when switch is On/Off and automatic thermal switches, which reset for protection against any reverse current. Made of Inox 316 for durability and resistance to corrosion and electrostatic painted in charcoal colour. Available with 3 and 6 waterproof switches.

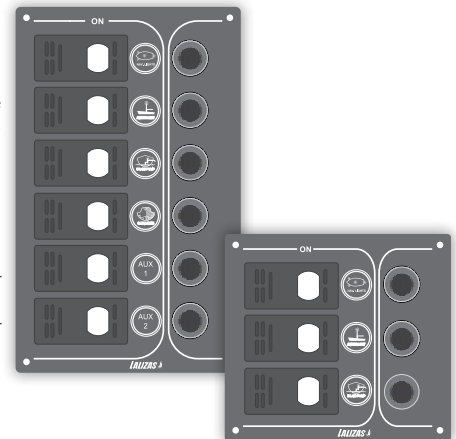

Electrical Equipment

Code	Description	Colour	Switches	Automatic fuses	Dimensions (cm)		Voltage (V)
					Height	Width	
31384	"SP3 Offshore"	Charcoal	2 ON-OFF, 1 ON-OFF-MON	3	11	12	12
31385	"SP6 Offshore"	Charcoal	2 ON-OFF, 1 ON-OFF-MON, 2 ON-OFF-ON, 1 MON-OFF-MON	6	19,5	12	12



**Switch 15A, Waterproof, with LED Light**

Code	Positions	Switch
99726	4	ON-OFF
99728	6	ON-OFF-MON
99729	6	MON-OFF-MON
99730	6	ON-OFF-ON



**Automatic Thermal Fuse, Waterproof, 10A**

Code | 31395



**Self-adhesive Transparent Function Labels for 99726, 99728-30, Set of 25pcs**

Code | 71208



**Self-adhesive Function Labels for Switch Panels, Set of 24pcs**

These labels are ideal for use with LALIZAS Switch Panels "SP" and "SP Ultra". They are very simple to mount, easy to read and they are made to withstand long-term use. Each set includes 24 labels.



Code | 11497

### Instructions of use

First clean the surface with pure alcohol. Remove the back paper of the label. Attach the latter to the cleaned surface by slightly pressing it. During wintertime, first warm up the top of the labels using a hairdryer, before applying.

## Switch Panels & Accessories

### Switch Panel with Conventional Switches

"LPS 4" has been designed for the complete control of various electrical devices of the boat from one position. It is a four-switch panel, available in four combinations of switches (ON-OFF, ON-OFF-ON, MON-OFF-MON) and can be combined with more panels of the same kind to cover as many operations as needed. LED lights, resettable PTC fuses are some of the most important features that will make the difference on board. Electrical and electronic circuits of the panel are completely sealed off by means of silicon cables and a durable plastic internal cover. "LPS-4" is made of Nylon 6 plastic and does not need any maintenance under normal conditions of use.

#### Additional features:

- Durable, UV - water - salt resistant, conventional switches protected by high quality neoprene rubber boots
  - Solid state resettable PTC fuses that, on over-current, change to a high resistance device
  - Covered bolts and screws
  - Various combinations of switches (ON-OFF, ON-OFF-ON, MON-OFF-MON)
  - LED Lights indicate operating devices
- Available in black colour.



Code	Description	Colour	Switches	Fuses	Size in cm			Voltage (V)
					Height	Width	Thickness	
31180	LPS-401	Black	ON-OFF	Polyfuse	10	10	1	12V
			ON-OFF					
			ON-OFF					
31182	LPS-402		MON-OFF-MON					
			ON-OFF-MON					
			ON-OFF-MON					
31184	LPS-403		ON-OFF					
			MON-OFF-MON					
			ON-OFF-MON					
31186	LPS-404		ON-OFF-MON					
			ON-OFF-MON					
			ON-OFF-MON					
		ON-OFF						

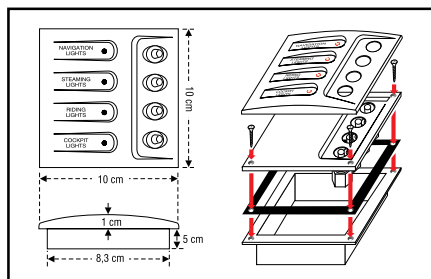

**Toggle Switch  
MON-OFF-MON, 3-Posi-  
tion**

Code | 01890



**Toggle Switch, ON-  
OFF-ON, 3 Positions,  
12V/24V**

Code | 01889



**Toggle Switch ON-OFF,  
2 Positions, 12V/24V**

Code | 01888

Electrical Equipment



### Case for Electrical Control Panel, with Lid, White

Nuova Rade Case for Electrical Control Panel with Lid is ideal for every sailboat or yacht. Available in dimensions of 275 x 375 x 75 mm and in white colour, it can cover the needs of boats of any size. It is ideal for storing the boat's electrical control panel. Made of UV-resistant high-grade ASA plastic, it provides resistance to damage and chemical solvents. Preferably designed for internal use. UV-resistant cover, frame and container with a 150° opening door and a durable handle. It is specially designed with a non-skid surface and can be mounted vertically. This case is mounted with hidden screws for discrete appearance. EPDM rubber gasket provides resistance to water. It guarantees easy opening and easy access when needed.

Code | 196663

A (mm)	B (mm)	C (mm)	D (mm)	E (mm)	F (mm)	G (mm)
275	375	180	280	75	200	300

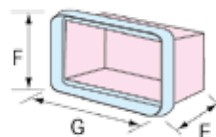
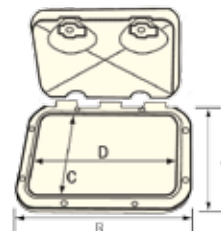

## Fuses & Accessories

### Fuse for Switches

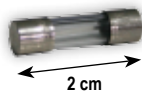

Code	71005	71006
Amps	10	15
Diam. Ø	5 mm	

2 cm

### Fuse Holder with Fuse, 10A, 250V



Code | 70959



### Automatic Thermal Fuse, 10A

Code | 31395

## Automotive Fuse



Code	Amps
90742	3
90743	5
90744	10
90745	15
90746	20
90747	25
90748	30

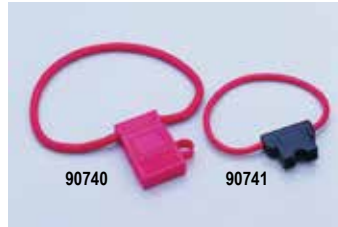

Fuse Holder, Waterproof, Automotive Style Fuse, PVC

Code | 90740

Fuse Holder for Automotive Style Fuse, Bakelite

Code | 90741

## Fuse & Terminal Block, 12V, 20A



Code	Dimensions (cm)	Contacts
99745	8,3x7,6	4
99746	8,3x12,5	6
99747	8,3x15	8

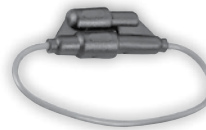

Fuse Holder, Waterproof, 203mm Loop

Code	Fuses	Amps	Wire (mm)
99549	2	10	1,3
99550	2	15	1,6

# Bus Bars & Terminal Blocks

## Bus Bar from Copper



Code	Contacts	Amp
99748	4	150
99749	5	100
99750	6	150
99751	10	150
99752	12	250
99753	20	150

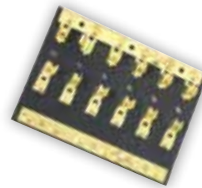

Fuse & Terminal Block 12V, 20A

Code	Dimensions (cm)	Contacts
99745	8,3x7,6	4
99746	8,3x12,5	6
99747	8,3x15	8



Terminal

Code	Contacts
99754	4
99790	6
99791	8



Waterproof Connection Box, 2 Terminal Strips

Code	Contacts
99733	4
99734	8

Electrical Equipment

# Switches



Switch Panel Key, ON-OFF, 12V/24V

Code | 31391



Switch Panel Key, MON-OFF, 12V/24V

Code | 70588



Switch Panel Key, ON-OFF-ON, 12V/24V

Code | 70956



Switch Panel Key, ON-OFF-MON, 12V/24V

Code | 70957



Toggle Switch, ON-OFF, 2 Positions, 12V/24V

Code | 01888



Toggle Switch, ON-OFF-ON, 3 Positions, 12V/24V

Code | 01889



Toggle Switch, MON-OFF-MON, 3 Positions, 12V/24V

Code | 01890



Toggle Switch, ON-OFF-MON, 3 Positions, 12V/24V

Code | 70958

## Switches



**Switch 15A, Waterproof, with LED Light**

Code	Positions	Switch
99726	4	ON-OFF
99728	6	ON-OFF-MON
99729	6	MON-OFF-MON
99730	6	ON-OFF-ON



**Push Button Horn Switch, 12V, 10A, with Rubber Protector**

Code | 99041



**Frame for Switch on the Two Sides, for 99726-99730**

Code | 99731



**Frame for Switch on the Central Part, for 99726-99730**

Code | 99732

**Push Button Horn Switch, 20A, Waterproof, Ø16mm, L 73mm**



Code	Cap
98707	Red
98708	Black



**Push Pull Switch, 12V, 5A, Ø 8mm, L7mm, Chrome Plated, Brass Knob**

Code | 99034



**Push Button Switch, 12V, Ø 16mm, L32mm, Chrome Plated, Brass Knob**

With caoutchouc cover

Code | 99040



**Push Pull Switch, 12V, 20A, Ø 9,5mm, L30mm, Chrome Plated, Brass Knob**

Code	Switch
99036	On-Off
99037	On-Off-On



**Push Button Switch, 12V, 20A, Chrome plated, Brass Knob**

Code	Dimensions (mm)
99038	Diam.: 16 / L.: 32
99039	Diam.: 12,7 / L.: 32



**Horn Starter Button, Push Pull On/Off, 2 Positions, 12V, 20A, Ø 9.5mm, L78mm**

Code | 98705



**Horn Starter Button, Push Pull On/Off, 3 Positions, 12V, 20A, Ø 9.5mm, L97mm**

Code | 99545



**Horn Starter Button Switch, 12V, 20A, Ø 16mm, L70mm**

Code | 99546



**Horn Starter Button, On/Off, 2 Positions, 12V, 20A, Diam.8mm, L40mm**

Code | 99547

## Power Shore Plugs & Sockets



53249

53250



Code	Voltage (V)	Current (A)
53249	220	16
53250	220	32

### Case for Electric Power Shore Center, White



Nuova Rade high quality Cases for Electric Power Shore Center are ideal for controlling high current devices such as winches, capstans, and other equipment. Contain an ASA outer case that makes them impervious to hydrocarbons and temperature fluctuations. Have a hinged cover that is resistant to shocks and UV-rays. They are pre-wired for easy installation to the boat's network. Comes with a bi-polar residual circuit breaker and LED indicator when switched on. With European plug. Maximum Voltage of 220V.

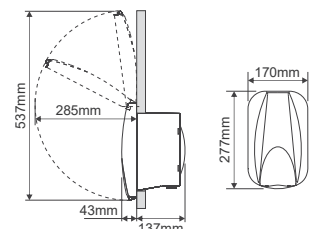



**Plug, Male, 16A, 220-240V, Blue**

Code | 90394



**Plug, Male, with Safety Ring, 16A, 220- 240V, Blue**

Code | 90397



**Plug, Female, with Safety Cover, 16A, 220-240V, Blue**

Code | 90396



**Plug, Female, with Cover, 16A, 220-240V, Blue**

Code | 90395



**Cord Set with Female Plug 16A & Schuko Connector 16A, 220-240V, 30cm Cable, Blue**

Code | 90398



## Marine Plug and Socket, Set, 12V

The Marine Plug and Socket Set is ideal for all devices that need electrical power to operate, such as mobile phones, flashlights etc. Made of corrosion resistant nylon material, it is equipped with a built-in 5A fuse and a luminous LED power indicator light. It features a watertight cap to prevent water intrusion and an interconnecting system that securely locks the plug into the socket. It is suitable for use only in 12V DC and is available in black colour.

Code | 31306



**Marine Plug, 12V**

Code | 31350



**Marine Terminal Socket, 12V**

Code | 31307

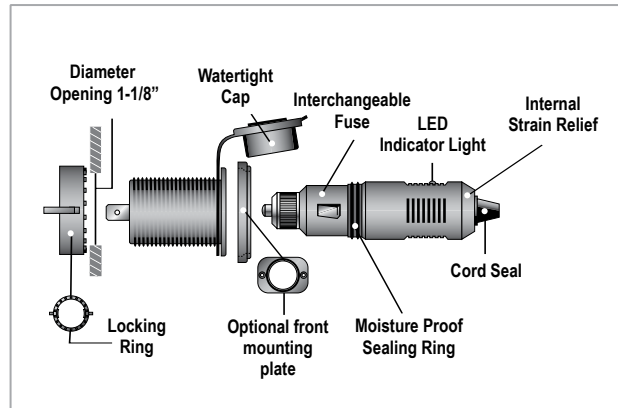

Electrical Equipment



**Cigarette Lighter USB Charger, 12/24V DC**

Code | 72483

Input Voltage: 12/24V DC  
Output Voltage: 5V DC



## Dual Port USB Socket, 12/24V DC

- Short circuit & overheat protection
- Suitable for all smartphones & tablets charging
- Fast charging at full speed 2,4A (for iPad & iPhone) / 1A (for Androids)
- 100% water-resistant with protection cap closed

Code | 72484

Input voltage: 12/24V DC  
Output voltage: 5V DC

## 16 Amps (30A) / 220V - 250V



**Power Inlet "Ratio Electric", Inox, 16A, 250V, with Rubber Cover**

Code | 90407



**Female Connector, 16A/250V, with Cover**

Code | 70973



**Power Inlet, Inox 316, 16Amp (30A) / 220V 50Hz**

- Easy lock system
- Soft touch cap design
- Rear safety enclosure with strain relief

Code | 98275



**Female Connector, 16Amp (30A) / 220V**

Code | 98278



**Waterproof Cover with Threaded Ring for 98278**

Code | 98280

## Power Shore Plugs & Sockets



### Plug & Socket, Set

Code	99776	99777	99778	99779	99780	99781	99782	99783	99784	99775	99788	99789
Amps	3	3	3	5	5	5	3	3	3	5	5	5
Pins	2	3	4	2	3	4	2	3	4	2	3	4
Cap	Brass						Plastic					



### Adapter Schuko to CEE, for Cord Sets, L30cm

Code | 90410



### Cord Set "Ratio Electric", 16A, 250V, 1,5mm<sup>2</sup> – L 15m

Code | 90406

## Solar Panels



### Solar Panel, Monocrystalline

- State-of-the-art technology in cell manufacturing and encapsulation results in maximum reliability combined with minimum maintenance.
- High resistance to water, abrasion, hail impact and other environmental factors
- Anodized aluminium alloy frame
- Low iron, high transparency, tempered glass cover
- Designed and manufactured to comply with European and International standards

**Warranty:**  
Limited warranty on power output  
Warranty: 10 years 90% - 20 years 80%

**Combine with**  
Tinned Marine Cables  
**page 334**



Code	70904	70905	99210	70906	99211	99212	99213	99214
<b>DIMENSIONS &amp; SPECIFICATIONS</b>								
Cell Type	Monocrystalline							
Cell Dimensions (mm)	125x125							
Length (mm)	280	320	454	485	554	636	770	1195
Width (mm)	195	294	294	360	449	554	668	545
Thickness (mm)	18	18	18	20	25	30	30	35
Weight (Kg)	0,7	1,2	1,9	2,3	2,9	4,3	6,1	8,5
<b>ELECTRICAL SPECIFICATIONS</b>								
Maximum Power Rating (W)	5	10	15	20	30	50	75	100
Tolerance of the rated output power	±3%							
Short circuit current (A)	0,29	0,58	0,89	1,19	1,73	2,88	4,32	5,85
Open circuit current (V)	22,64	22,64	22,13	22,58	22,64	22,64	22,64	22,54
Rated Voltage (V)	18,57	18,57	18,44	18,82	18,57	18,57	18,57	18,78
Rated Current (A)	0,27	0,54	0,82	1,08	1,62	2,70	4,04	5,34
Maximum permitted system voltage (V)	12							

### Solar Panels' General Use

Code	Watt	Use
70904	5	Ideal for the maintenance and/or charging of small batteries (mobile, laptop etc.). It can also be used for trickle charging (maintenance) of the batteries so as to be ready for use at all times.
70905	10	
70905	10	Ideal for the maintenance of one or two batteries on the boat. Suitable for charging portable electronic devices & for the maintenance of small or medium size batteries, so as to keep them charged during the boat's winterization.
99210	15	
70906	20	Ideal solution for the maintenance and charging of one or two medium capacity batteries on the boat, used for all the applications. Batteries' protection during the boat's winterizing.
99211	30	
99212	50	
99212	50	Suitable for charging big capacity batteries used for all the applications on the boat. Ideal for charging the batteries used for a small cabin's electricity, the boat's fishing tools, etc.
99213	75	
99213	75	Suitable for charging batteries of big capacity used for all the applications on the boat. Ideal for charging the batteries used for the cabin's electricity, the continuous function of the refrigerator, the heating, etc.
99214	100	

**Note:** The solar panels mentioned in this table can either be installed separately or as an array (in a row) of two or more panels, according to the boat's electricity needs and batteries' capacity.





**Solar Charge Controller, 12/24V**

**General Characteristics**

- Automatic lighting control function
- Ideal for areas with increased humidity, such as boats, outdoor pathway lighting, parking areas etc.
- Suitable for 12/24V lamps
- Selection of the battery type (AGM, Flood & Gel)
- Waterproof (IP67)
- 100% protection against humidity

**Technical Specifications**

- Type of charging: 4 stages PWM charging (Bulk – PWM – Boost – Float)
- Rated solar input: 10A
- Rated load: 10A
- Regulation voltage: 14.4V
- Load disconnect: 11.08V
- Load reconnect: 12.58V
- Self-consumption: Max. 6mA
- Temperature: -35 to +55
- Terminals: For 2.5mm cables
- Protection against short circuit, over current, overload, reverse polarity, battery reverse current at night, high load voltage
- LED indications for charging, battery levels, low voltage, disconnect, etc.
- Weight: 250gr
- Dimensions: 140x70mm

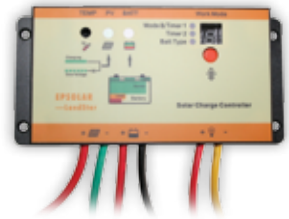

Code | 90287



**Blower for Autonomous Solar Powered Fan**

Code	Volt	Battery
60070	1.2	✓
60065	12	-

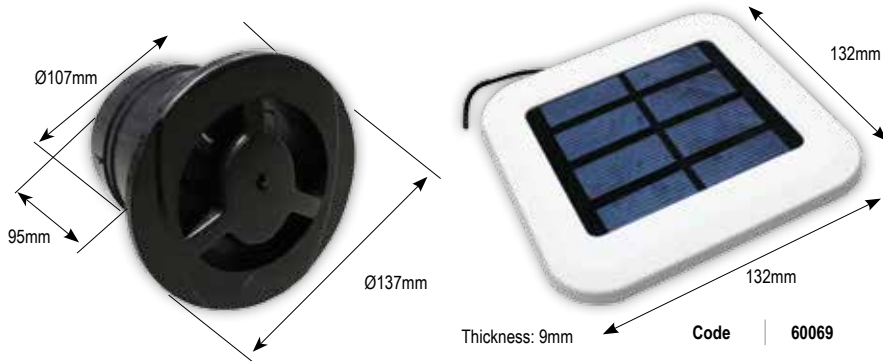

**Solar Cell for Autonomous Solar Powered Fan**

Code | 60069

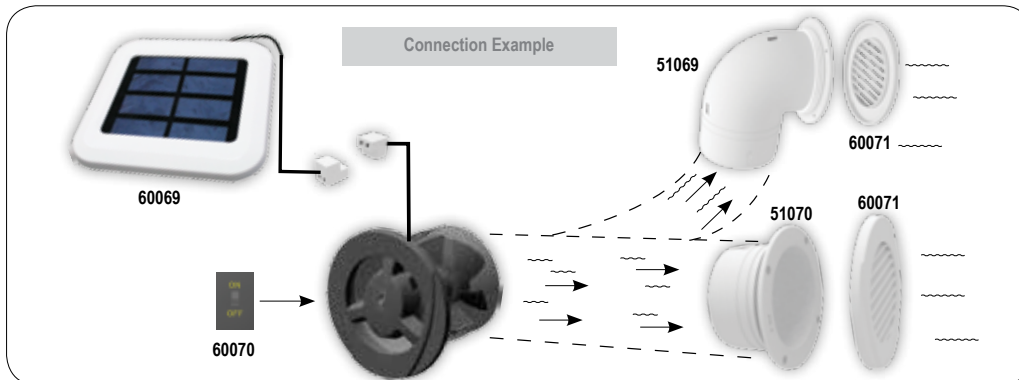

Electrical Equipment

**Inverters**



**Modified Sine Wave Inverter**

A power inverter is an electronic device that converts low voltage 10-15V DC (direct current) battery power to 220 - 230V AC (alternating current) household power, when shore power is not available. Power inverters are ideal for trips with the boat or car to power laptops, cell phones and many other appliances. There is protection against overload, over temperature and low battery conditions, with the automatic shutdown of the power inverter. A cigarette lighter plug is included. Available in 150W, 300W, 500W & 1000W.



Code	31373	31374	31375	31376
Max. Continuous Power (W)	150	300	500	1000
Peak Power (W)	300	600	1000	2000
Input Voltage Range (V)	10 - 15			
Output Voltage (V)	220 - 230			
Frequency	50 Hz			
Dimensions (L x W x H mm)	150x105x55	150x105x55	180x105x55	240x150x70
Weight (Kg)	0,5	0,6	0,74	2,3

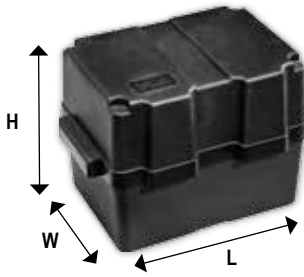

Code | 196508

## Battery Box up to 80Ah

- External dimensions (LxWxH): 340x230x250mm
- Internal dimensions/Maximum battery size (LxWxH) = 280x195x230mm
- Designed for batteries up to 280mm long (of group sizes 24, 25, 34, 35, among others)
- Mounting equipment: Includes durable hold-down fastening strap and foot clamps that secure the strap onto the supporting surface (screws not included)

- Restrains battery movement
- Collects battery acid
- Made of polypropylene
- Acid, UV and heat resistant
- Side handles to facilitate transportation
- Lift-off lid for unobstructed inspection
- Cable ports for untangled, safe cables

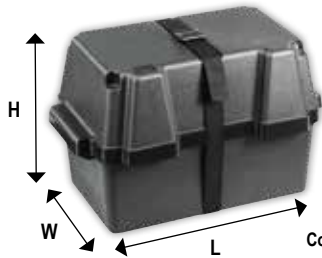

Code | 195539

## Battery Box up to 100Ah

- External dimensions (LxWxH) = 431x257x256mm
- Internal dimensions / Maximum battery size (LxWxH) = 339x199x224mm
- Can hold battery up to 339mm long, of various group sizes (e.g. 46, 53, 92 and others)
- Mounting equipment: Includes durable hold-down fastening strap and foot clamps that secure the strap onto the supporting surface (screws not included)

- Restrains battery movement
- Collects battery acid
- Made of polypropylene
- Acid, UV and heat resistant
- Side handles to facilitate transportation
- Lift-off lid for unobstructed inspection
- Cable ports for untangled, safe cables

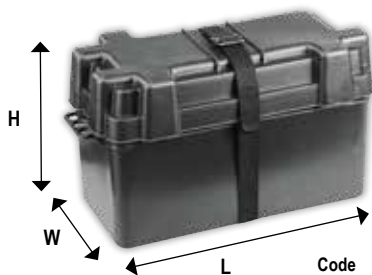

Code | 17518

## Battery Box Up To 120Ah

- External dimensions (LxWxH) = 470x225x255mm
- Internal dimensions / Maximum battery size (LxWxH) = 385x175x225mm
- Can hold battery up to 385mm long, of various group sizes (e.g. 27, 49, 93 and others).
- Customizable length: Includes separator that divides the box into partitions, ranging from 50 to 330mm long.
- Mounting equipment: Includes durable hold-down fastening strap and foot clamps that secure the strap onto the supporting surface (screws not included)

- Restrains battery movement
- Collects battery acid
- Made of polypropylene
- Acid, UV and heat resistant
- Side handles to facilitate transportation
- Lift-off lid for unobstructed inspection
- Cable ports for untangled, safe cables

Electrical Equipment

### Tips to choose the best fit for your battery

- Ideally, choose the internal dimensions to be equal or slightly larger than your battery
- Use a spacer where it is needed to prevent the battery from moving within the box
- Remember to include the height of the terminals while measuring the battery



**Strap for Fuel Tank/Battery Box Fixing, Length 1,30m**

Code | 43895



**Bracket for Battery Box/Fuel Tank, with Strap 1,50m**

Code | 43897



**Universal Base with Strap, 480mm x 35mm x 178mm**

Code | 43901

Code | 43760



**Protection Covers for Battery Terminals**



**Battery Terminal, Zinc**

Code | 98732



**Battery Terminals, Brass, Set**

Code | 98733



**Battery Terminal, Swan Type**

Code | 98734



**Battery Holder Tray**

Code	Length (cm)	Width (cm)
99560	28	17,8
99561	33	17,8



**Battery Box Power, Plastic**

Code	Length (cm)	Width (cm)	Height (cm)
98737	34	20	23
Battery max. dimension	33	19	22

Battery Switches



**Case with Battery Switch, with Watertight Lid**

It has an integrated battery switch and a case to protect it from external factors. Made of ASA material. Watertight gasket included.

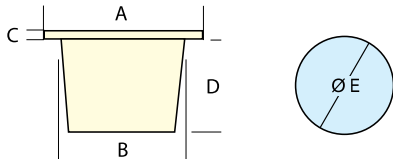

Code	Colour	Capacity
196384	White	100 A (500 A for 10 sec. max)
196385		250 A (1000 A for 10 sec. max)
196388	Cream	100 A (500 A for 10 sec. max)
196389		250 A (1000 A for 10 sec. max)

  

A (mm)	Ø B (mm)	C (mm)	D (mm)	Ø E (mm)
95	68	5	72	68



**Case for Battery Switch with Watertight Lid**

It has a UV-resistant outer case made of ASA in order to store the battery and protect it from external factors. Watertight gasket is included.

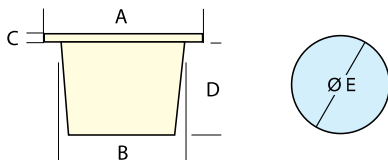

Code	Colour
196383	White
196387	Cream

A (mm)	Ø B (mm)	C (mm)	D (mm)	Ø E (mm)
95	68	5	72	68



Electrical Equipment

**new**

**Battery Switch**

Code	Max. Current	Shape
99558	100A	Round
195051	250A	
74578	100A	Square
90165	250A	



**Battery Switch, Heavy-duty Type, 12V**

Code	99970
Continuous	300Amps
Momentary	1000Amps for 10sec



**Battery Switch, 4 positions, 12V, for Two Batteries**

With ABS cover

Code	91550
Continuous	175 Amps
Momentary	300 Amps



**Battery Switch, 12V, for Two Batteries**

With bakelite cover

Code	91551
Continuous	175 Amps
Momentary	300 Amps

**new**

## Two-way Speakers, 100W, 6 1/2", Non-magnetic, with Clip-on Cover, White, Set



Code | 74576

Ideal for use in boats, the Two-way Speakers are waterproof and corrosion-resistant while they can be hosed down when the boat is being cleaned. Having non-magnetic design, they don't disturb instruments or compasses and their ASA cover provides improved endurance in both sea and sun exposure. They also feature waterproof and corrosion-resistant mica injection cone with TPU edge and corrosion-resistant silicone coated terminal wire. Can be mounted either horizontally or vertically. Suitable for indoor and outdoor use. Available in white colour. CE approved.

### Technical Specifications:

- Impedance: 4 Ohm
- Sensitivity: 90 dB
- Frequency Response 60-18000 Hz
- Max Power 100W (per pair)
- RMS Power 80W (per pair)

### Mounting Dimensions:

- Depth: 64mm
- Hole diameter: 136mm
- Magnet: 350g (8oz + 4.3oz)



## 2 Way Speaker Set

With Nuova Rade Speakers installed in your boat, you can relax or party - listening to your favourite music. Ideal for use in boats, since they are water (31302 & 31303) and corrosion proof. The 2-way speakers may be mounted both indoors and outdoors.



### Technical Specifications

#### 31302

- 5 1/4" 2 Way Speaker Set 80W
- Impedance: 4 Ohm
- Sensitivity: 88db
- Frequency Response: 80-18000 Hz
- Max: 80W (per pair)
- RMS Power: 70W (per pair)
- Material: UV-stabilised ABS plastic
- Dimensions: 5,25"(13,34cm)

#### Mounting Dimensions

Depth: 53mm, Hole: 115mm  
Magnet: 238g (5.4oz + 3oz)

#### 31303

- 6 1/2" 2 Way Speaker Set 100W
- Impedance: 4 Ohm
- Sensitivity: 90db
- Frequency Response: 60-18000 Hz
- Max: 100W (per pair)
- RMS Power: 80W (per pair)
- Material: UV-stabilised ABS plastic
- Dimensions: 6,5" (16,5cm)

#### Mounting Dimensions

Depth: 64mm, Hole: 136mm  
Magnet: 411g (8oz + 6.5oz)

Code	31302	31303
Diameter (Inches)	5' 1/4"	6' 1/2"
Power (W)	80	100
Colour	White	White

Electrical Equipment

# Replacement Bulbs

## LED



Code	SMD	Colour	Volt - Lumen	Dimensions	Base Tupe	Filament Types
71225	10	Cool White	12V - 150	Ø 50mm 45mm	 G 5.3	 MR16











Code	SMD	Colour	Volt - Lumen	Dimensions	Base Tupe	Filament Types
71226	8	Cool White	12V - 90	Ø 35mm 37mm	 G 4	 MR11









## LED Bulb, Multiuse, 10-28V DC

Code	LED Colour
31386	Green
31387	Red



## LED

	Code	LED / SMD	Colour	Volt - Lumen	Dimensions (mm)	BASE TYPE						
						BA9S	SV8.5-8	BA15S	BAY15D	BA15D	G4	W2,1X9,2d
	71227	8 SMD (2x4)	Cool White	12V - 60	11 x 39		•					
	71228	18 LED		12V - 90	15 x 39			•				
	72411											•
	71229	4 SMD + 1 LED		12V - 37,5	9,2 x 29,5							•
	71230	36 LED		12V - 270	15 x 52,5				•			
	71231	21 LED		12V - 157,5	40 x 30 x 8,2						•	
	71232	4 LED PIRANHA		12V - 30	37 x 25 x 8,2						•	
	71233	4 SMD + 1 LED		12V - 37,5	9 x 25,5	•						
	71234	4 LED	12V - 30	11 x 41		•						

## INCANDESCENT BULBS

	Bulb Code	Volt-Watt	Dimensions (mm)	BASE TYPE								
				BA9S	SV8.5-8	E 10	BA15S	BAY15D	C-2R	C-6U	C-81	CC-81
	00438	12V - 25W	15 x 65						•			
	30570*											
	00439	24V - 25W	25 x 67						•			
	30580*											
	00440	12V - 10W	15 x 65						•			
30590*												
	00386	12V - 10W 41mm	11 x 41		•							
	30600*											
	00568	12V - 10W 38mm	11 x 38		•							
30610*												
	00757	4,8V - 3,6W	9 x 28			•				•		
	30650*											
	00453	1,1V - 0,33W	9,5 x 23			•					•	
	30640*											
	00420	12V - 10W	15 x 34				•				•	
	30630*											
	01184	12V - 5W	10 x 29	•							•	
	30940*											

\*Blister

Bulb Code	Volt-Watt	Dimensions	BASE TYPE	FILAMENT TYPES
				
02020	12V - 20W	Ø 50mm		





## Interior Equipment & Galley



Barbecues & Accessories	349-350	Weather Instruments & Clocks	356-357
Gas Control Valves & Cylinders	350	Marine Ashtrays	357
Cookers & Hobs	351-352	Marine Fans	357
Coolers	352	Mosquito Repellent	357
Dinnerware, Cutlery & Beverageware	353	Nautical Gifts	357
General Use Cases	354-356		

Find out all the accessories you need to make the interior space of your boat more comfortable, cozy and enjoyable. Choose within a plenty range of products that suit your decorating style such as weather instruments & clocks, Teak products, buoyant deck cushions, multi-function tools.

At MARINA Stores you can also find all the necessary equipment for your boat's cabin and galley, in order to be prepared for any occasion, just like when you are at home. Discover a variety of products such as: hobs, electric coolers, isothermal coolers, dinnerware, beverage ware & flatware.



### Gas Barbecue "Marine Kettle 2", Inox

"Marine Kettle 2" Gas barbecue will be your offshore perfect mate for on-board and on-shore delight. You can use it as a grill, stove or oven due to its stainless steel diamond shape. Heat is distributed evenly within "Marine Kettle 2", grilling food smoothly. Additionally the notated, radiant plate underneath the barbecue, makes it resistant to bad weather conditions. There is a control valve regulator on the right side of the barbecue, where you can connect the gas canister (70134) or the propane/butane of your boat. However, you will need a low-pressure control valve (70116) to connect the main propane/butane system of your boat with the barbecue. What is special about "Marine Kettle 2" is its windproof turbo venturi system, directly lucked to the control valve regulator, which eliminates any gas leakage. Pressing the red start up button on the front of the barbecue "Marine Kettle 2" is activated, whereas the control valve regulator adjusts temperature. The rack of "Marine Kettle 2" lies on a burning bell shaped plate shielded by an outer cover. The gap between the two parts isolates heating within the barbecue area keeping its outside surface warm. The cool handle of the barbecue allows you to supervise cooking, at all times "Marine Kettle 2" complete disassembly allows quick and easy cleaning. This barbecue rests on particular mounts either on the rails of your boat (70123, 70124 or 70125) or on flat surfaces onshore is activated (70126).



Code	Diameter
70113	381mm (15")



### Gas Barbecue "Marine Kettle", Inox

"Marine Kettle" gas barbecue is an economic solution for your sailing and/or coastal pursuit. It is both a grill and a stove appropriate for windy climate conditions. The diamond shape of the barbecue allows equal heat distribution the entire grilling area, broiling food smoothly, while the radiant cover above burner sends grease aside. Under the stainless steel barbecue cabinet lays a revolving metal plate, which reduces wind effects. There is a cool handle on the lid of "Marine Kettle", which allows you to supervise food while grilling. The proper fuel for "Marine Kettle" is either a gas canister (70134) or the main propane/butane flow of your boat. Alternatively, it could be directly connected to the control valve regulator on the right side of the barbecue. For propane/butane fuel you need to use a low-pressure control valve (70116) to achieve connection with the barbecue. Control valve regulator activates "Marine Kettle" and adjusts its temperature. You can arrange fuel distance from the barbecue and eliminate gas blowouts through the wind turbo venturi system, which is between the barbecue cabinet and the control valve regulator. "Marine Kettle" complete disassembly is simple to enable fast cleaning. This barbecue could be placed on the rail of your boat or on shore using mounts 70123, 70124, 70125 or 70126 respectively.



Code	Diameter
70114	381mm (15")

### Gas Barbecue "ChefsMate" with 1 Pack, Inox

"ChefsMate" barbecue appeals to on-board and on-shore adventure. It comes with portable base, which is ideal for use onshore, while you can use base 70120 or 70121 for mounting the barbecue on the rails. The latter is sold separately from the barbecue. "ChefsMate" is made of brilliant stainless steel with tight fastened lid and funnel bottom shape. Thus, food is grilled smoothly over its single rack. "ChefsMate" functions either with gas canister (70134) or with the main propane/butane flow of your boat. Both the gas canister and the propane/butane flow are adjusted to the control valve regulator, on the right side of the barbecue, in order to start the barbecue up or adjust its heat. Should you prefer to use the propane/butane system of your boat, you will need to use an extra low-pressure control valve (70116). The rack can be easily removed for an easier cleaning of the "ChefsMate".



Code	Grilling Area	Rack Dimensions	
		Width	Length
70112	1.045cm <sup>2</sup> (162 sq. In.)	23 cm / 9"	46 cm / 18"



new

MAGMA

## Charcoal Grill, "Marine Kettle", Inox

The time tested original charcoal Marine Kettle® grill now has a hinged lid. Made in the U.S.A., it is meticulously crafted of 100% 18-8 mirror polished stainless steel for maximum corrosion resistance. Its rotating design allows you to determine which direction you would like the lid to open when grilling in windy conditions. You obtain perfect results through use of the adjustable height cooking grill and the variable temperature control draft door assembly. The Marine Kettle® design allows oven type baking to enhance the grill flavor while retaining the natural juices of the food. It will cook more food faster, on less grill area, than any other charcoal grill. Safety and efficiency are obtained by closing the draft door and extinguishing the coals for future use.

Code	Diameter
74440	381mm (15")
74441	432mm (17")

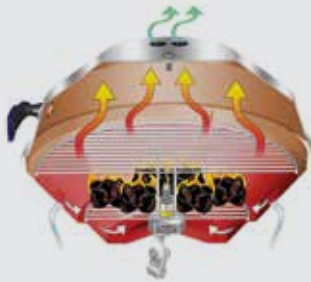

Interior Equipment & Galley



Round Rail Mount



"L" shaped mounts for the horizontal support of "Marine Kettle" and "Marine Kettle 2" (70113 & 70114) on your boat rails. They are easily emplaced and removed without tools. Made of stainless steel and aluminum.

Code	70123	70124
For Round Rail Ø mm (In.)	22-25 (7/8"-1")	29- 32 (1 1/8"- 1 1/4")



Dual Horizontal Round Rail Mount



Dual mounts for the stiff horizontal support of "ChefsMate" barbecues (70112) on boat rails. They are easily emplaced and removed without tools. Made of stainless steel and aluminum.

Code	70120
For Round Rail Ø mm (In.)	22-25 (7/8"-1")



Single Horizontal Round Rail Mount

Single mounts for the horizontal support of "Chefs-Mate" barbecues (70112) on boat rails. They are easily emplaced and removed without tools. Made of stainless steel and aluminum.

Code	70118
For Round Rail Ø mm (In.)	22-25 (7/8"-1")

## Gas Control Valves & Cylinders



Low-Pressure Control Valves for Onboard System (onboard propane or CampinGas butane)

Connects the propane/butane fuel provision of your boat with the control valve regulator of "Marine Kettle", "Marine Kettle 2", "ChefsMate" and "Catalina" barbecues.

Code	70116
For Barbecues	70113, 70114, 70112



Code 70128

Control Valve Regulator, Type 2, Low Output

Connects the gas canister or propane/butane fuel valve with Magma barbecues. It facilitates fuel exchange and adjusts grilling temperature.

MAGMA

Butane Canister Campingaz CV-470 Plus



Code 70134





**Cooker with Oven & Burners**

Central position oven burner on models 97846 and 97847 for perfect horizontal heat distribution. The hob burners have a different output for maximum cooking flexibility and for saving fuel. Extra large capacity hob to enable the use of big pots. Easy cleaning extra large oven tray (900cm<sup>2</sup>) and large grid. Exclusive double tray system inside the oven on models 97846 and 97847. Safety device on the burners provide 100% gas shut-off should the flame ever be extinguished. Each burner has precise flame adjustment. Automatic door locking device and gimbals stop. Slide adjusting pan holders. Double tempered glass oven door.

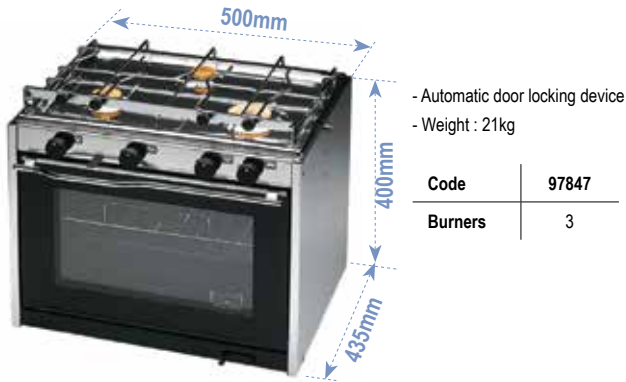

- Automatic door locking device  
- Weight : 21kg

Code	97847
Burners	3



Code	97846
Burners	2

**Cooker with Oven & 2 Burners**



Code	97848
Weight (kg)	21

**Cooker w/ Oven, 2 Burners & Separate Grill**

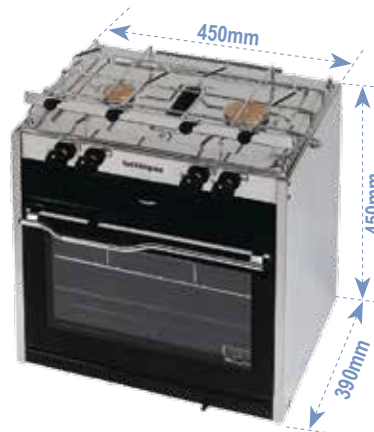

Code	97849
Weight (kg)	21

**Built in Hob with 2 Burners**



The hob burners have a different output for maximum cooking flexibility and in order to save fuel. The burners are arranged on the hob so that you could use several pans simultaneously. Turbo slimline burners with technologically advanced design and precise flame adjustment. Flame failure devices on all the burners. The appliances can be finished in stainless steel or top grade vitreous enamel.

Optional: heat guards (made of durable stainless steel) and slide adjusting pan holders, glass lids with brakes and hinges, electronic ignition.

Code	97853
Burners	3KW
Weight (kg)	2,5
Height (mm)	65

**Built in Hob with 3 Burners**

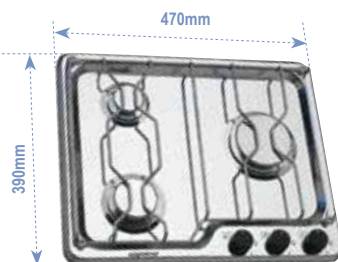

Code	97854
Burners	3KW
Weight (kg)	3,5
Height (mm)	65

**Gas Hob-Unit**



Code	95895
Width (mm)	320
Depth (mm)	285
Ext. Height (mm)	30
Int. Height (mm)	100



## Cookers & Hobs

### Gas Cookers

Attractive styling with Italian design. Safety device on all burners. The stoves are available with the options of deep fiddle rails, slide adjusting pan holders and gimbals. New battery operated electronic ignitions are available. Each burner has precise flame adjustment. Pan support racks are easy to remove for cleaning.

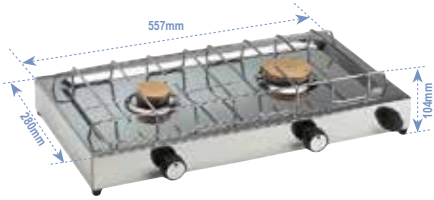

**Cooker with 2 Burners**  
Weight : 3 kg

Code | 97850\*



**Cooker with 1 burner**  
Weight : 2 kg

Code | 97851\*

\* Installation fittings are included.

## Coolers



### Portable Isothermal Cooler

The SeaCool Portable Isothermal Cooler is suitable for all of your excursions. Elegant shaped with practical interior design, it can be ideally used in the boat, camping, picnic and anywhere you need a cooler with no electric function. Made of solid polyurethane foam it features high performance insulation in order to maintain the temperature of the contents. For even better performance it is suggested to fill it with ice. The Portable Isothermal Cooler is available in 3 different sizes of 13lt, 48lt & 80lt. They are equipped with large handle(s) for easy carriage, while the 80lt cooler is supplied with ice caps.



Code	70989
Capacity (lt)	80
Length (cm)	82
Width (cm)	41.5
Height (cm)	40



Code	31378
Capacity (lt)	48
Length (cm)	63
Width (cm)	33
Height (cm)	37



Code	31377
Capacity (lt)	13
Length (cm)	38
Width (cm)	22
Height (cm)	37.5

Interior Equipment & Galley



### Marine Quart Ice Chest

Code	99078	99079	99080	99081	99082
Capacity (lt)	23.7	34.2	45.5	51.3	68.4
Length (cm)	51	61.6	64.5	64.8	72.6
Width (cm)	28.6	34.5	37.5	39.4	41.9
Height (cm)	33.4	33	36.5	39.4	41.9



### Quick & Cool

Code	99201
Capacity (lt)	95.1
Length (cm)	89.7
Width (cm)	44.1
Height (cm)	42.5



### Spare Door Fastener for Igloo Coolers

Code | 90164



### Spare Hinge for Igloo Coolers (2 pcs)

Code | 70974



**EXCLUSIVE**

**“Exclusive” Range**

With the Sea Tableware “Exclusive” range of plates, glasses and cutlery, you and your friends will enjoy every bite and sip of your meal. If the words sophisticated, chic and stylish are part of your attitude and life style, then the “Exclusive” range is just for you. The dinnerware range of plates, bowls, serving sets, cups and mugs gives all you need for an enjoyable breakfast, lunch and dinner. All items are made of 100% melamine and can be used in a microwave without any problem. For all the special celebrations, the Sea Tableware “Exclusive” range includes shiny and stylish wine, champagne and water glasses to enjoy your drinks. You can also impress your guests with the elegant wine cooler, ice bucket and pitcher. Glasses are made of acrylic material, which does not break or chip. Finally, Lalizas offers you cutlery sets, made of stainless steel 18/10 with ABS handle, including forks, spoons, knives and teaspoons. All glasses and plates, except for the salad and the soup bowl, are available in sets of 6 pieces, whereas the cutlery in 24pieces. Thanks to their top quality materials and construction, all items in the “Exclusive” range are light, shock resistant, completely hygienic and especially designed to retain their original beauty and shine even after many uses.



**Dinner Plate Set, Ø 26cm  
“Exclusive”, 6 pcs**

Code | 57210



**Side plate set  
“Exclusive”, 6 pcs**

Code | 57212



**Soup Plate Set, Ø 23cm  
“Exclusive”, 6 pcs**

Code | 57211



**Soup Bowl with  
cover “Exclusive”**

Code | 57215

**Salad Bowl Ø 24cm,  
“Exclusive”**



Code | 57213

**Cereal Bowl Set,  
Ø 15cm, “Exclusive”,  
6 pcs**

Code | 57214



**Cutlery Set  
“Exclusive”,  
18/10 s.s./ABS,  
24pcs**

Code | 57208



**Mug Set  
“Exclusive”, 6 pcs**

Code | 57218



**Wine Glass Set,  
“Exclusive”, 4 pcs**

Code | 72153



**Glass  
“Exclusive”,  
4 pcs**

Code | 72150



**Water / Beverage  
Glass  
“Exclusive”, 4 pcs**

Code | 72152



**Espresso Cup Set  
“Exclusive”, 6 pcs**

Code | 57217

**Set of 17  
pcs**



**Dinnerware Set “Exclusive”, 17 Pieces**

- Included:**
- Dinner Plates, Ø 26cm (4pcs)
  - Dessert Plates, Ø 20cm (4pcs)
  - Cereal Bowls, Ø 15cm (4pcs)
  - Mugs (4pcs)
  - Salad Bowl Ø 24cm (1pc)

Code | 57350



### Horizontal Mounting

- Easy to mount
- Various mounting options

**For all "Store-All" cases**

1. With screws

2. With fixed mount support base (99826-7)

### Vertical Mounting

1. With screws

2. With fixed mount support base (99826-7)

3. With rail support base (99824-5)

## Store All Isotherm Cover for Drinks

Whether you like your coffee to stay hot in the winter or your refreshments cold in the summer, this cover is a 'must-have' for you. It is manufactured in such a way that your beverage will be at the same temperature (hot or cold) longer than it would be without. It has been designed to easily cover most common cans or cups. It can be fitted in the various Store-All drink holders (94144-5, 94161, 99232).



Code	99828
Colour	Blue
Ext. Diameter (cm)	8.1
Height (cm)	10
Internal Diameter (cm)	6.5



## Store-All Drink Holder

This compact and convenient cockpit saver keeps your drinks up and out of the way. You can place it on any smooth surface, by using the support base (99824-7) on the back or bottom of the holder. Available in white and graphite colour.



Code	94161	99232
Colour	White	Graphite
Length (cm)	11	
Width (cm)	11	
Height (cm)	10	
Internal Diameter (cm)	9 / 9,3	
Internal Height (cm)	9	



## Store-All VHF/FRS Case

With the VHF/FRS case you can keep your communication devices safe and within easy reach. Due to its small size, it can even fit close to the helm of the smallest boat. In order to mount the case, you can place the support base (99824-7 - not included) either on the back or on the bottom of the case. The case is available in white colour.



Code	94152
Colour	White
Length (cm)	13,5
Height (cm)	11,5
Width (cm)	8
Internal Length (cm)	9



## Store-All Galley Case

This handy case is suitable for keeping your sponges, brushes, sun-block or any small object organised. It is easily mounted using the special support base for cases (99824-7 - not included), which can be placed on the wall, on the console or on the rails. It is available in white colour.



Code	94160
Colour	White
Length (cm)	19
Height (cm)	10
Width (cm)	11,3
Internal Length (cm)	14,3



## Store-All GPS/Cell Phone Case

Ideal for storing most hand-held GPS and mobile phones. It can be placed vertically or horizontally on any flat surface, by using the support base for rails and surfaces (99824-7), which allows you to remove the case easily and fast. Available in white colour.



Code	94150
Colour	White
Length (cm)	18,5
Height (cm)	10,5
Width (cm)	9



## Store-All Organiser & Drink Holder

This is perfect for you, if there are not any storage cases for small objects on board. It features drink holder and a case to hold sunglasses, sunblock etc. It is easily mounted either vertically or on a flat surface, using the support base for rails or level surfaces (99824-7), which allows you to remove the Organizer anytime. Available in white colour.



Code	94144
Colour	White
Length (cm)	26,5
Height (cm)	10
Width (cm)	11





### Store-All Folding Drink Holder

Ideal for small boats or areas with very limited space. Its folding feature allows you to completely retract it when you do not use it. It features adjustable arms to hold cans and mugs and also screws for permanent mounting. This drink holder can also be mounted on the rails or against any surface, using the relevant support base (99824-7), which allows you to remove the holder when not in use. Available in white and graphite colour.

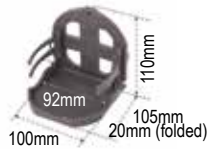

Code	96866	99230
Colour	White	Graphite
Height (cm)	11	
Length (cm)	10	
Width (cm)	10,5	
Internal Length (cm)	9,2	

### Store-All Folding Helm Organiser

When space is very limited on the deck and you have no room to leave small objects like sunglasses, keys or your drink, then all you need is this organiser. Its mechanism allows you to use it only when needed and fold it when you do not. It features a drink holder and inox screws for permanent mounting. However, you can also mount it using the support base (99824 - 5), which allows you to completely remove the organiser anytime. Available in white and graphite colour.



Code	96865	98591
Colour	White	Graphite
Length (cm)	25,8	
Height (cm)	11	
Width (cm)	10,5	

### Store-All Utility Hook, Set of 2 pcs

Ideal for multiple uses on board. You can place it on a flat surface of your boat and use it to tie lines, hang clothing or towels, etc. It is available in a pack of two, in white and graphite colour. Made of plastic.



Code	94126	99231
Colour	White	Graphite
Length (cm)	2.5	2.5
Height (cm)	7.5	7.5
Width (cm)	3	3



### Store-All Trash Bag Holder

Keep your cockpit and cabin tidy and clean. This holder can be easily mounted on any flat and even surface, with the use of the support base for rails or level surfaces (99824-7), so that you can store it easily and quickly. Its cover prevents the contents from falling out of the bag. You may use common supermarket bags or kitchen trash bags. Available in white colour.

Code	94146
Colour	White
Length (cm)	28
Height (cm)	6.5
Width (cm)	13,7



### Rail Support Base for Store-All Case

This support base allows you to mount semi-permanently the Store-All cases on the rails. All you have to do is mount the support base on the rails and then slide the case in. When you do not want to use the case, just remove it. The support base will remain on the surface for as long as you want it. Available in white and graphite colour.

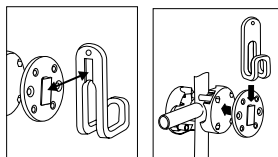

Code	99825	99824
Colour	White	Graphite
Diameter (cm)	6	
Width (cm)	4,5	

### Fixed Mount Support Base for Store-All Case

This support base allows you to mount the Store-All cases semi-permanently. All you have to do is to mount the support base on the surface you want and then slide the case in. When you do not want to use the case, just remove it. The support base will remain on the surface until the next time you need it. Available in white and graphite colour.

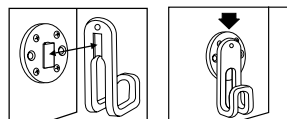

Code	99827	99826
Colour	White	Graphite
Diameter (cm)	6	
Thickness (mm)	9	

### Case 'Store-All' with Net and Plastic Frame,

It is ideal for organising all your belongings when on board with the help of a flexible holding net. Made of UV-resistant plastic, it provides resistance to damage and chemical solvents. Can be easily installed on your boat either with screws or with a sticker (supplied), appropriate for inflatable and rigid boats. Available in white colour.



Code	Colour	Thickness (mm)	Height (mm)	Width (mm)
11900	White	20	120	205
11901		10		



## General Use Cases



### Clip-on CAN HOLDER

This is a unique and useful accessory, ideal for holding and keeping cool cans, small bottles, and glasses. It is one-piece made and there is no need for extra parts. It preserves the temperature levels of the mounted object. It can also be used as an object holder for mobile phones, eye - glasses, portable VHF and GPS, etc. It is made of Flexible Integral PU Skin Foam technology and can be clipped on all guardrails, pulpit and stanchion, making it an essential accessory on board.



○ 470089

● 197762

GUARDRAILS Ø (mm)	L (mm)	W (mm)	H (mm)	⊕ (kg)
22-26	130	90	100	0,25

### ALVEA Drinks Tray

ALVEA is a unique and useful glass and bottle tray, made of Flexible Integral PU Skin Foam technology and non-slip material. Thanks to the moulded design, the cups - either plastic or glass - are held firmly even when they are empty or during strong winds, making ALVEA an essential accessory on board. In addition, it keeps the table tidy and it's easy to clean, by using only soap and water.



● 473084

L (mm)	W (mm)	H (mm)	⊕ (kg)
270	230	50	0,3



## Weather Instruments & Clocks



Barometer & Clock, Ø100mm, Brass, Mahogany Base

Code | 91716



Barometer, Thermometer & Hydrometer, Ø70mm

Code | 91718



Barometer, Clock Quartz & Thermometer, Ø70mm

Code | 91719



Thermo/Hydrometer Tempo, Brass, Ø70mm

Code | 71187



Barometer Tempo, Brass, Ø70mm

Code | 71183



Clock Quartz Tempo, Brass, Ø70mm

Code | 71185



Barometer Tempo, Chrome, Ø70mm

Code | 71184



## Weather Instruments & Clocks



**Clock Quartz Tempo, Chrome, Ø70mm**

Code | 71186



**Thermo/Hydrometer Sky, Inox, Ø85mm**

Code | 91715



**Barometer Sky, Ø85mm**

Code | 91713

## Marine Ashtrays

Code	Description
90752	Ashtray, Inox 304, Ø10cm & H:5cm, Blue



**Ashtray**

## Marine Fans

Code	Description
94550	Marine Fan, 12V - 1,4A
94551	Marine Fan, 24V - 0,7A



**Marine Fan**

This fan is suitable for circulating air on board. It is available in 12V and 24V. The blade draws 1,4A at 12V and 0,7A at 24V. Dimensions: L. 161mm W. 180mm H. 237.5mm

**Dimensions:**  
L 161mm W180mm H 237.5mm

## Mosquito Repellent



**Mosquito Repellent Mat Heater 12V, with Car Plug Cable**

Code | 71284

## Nautical Gifts



**Keychain Buoy**

Code	72448	72541
Colour	Red	White



**Keychain Fender**

Code	72540	72447
Colour	Red	White



**Key-Ring Floating**

Code | 44526



**Key Holder-Cork, Floating, Round**

Code | 71963



# Watersports & Fishing



SUP & Accessories _____	359-360	Wetsuits _____	370
Towable Tubes & Accessories _____	361-365	Diving & Sports Buoys _____	371
Tow & Ski Ropes _____	366	Diver's Knives _____	371
Sound on Board _____	367-368	Utility Cases _____	372
Water Sports Personal Gear		Aquascope _____	373
& Pool Floats _____	368-369	Fishing Rod Holders _____	373-374
Dive Masks & Snorkels _____	369-370	Fishing Accessories _____	374-376
Fins _____	370	Surface Floats _____	376

Do you love watersports? Increase the adrenaline rush with a ride on a Ski-tube! The wide range of WOW products will give you the most amusing way to enjoy the sea this summer.

Do you enjoy canoe-kayak, SUP, skiing or snorkeling? The Stand Up Paddle, Hercules 320 board, is the perfect way to explore nearby beaches and exercise!

At MARINA Stores you can also find an efficient fishing equipment so you can have the best possible experience in fishing whether it's for leisure or professional purposes.





**new**

**ARIMAR SUP Inflatable Board,  
Length 3,2m, with Paddle & Foot Strap**



**Specs:**

- Weight 10,2 kg
- Pressure 12-15 psi
- Drop stitch technology - allows the SUP to maintain its shape when it is inflated to high pressure
- Double Layer Fusion technology
- PVC coated fabric

**Hydrodynamic & modern design**

**Maximum Load 190 kg**

**Removable fins**

**Code | 501839**



**Combine with  
Buoyancy Aids  
page 20-22**

**Package Includes**



Watersports & Fishing



**HERCULES SUP Inflatable Board,  
Length 3,2m, with Paddle & Leash**

**HERCULES**



**Specs:**

- Weight 11,5 kg
- Pressure 12-15 psi
- Drop stitch technology - allows the SUP to maintain its shape when it is inflated to high pressure
- Double Layer Fusion technology
- PVC coated fabric
- Modern design
- Ideal for beginners and intermediate users
- Maximum Load 120kg

Removable fins



**Combine with**  
Buoyancy Aids  
page 20-22

Code | 73117

**Package Includes**



**Hercules Sup Paddle 210cm**

- Folding for easy transportation and storage
- Made from aluminum material
- Special SUP handle
- Just 1 kg weight for extended use

Code | 72307

Watersports & Fishing



Ski Tube,  
THRILLER 1p,  
127x122cm

Code | 72817



Ski Tube, BIG THRILLER  
2p, 152,4x142,24cm

Code | 72824



Ski Tube,  
SUPER THRILLER 3p,  
190x157cm

Code | 72818



Ski Tube,  
GIANT THRILLER 4p,  
228,6x167,64cm

Code | 72827

Watersports & Fishing





Ski Tube,  
ACE RACING,  
127x122cm

Code | 72821



Ski Tube,  
BIG BOY RACING,  
175,26x175,26cm

Code | 72826



Ski Tube,  
WILD WING 2,  
172 x 168cm

Code | 73148



Ski Tube,  
WILD WING 3,  
228 x 183cm

Code | 73149





Ski Tube,  
ZIG ZAG,  
152x137cm

Code | 72819



Ski Tube,  
COUPE COCKPIT 1p,  
146x94x66cm

Code | 72825



Ski Tube,  
COUPE COCKPIT 2p,  
152x147cm

Code | 72820



Ski Tube,  
HOT LIPS,  
172x170x71cm

Code | 72834

Watersports & Fishing





Ski Tube, UTO GALAXY 2, Ø152 cm

Code | 73147



Ski Tube, JET BOAT 3p, 302x95cm

Code |

Code | 72822



Ski Tube, Big Shark 2p, 327x158cm

Code | 73727



Watersports & Fishing



Ski Tube,  
SUMMERTIME 2,  
152 x 142 cm

Code | 73153



Ski Tube,  
SUMMERTIME 3,  
193 x 158 cm

Code | 73154



Ski Tube,  
XO EXTREME 3p,  
213,36x177,8x162,56cm

Code | 72836

Watersports & Fishing





### Tow Rope 2K, 18,3m

- Length 18,3m
- Break Strength 2375 Pound / 1.080 Kg
- To tow any tube up to 2 Riders
- (3/8") 9.5mm
- 12 strand rope construction

Code | 73155



### Tow Rope 4K, 18,3m

- Length 18,3m
- Break Strength 4100 Pound / 1.860 Kg
- To tow any tube up to 4 Riders
- (5/8") 15mm
- 16 strand

Code | 73156



### Tow Rope 6K, 18,3m

- Length 18,3m
- Break Strength 6100 Pound / 2.770 Kg
- To tow any tube up to 6 Riders
- (3/4") 19mm
- 16 strand rope construction

Code | 73157



Watersports & Fishing

### Ski Rope

\*Handle is not detachable



Code	92889
Description	"Water Action"
Length	23m
Diameter	8mm (5/16")
Strength	771kg
Strands	16
Handle's Length	33cm (13")
Handle's Material	Aluminium with rubber
Handle's Colour	Black



### Ski Rope

\*Handle is not detachable



Code	92888
Description	"Professional"
Length	23m
Diameter	10mm (3/8")
Strength	1077kg
Strands	16
Handle's Length	33cm (13")
Handle's Material	Aluminium with rubber
Handle's Colour	Black

### Transom Mount Ski Tow



Code	90754	90755
Length Thread	50mm	
Diameter	63mm	76mm



### Steering Puley

Code	99577
Overall Diam.	92mm
Rope Diam.	6,4mm





**Sound Speaker, Bluetooth, Floatable, Waterproof IP67, 4.1 - 50W, 50h Bat.Life, Orange**

- IP 67 Waterproof for up to 30 minutes at a depth of 1 meter
- Four 2 inch active speakers and one 4 inch passive bass for a great balanced sound with sweet highs and deep lows
- Connects with any Bluetooth-enables mobile device, including your iPod, iPhone, iPad or Android device
- Audio: Maximum Sound Level: 100dBA
- Rechargeable Lithium-Ion Battery for up to 50+ hours of battery life
- 360° LED light for nighttime use comes with bright, brighter, brightest settings
- Connect more than one WOW-SOUND SPEAKER together for an even greater sound
- Includes inflatable Speaker Float so you can use it on any type of water pool or lake.
- Includes waterproof floating phone holder

Code | 73158



**SOUND BUOY Speaker, Bluetooth, Floatable Water-proof IP67,20h Bat.Life, Yellow**

- IP67 Waterproof for up to 30 minutes at a depth of 1 meter
- Connects with any Bluetooth-enables mobile device, including your iPod, iPhone, iPad or Android device
- Rechargeable Lithium-Ion Battery Over 20+ hours of battery life
- 360° LED multi- colour light
- Connect more than one WOW-SOUND SPEAKER together for an even greater sound

Code | 73160



**Waterproof Radio/MP3 Player 4x20Watt - LCD - AUX - Bluetooth**

Marine USB/MP3 Player, Black, Radio AM/FM, Output auxiliary 4x20Watt, Clock, Input AUX, Green-lighted/LCD high resolution display.

- Marine USB/MP3 Player
- Radio AM/FM
- Clock
- Fully waterproof-complies with the instructions ASTM B117 Salt/Fog exposure & ASTM D4329 UV
- Water-tight/high quality rubber buttons,
- Possibility of support behind the console

**Dimensions:**  
front diameter 87mm, hole diameter 76,5mm, depth 58mm

- Package Includes:**
- 1 Audio source
  - Mounting bracket with fixing screws
  - Connection cables for speaker
  - USB Cable - 1m
  - User Manual

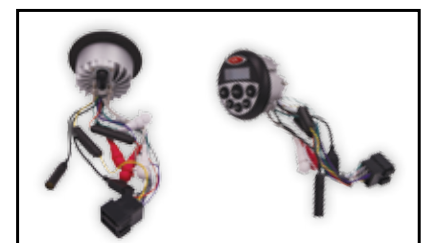
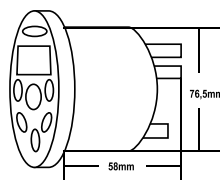
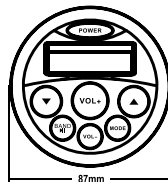

Code | 63765



Watersports & Fishing



**new**

**Two-way Speakers, 100W, 6 1/2", Non-magnetic, with Clip-on Cover, White, Set**

Ideal for use in boats, the Two-way Speakers are waterproof and corrosion-resistant while they can be hosed down when the boat is being cleaned. Having non-magnetic design, they don't disturb instruments or compasses and their ASA cover provides improved endurance in both sea and sun exposure. They also feature waterproof and corrosion-resistant mica injection cone with TPU edge and corrosion-resistant silicone coated terminal wire. Can be mounted either horizontally or vertically. Suitable for indoor and outdoor use. Available in white colour. CE approved.

**Technical Specifications:**

- Impedance: 4 Ohm
- Sensitivity: 90 dB
- Frequency Response 60-18000 Hz
- Max Power 100W (per pair)
- RMS Power 80W (per pair)

**Mounting Dimensions:**

- Depth: 64mm
- Hole diameter: 136mm
- Magnet: 350g (8oz + 4.3oz)



Code | 74576

To remove the cover, turn it on the left



**2 Way Speaker Set**

With Nuova Rade Speakers installed in your boat, you can relax or party - listening to your favourite music. Ideal for use in boats, since they are water (31302 & 31303) and corrosion proof. The 2-way speakers may be mounted both indoors and outdoors.

**Technical Specifications**

**31302**

- 5 1/4" 2 Way Speaker Set 80W
- Impedance: 4 Ohm
- Sensitivity: 88db
- Frequency Response: 80-18000 Hz
- Max: 80W (per pair)
- RMS Power: 70W (per pair)
- Material: UV-stabilised ABS plastic
- Dimensions: 5,25" (13,34cm)

**Mounting Dimensions**

Depth: 53mm, Hole: 115mm  
Magnet: 238g (5.4oz + 3oz)

**31303**

- 6 1/2" 2 Way Speaker Set 100W
- Impedance: 4 Ohm
- Sensitivity: 90db
- Frequency Response: 60-18000 Hz
- Max: 100W (per pair)
- RMS Power: 80W (per pair)
- Material: UV-stabilised ABS plastic
- Dimensions: 6,5" (16,5cm)

**Mounting Dimensions**

Depth: 64mm, Hole: 136mm  
Magnet: 411g (8oz + 6.5oz)



Code	31302	31303
Diameter (Inches)	5' 1/4"	6' 1/2"
Power (W)	80	100
Colour	White	White

Watersports & Fishing

**Water Sports Personal Gear & Pool Floats**



**Swimming Goggle, with Antifog lens, Silicone eyecups & strap, black**

Code | 90361



**Junior Swimming Goggle, w/ Antifog lens, Silicone eyecups & strap, transparent black**

Code | 90363



**WOW POOL FLOAT 1p,**  
190,5x78.74cm

Code | 72830



**WOW Pool Float,**  
**WATER PICKLE,**  
122x14cm

Code | 72828



Dive Masks & Snorkels



**2 Window Black**  
**Silicone Mask with**  
**Tempered Glass**

Code | 98791



**PVC Mask with**  
**Tempered Glass,**  
**yellow-Black**

Code | 98755



**Silicone Mask, Dual Windows,**  
**with Tempered Glass, Junior,**  
**Yellow**

Code | 90355



**Combo Set with Silicone**  
**Mask & Silicone Snorkel,**  
**Black-Silver**

Code | 98759



**Junior Combo**  
**Set with PVC Mask**  
**& PVC Snorkel, Black**

Code | 98761

Watersports & Fishing



## Dive Masks & Snorkels

### Snorkel Mask, Full-Face, Blue

- 180° Viewing
- Combined mask & snorkel
- Easier breathing
- Pleasant snorkeling experience
- With camera mounting base

Code	Size
72658	S / M
72659	L / XL



180°  
Snorkeling



## Fins

### Flexible Fins, Black/Grey



Code	Size
90364	S (36-37)
90365	M (38-39)
90366	ML (40-41)
90367	L (42-43)
90368	XL (44-45)
90369	XXL (46-47)

## Wetsuits

**LALIZAS**

Watersports & Fishing



### Wetsuit Full Length Neoprene 3:2mm, Black

Full wetsuits are your winter sport garment for the sea. Your main body is covered with 3mm neoprene thickness, while your legs and arms are covered with 2mm neoprene thickness. Therefore, the neoprene suit keeps your body warm and offers you high degree of flexibility. Flatlocked seams, waterproof back zipper, adjustable neck and aqua stops at legs prevent water leaks and keep you warm. Wind resistance is provided to your chest and back, which are covered by an additional overlay of impermeable fabric. This wetsuit is equipped with special kneecaps and a hidden small pocket (at the back) for your keys.

Code	72555	70526	70527	70528	70529	70530	72556
Size	XS	S	M	L	XL	XXL	XXXL



### WETSUIT SIZING MEASUREMENTS

Dimensions are in cm

Size	XS	S	M	L	XL	XXL	XXXL
Height	162-170	167-175	175-181	181-187	184-190	187-193	190-196
Waist	67-73	70-76	74,5-80,5	83-89	87-93	91-97	95-101
Chest	89-89	89-95	94,5-100,5	102,5-108,5	107-113	111-117	115-122
Hips	85-91	88-94	92,5-98,5	101-107	105-111	109-115	113-119



**Diver Buoy**

It is ideal for diving with cylinders. It is easy for the diver to use, since it is especially designed so as to facilitate the diver's moves without jeopardizing his safety. The red buoy is folded and attached with a rope (6m) inside the blue case; the case has a sewn black plastic clip on, which offers the ability to the diver to fasten the buoy on his suit for easy carrying. Additionally, the case features a whistle to use in any emergency. The buoy is made of soft PVC, 0.3mm thick, while the case is made of 1000D Polyester with PVC film, 0.5mm thick.

**Instructions of Use**

Open the case and release the buoy. Use the cylinder to provide the buoy with a small quantity of air. In this way, the pressure of the air along with the pressure of the water will make the buoy to inflate and pop up on the water surface, warning the boats that a diver will soon float at the specific point.

Code	Dimensions (cm)	
	Packed	Inflated
70017	L20 x W8	H145 x W15



**Diver Down Flag**  
35 x 50 mm

Code | 67169



**Torpedo Diving Marker Buoy, "Safe Dive"**

diam. 28cm, length 88cm

Code | 97816



**Torpedo Diving Marker Buoy, Reinforced, "Safe Dive" with 20m Rope**

Code | 97813



**Round Marker Buoy "Safe Dive"**

diam. 30cm, height 50cm

Code | 97814

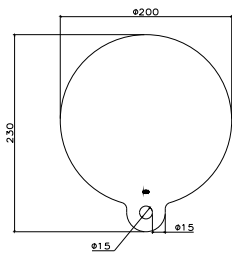

**Sports Buoy**

Sports Buoy is made of high-quality PVC material. This small but durable inflatable buoy is the perfect marker for a beach, a waterski course or any area that requires marking. OCEAN Sports Buoy meets the American Water Ski Association specifications. With a durable rope hold to fasten any line.

Code	Colour	L (mm)	H (mm)	Weight (kg)
72450	Red	200	230	0,6



Watersports & Fishing



**Diver's Knives**



**Diving Knife "Security", Stainless Steel, Blade: 11,5cm (4,5")**

Code | 61844



**Diving Knife "Discovery", Stainless Steel, Blade: 14,3cm (6")**

Code | 70198

*\*Provided with plastic case & elastic bands*

## Unbreakable Cases, Waterproof & Floating

These cases integrate simplicity & functionality in a minimal clear-top design, while being unbreakable and made of high-quality materials. No matter if you are in your boat, rock-fishing, sailing, performing outdoor excises, being on holidays or even in a business trip, Sea Shell cases will grant top safety for all your carry-on valuables, fishing gear, electronic devices as well as everything else you fit inside. Portable and very easy-to-use, these cases float in the water and are 100% water-resistant. They are also moisture-proof, dustproof (full seal vacuum design), keeping the content dry. Made of high strength compound materials and all-weather secure

### “LIFETIME GUARANTEE”

... are two individual words which best describe the high-performance\* waterproof Cases by SeaShell.



Code	71188	71189
Length (mm)		132
Width (mm)		100
Height (mm)		40
Colour	Blue	Yellow



Code	71190	71191
Length (mm)		182
Width (mm)		120
Height (mm)		42
Colour	Blue	Yellow



Code	71192	71193
Length (mm)		182
Width (mm)		120
Height (mm)		75
Colour	Blue	Yellow



Code	71194	71195
Length (mm)		224
Width (mm)		130
Height (mm)		46
Colour	Blue	Yellow

Watersports & Fishing



Code	71196	71197
Length (mm)		224
Width (mm)		130
Height (mm)		70
Colour	Blue	Yellow



Code	71198	71199
Length (mm)		224
Width (mm)		130
Height (mm)		88
Colour	Blue	Yellow



### Aquascope Jointed

- A high quality sturdy tool for viewing and observing the underwater aquatic life in seas, lakes and rivers
- Can be used for research or as an educational/entertainment tool
- Perfect for observing sea life and reefs, checking anchor hold, inspecting traps, locating bait, clam beds and schools of fish before casting your line
- The user can also locate lost items in the water without getting wet
- Made of high-quality PP material with a tempered glass bottom, surrounding grip and soft PVC rubber eyepiece on top
- It can be disassembled in 3 pieces making it easy to transport or storage
- Available in two colours: orange & black\*
- Can be used both from adults & children

*Ideal for fishing tournaments*

Code	31409	74689
Diameter (mm)	335	
Height (mm)	510	
Colour	Orange	Black



### Aquascope Mini

- A high quality sturdy tool for viewing and observing the underwater aquatic life in seas, lakes and rivers
- The mini size makes its storage and use easier
- Can be used for research or as an educational/entertainment tool
- Perfect for observing sea life and reefs, checking anchor hold, inspecting traps, locating bait, clam beds and schools of fish before casting your line
- The user can also locate lost items in the water without getting wet
- Made of high-quality polystyrene material with a tempered glass bottom, surrounding grip and soft PVC rubber eyepiece on top
- Can be used both from adults & children



Code	43350
Dimensions WxLxH (mm)	170 x 200 x 410

### Fishing Rod Holders

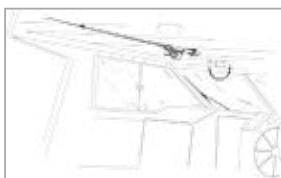

#### Holding Rings for Fishing Rod, Set

Code	Colour
44622	White
44623	Black



#### Storage Rack (Pair) for 3 Fishing Rods, White

White, Dimension 23x298x63mm

Code | 31529

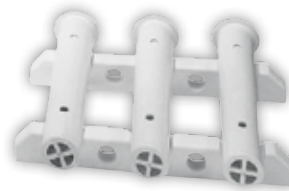

#### Storage Rack for 3 Rods, Bulkhead mounted, White

Length 300 x Height 225 mm

Code | 44512



#### Storage Rack (Pair) for 2 Fishing Rods, White

White, Dimension 23x222x63mm

Code | 31527



#### Rod Holder, Adjustable

- For fishing rod Ø 40 mm maximum
- Length: 21.5 cm
- Supplied with 2 sockets (for rails & bulkhead mounting)

Code | 37660



#### Socket, Side mounted, for 37660 Adjustable Fishing Rod Holder, Black

Code | 37795



#### Socket, Flush mounted, for 37660 Adjustable Fishing Rod Holder, Black

Code | 37796



## Fishing Rod Holders



**Fishing Rod Holder with Cap, Plastic**

Code	Int Diam (mm)	Height (mm)	Colour
37658	40	230	White
37659			Black



**Fishing Rod Holder, Plastic, Vertical**

Code	Int Diam (mm)	Height (mm)	Colour
98678	43	225	Black
98679			White



**Fishing Rod Holder, Plastic, Vertical**

Code	Int Diam (mm)	Height (mm)	Colour
44489	40	235	White
44490			Black



**Fishing Rod Holder, Side mounted, Plastic**

Code	Int Diam (mm)	Height (mm)	Colour
44501	40	235	White
44502			Black



**Rod Holder, Deck Type, Inox 316**

Code	96861
Surface	H.P.
Holder	Pipe
Body	Casting

H.P.= Hand polish

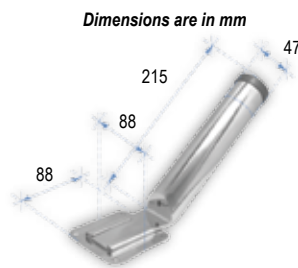

**Fishing Rod Holder, Removable, Inox 304**

Code	97035
Surface	H.P.
Holder	Pipe
Body	Casting

H.P.= Hand polish

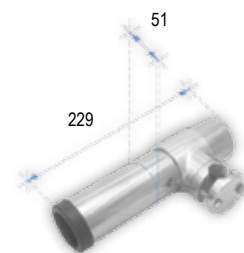

**Fishing Rod Holder, Rail mounted, Inox 304**

Code	97037
Surface	H.P.
Holder	Pipe
Body	Casting

H.P.= Hand polish

Watersports & Fishing



**Fishing Rod Holder, Inox, with Plastic White Cap**

Code	99136
Internal Diam.(mm)	38
Height(mm)	226



**Spare Cap for 99136, PVC, White**

Code | 90370



**Fishing Rod Holder, Inox 316**

Code	70666
Diameter (mm)	44,4
Length(mm)	195
Base Dimensions (mm)	80x59

**Four Fishing Rods Holder, Flush mounted, Inox 316**



Code	70619
Diameter (mm)	44,5
Dimensions (mm)	725x193

## Fishing Accessories

**Rope of Longline Fishing, Polyester**



Code	Diameter (mm)	Colour	Breaking Load in Kgs
71748	1	black	60
71749	2		110
71750	3		190







**Superline Braided, Dyneema 100%**

Ideal rope for small sailing boats like Optimist, Laser and other dinghies. Can be used as rope for spearguns, too.

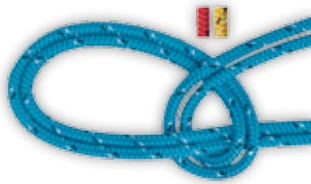

Code	Diameter (mm)	Colour	Breaking Load in Kgs
63452	1	red/black-white	100
63156	2	yellow/black-white	130
63453	3	blue/black-white	360



**Fishing Basket for Longline**

Code	Int. Diam. (mm)	Ext. Diam. (mm)	Height (mm)
45508	420	690	345
45509	340	520	195



**Needle for Fishing Net Splicing**

Code	Length (mm)	Width (mm)
43189	120	7
43191	120	10
43193	150	12
43195	175	13
43197	210	15
43199	230	17
43201	250	20
43203	280	23

**Container Rectangular for Longline**



Length: 495mm  
Width: 400mm  
Height: 100mm

Code | 43605



**Reel for Fishing Line Winding, Auto-Unrolling, Ø 165 mm**

Code | 43353

**Flashing LED White Light with Photocell, 1 Battery Size D, Torpedo 8**



White-colour flashing signal light with 5 super bright LEDs. Equipped with a photocell, working only during the night, while it switches off during the day. Uses 1 battery type D that last for 20 nights. Acid resistant rubber & o-ring waterproof opening. Durable plastic body with anti-tumbling protrusions and stainless steel spring on the inside.

Code | 63455

**Flashing LED Yellow Light with Photocell, Torpedo 8**

Yellow-colour flashing signal light with 5 super bright LEDs (flashes every 5 seconds). Equipped with a photocell, working only during the night, while it switches off during the day. It is visible up to 2 nautical miles and operates according to EU Regulation 404/2011 standard. Furthermore, it uses 1 battery type D that lasts for 20 nights. There is also an acid resistant rubber o-ring which ensures that the light is waterproof. The flashing signal light has a durable plastic body with anti-tumbling protrusions and stainless steel spring on the inside.

Code | 71297

**Flashing LED Red Light with Photocell, 2 Batteries Size D, Torpedo 1**



Red-colour flashing signal light with 5 super bright LEDs. Equipped with a photocell, working only during the night, while it switches off during the day. Uses 2 x D-type batteries that last for 20 nights. It has an acid resistant & waterproof rubber o-ring opening. Durable plastic body with anti-tumbling protrusions and stainless steel spring on the inside.

Code | 63454

**Watertight Air Pump, DC 3V, for Lures**

- Powered by two alkaline batteries type D
- Inox adjustable attachment clip



Code | 99807



## Telescopic Gaff with Anodised Aluminium Pole & Inox Hook

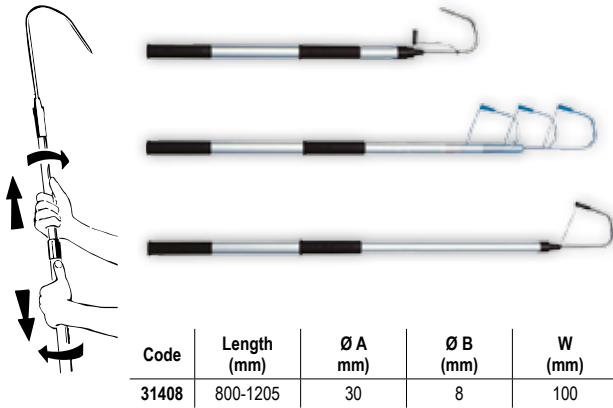

Code	Length (mm)	Ø A (mm)	Ø B (mm)	W (mm)
31408	800-1205	30	8	100

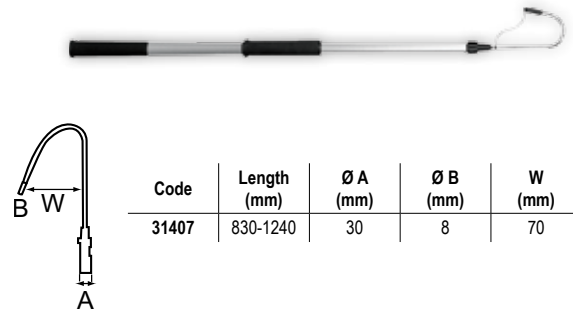

Code	Length (mm)	Ø A (mm)	Ø B (mm)	W (mm)
31407	830-1240	30	8	70

## Gaffs with Anodised Aluminium Pole & Inox Hook



Code	Length (mm)	Ø A (mm)	Ø B (mm)	W (mm)
44588	790	25	8	70
44590	1390			

## Gaff, Inox, with Plastic Grip

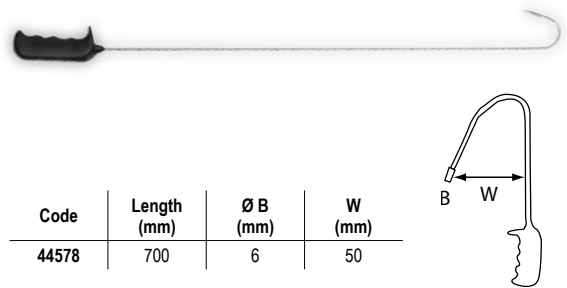

Code	Length (mm)	Ø B (mm)	W (mm)
44578	700	6	50

## Gaffs with Anodised Aluminium Pole & Inox Hook



Code	Length (mm)	Ø A (mm)	Ø B (mm)	W (mm)
44582	1370	25	8	100

# Surface Floats



## Surface Float with Hole, Spherical

Suitable for fitting marker flag.

Code	Colour	Diameter (mm)	Rope Diameter (mm)	Buoyancy	
				Overall (g)	In use (g)
43399	Yellow	190	19	1,8	0,9
16384	Orange				
16383	White				
43397	Yellow	260	28	8,5	4,2
16386	Orange				
16385	White				



## Surface Float w/ Hole, Cylindrical, White-Red

Dimensions: Ø 60 x 140 mm - Hole: Ø 10 mm.

Code | 16381

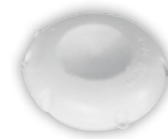

## Float for Fishing, Flexible, White Ø: 84 mm

Code | 43964



## Surface Float w/2 Eyelets, Spherical, White-Red

Dimensions: 15cm, Ø 13cm, top eye 1,2cm, weight: 130gr, Buoyancy: Overall 542gr, In use 271gr

Code | 43395



# Clothing & Accessories



In this category you can find a range of clothing products, ideal for marine conditions. They are waterproof, comfortable and durable.

You can also find useful accessories such as waterproof bags, sunglasses or hats.

Inshore Foul Weather Gear _____	379	Deck shoes _____	383
Workwear _____	380	Hats & Caps _____	384
Raincoat & Rainsuit _____	380	Gloves _____	384-385
Fishing Clothes _____	381	Dry Bags & Bags _____	385-387
Wetsuits _____	382	Sunglasses & Accessories _____	388
Boots _____	382-383		

# The Right Garment for You

## Fishing / Rainwear



If you need a garment with exposure to abrasion and chemicals, like fish blood or grease.

### Features

- The fabric has been PVC coated on both sides
- Stain Resistance
- Easy Cleaning
- Heat Welded Seams

Fishermen's Jacket & Trousers

## Sport Boating



If you need a garment for short, but constant trips and continuous use in possible rough conditions. Also, recommended for beginners, children and occasional sailors, as it keeps them dry. Easy to clean.

### Features

Depending on the model:

- PU or PVC coated Nylon Taslon and Taslon Oxford
- Medium weight for Durability
- Neoprene Cuffs
- Taped Seams
- Loops for Life jacket or Harness
- Hoods
- Retro Reflective Tapes
- Reinforced High Abrasion Areas

Inshore Sailing Jacket & trousers IT

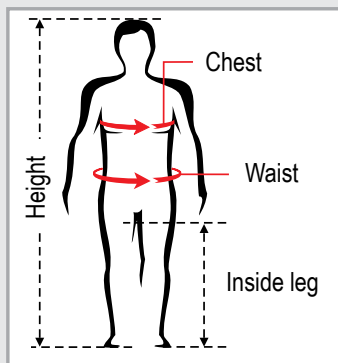
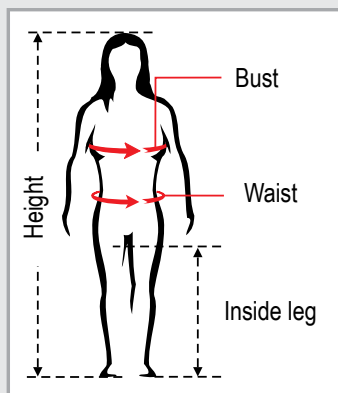

## Find your Size

### Universal Size Chart

Size	Height (cm)	Inside leg (cm)	Chest (cm)	Waist (cm)
JS	122	47-54	58-62	54-56
JM	134	54-61	62-66	56-59
JL	152	61-71	66-76	59-65
JXL/XS	163	71	76-86	66-72
S	168	76	94-99	84
M	175	79	102-107	91
L	183	84	109-114	97
XL	188	89	117-122	107
XXL	193	91	124-130	112

### Chest / Breast Circumference

Measure the circumference exactly under the armpits holding the tape steady at one point. For the breast line measure at the level of the largest circumference.

### Waistline

Measure around your waist holding the tape steady at one point.

### Inside Leg Length

Use a similar pair of trousers that fits you well and place it on a surface making sure that it does not fold or create anywhere. Measure along the inner seam of the trousers from the crotch to the leg cuff.



### IT Inshore Sailing Jacket

The classical Inshore jacket is made of a robust Nylon Oxford and 100% waterproof with all seams seal taped. It features reinforced elbows, two way front flapped zipper, adjustable waist band, pockets, handwarmer pockets, wallet pocket, hood stored under collar, fleece lined collar, inner neoprene hand cuffs, lifejacket attachment loops and retro reflective tapes for high visibility.



	Code	40295	40296	40297	40298	40646
	Code	40305	40306	40307	40308	40647
	Code	40315	40316	40317	40318	40648
	Size	S	M	L	XL	XXL

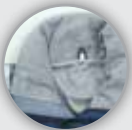

Fleece lined collar



Re-inforced elbow patches



Waist band



Neoprene inner hand cuffs

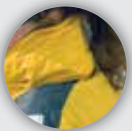

Hood stored in collar



Adjustable waist



Pocket



Re-inforced Seat & Knee Patches



### IT Inshore Sailing Trousers

The Inshore trousers are made of the same robust Nylon Oxford as the Jacket. They are 100% waterproof with all seams sealed. They feature 600D reinforced seat and knee patches, adjustable waist, adjustable shoulder, front zipper, while they cover the body up to the height of the chest.

The trousers are available in fashionable grey and in sizes that correspond to the jackets.



Code	40325	40326	40327	40328	40649
Size	S	M	L	XL	XXL



Workwear Coverall, Cotton 200gsm



100% COTTON  
MERCERIZED & TWICE  
PRE-SHRUNKED

● Code	72637	72638	72639	72640	72641	72642	72643
● Code	72644	72645	72646	72647	72648	72649	72650
○ Code	72651	72652	72653	72654	72655	72656	72657
Size	S	M	L	XL	2XL	3XL	4XL



Oeko-Tex fabric



Velcro

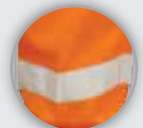

Retroreflective tapes

Raincoat & Rainsuit

LALIZAS Rainsuit with Hood, Yellow



- Ideal for all water related activities
- Suitable also for water related working operations
- Concludes net fabric at the inner chest size of the coat at the top part so as not to 'stuck' onto the clothes or human fabric
- Made of 100% waterproof polyester with PVC backing
- The seams are internally welded with PVC material for extra durability
- It has outer pockets on rainsuit on top part and on raincoat
- The rainsuit trouser has elastic waistband

- Features zippers and buttons on, consisting of a foldable hood in collar and have storm cuffs on rainsuit on top part and on the raincoat
- Designed to be lightweight in order not to stress the user
- Even fish blood and grease stains can be easily removed
- Available in visible yellow colour, in 6 sizes
- Tested according to and found to be in compliance with the European Standards, EN 343 and EN ISO 13688 for protective clothing, offering the highest level of PPE rain protection.

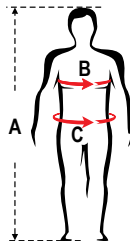

LALIZAS Rainsuit with hood

Code	73683	73684	73685	73686	73687	73688
Side	S	M	L	XL	2XL	3XL
A (cm)	170-172	174-176	178-180	182-184	186-188	190-192
B (cm)	92-96	100-104	108-112	116-120	124-128	132-136
C (cm)	80-84	88-92	96-100	104-108	112-118	120-124

LALIZAS Raincoat with hood

Code	73677	73678	73679	73680	73681	73682
Side	S	M	L	XL	2XL	3XL
A (cm)	170-172	174-176	178-180	182-184	186-188	190-192
B (cm)	92-96	100-104	108-112	116-120	124-128	132-136
C (cm)	80-84	88-92	96-100	104-108	112-118	120-124





### Fishermen's Jackets & Trousers

- Designed to minimize the possibilities for nets to get caught while working
- It has a 0,35mm double PVC coating on the inside & outside of the fabric
- Instead of seam stitching, the different garment parts are "glued" to provide 100% waterproofness
- The jacket features full front flapped zipper and inner hand cuffs
- The pants cover the body up to the height of the chest
- Features elastic adjustable belt straps and buckle closure
- Even fish blood and grease stains can be easily removed

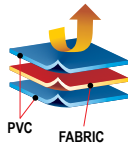

#### Jacket

● Code	40175	40176	40177	40178	40179	72488
● Code	40185	40186	40187	40188	40189	72489
Size	S	M	L	XL	XXL	XXXL

#### Trousers

● Code	40195	40196	40197	40198	40199	72490
● Code	40205	40206	40207	40208	40209	72491
Size	S	M	L	XL	XXL	XXXL



Velcro tape at hood chin



Full storm flap



Inner elastic hand cuff



All seams are sealed



Inside trouser pocket

### Fishing Waders, PVC

The Fishing Chest Waders are available in green colour, with inner chest pocket and heavy-duty adjustable elastic suspenders for a comfortable fit. The boots feature an Antislip sole design for excellent traction on slick. They are made of PVC and are supplied with a service kit (glue, fabric pieces).

They matche with LALIZAS Fishermen's Jackets (40175-40179).



Clothing & Accessories

Code	71052	71053	71054
Size	41	42	43

Code	71055	71056
Size	44	45



**Wetsuit Full Length Neoprene 3:2mm, Black**

Full wetsuits are your winter sport garment for the sea. Your main body is covered with 3mm neoprene thickness, while your legs and arms are covered with 2mm neoprene thickness. Therefore, the neoprene suit keeps your body warm and offers you high degree of flexibility. Flatlocked seams, waterproof back zipper, adjustable neck and aqua stops at legs prevent water leaks and keep you warm. Wind resistance is provided to your chest and back, which are covered by an additional overlay of impermeable fabric. This wetsuit is equipped with special kneecaps and a hidden small pocket (at the back) for your keys.

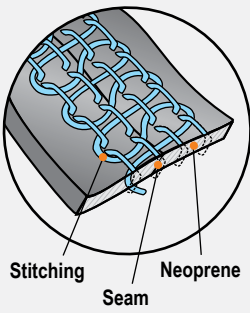
**Flatlock Stitch**

The flatlock stitch is suitable for wetsuits usually worn in warmer weather conditions, made of neoprene with maximum thickness of 3mm.

Two pieces of neoprene are butted against each other edge to edge and the stitching goes back and forth side-to-side, creating a very flat stitch (flatlock). You can very easily identify the flatlock stitch on the suit, by the thread on both sides of a wetsuit. Also, the flatlock stitch does not irritate the user's skin, as it would if the seam ran inside the suit.



Code	72555	70526	70527	70528	70529	70530	72556
Size	XS	S	M	L	XL	XXL	XXXL

**WETSUIT SIZING MEASUREMENTS**

Dimensions are in cm

Size	XS	S	M	L	XL	XXL	XXXL
Height	162-170	167-175	175-181	181-187	184-190	187-193	190-196
Waist	67-73	70-76	74,5-80,5	83-89	87-93	91-97	95-101
Chest	89-89	89-95	94,5-100,5	102,5-108,5	107-113	111-117	115-122
Hips	85-91	88-94	92,5-98,5	101-107	105-111	109-115	113-119

Boots

**Semi Dry Boots, 6mm**

Neoprene boots protect your feet from cold waters. They are made of neoprene 6mm thick, to keep your body warm in cold waters. Blindstitched seams inside and outside the boots, waterproof zipper and a special neoprene cover behind the zipper to prevent water leaks. Boots completely embrace your feet with neoprene flexibility and the rubber reinforced toes and heels, which offer stable foot-holding, additional water resistance and protection from land or boat obstacles. Boots have thick rubber soles for better traction on all surfaces. The black rubber on the bottom of soles does not leave marks on your boat.

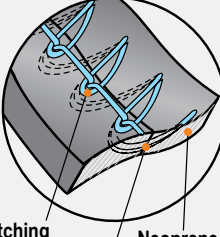
**Blindstitch**

The blindstitch is the perfect solution for the construction of winter wetsuits, since it is a totally waterproof stitch. Two pieces of neoprene are butted against each other and stitched together, with the needle going only half way through the neoprene before going back out. In this way, there is no stitch on the outer part of the wetsuit. The edges of the neoprene are also glued when they are butted together before stitching, for creating an even more waterproof seam. Lastly, the blindstitch does not irritate the skin of the user, as the seam does not run inside the suit.

Code	70561	70562	70563	70564	70565	70566	70567	70568
No	36	37/38	39	40/41	42	43/44	45	46/47





### Long Leg Tie-Top Rubber Sailing Boots

Smartly designed LALIZAS "Long-Leg Tie-Top" Sailing Boots are perfect for sailing. Made of natural rubber with razor cut non-slip soles for better traction. Hard wearing with extra toe and heel reinforcement. The "Tie-Top" boots feature a cushioned leg top making them extremely comfortable to wear. Available in navy blue, with contrasting white trim and in 10 sizes.



Code	40431	40432	40433	40434	40435
No	38	39	40	41	42
Code	40436	40437	40438	40439	40440
No	43	44	45	46	47

### Deck Shoes



### "Skipper" Deck Shoes

Cruise in style with LALIZAS "Skipper" Deck Shoes. Designed to provide comfort and durability, they are ideal for use at all times, while travelling at sea or strolling on land. The "Skipper" shoes are hand-sewn and made of premium Mexican leather with rawhide lacing. Their non-slip rubber outsole has a special design, so as to offer maximum traction and safety on any wet and slippery surface, such as decks and docks. Their classic moccasin design allows a perfect fit to your own foot's bone structure. These versatile shoes are available in three different colour combinations and each in 11 sizes. They are available in brown with white or brown outsole and Navy blue with white outsole.



#### "Skipper" Deck Shoes, Brown Leather with White Sole

Code	40561	40562	40563	40564	40565	40566	40567	40568	40569	40570	40571
No.	36	37	38	39	40	41	42	43	44	45	46

#### "Skipper" Deck Shoes, Brown Leather with Brown Sole

Code	40572	40573	40574	40575	40576	40577	40578	40579	40580	40581	40582
No.	36	37	38	39	40	41	42	43	44	45	46



#### "Skipper" Deck Shoes, Navy Blue Leather with White Sole

Code	40594	40595	40596	40597	40598	40599	40600	40601	40602	40603	40604
No.	36	37	38	39	40	41	42	43	44	45	46

### Sportive Deck Shoes

LALIZAS sportive deck shoes with their updated design, will meet your needs onboard and off the board. Their unique design ensures stability and safety on board, even on wet and slippery surfaces, making them your ideal choice. It features air mesh panels for greater breathability, quick dry footbed and a non-slip TPR outsole that will keep you maneuvering fast on your feet, even on wet deck. It has a modern design and offers comfort and ease of walking.

Code	70917	70918	70919	70920	70921	70922	70923	70924	70925	70926	70927	71020
No	35	36	37	38	39	40	41	42	43	44	45	46



Non-slip TPR outsole for outstanding shock absorption



## Hats & Caps

**LALIZAS**

### Sailing Caps

100% washed out twill cotton caps.



Code	40060	40664
Colour	Blue	Red

### Sailing Cap with Protective Neck Cover

Made of cotton fabric. It features Velcro strap-closure at the back so that you can roll up the neck cover and wear it as a simple cap.



Code	40557
Colour	Blue

### Available only in Greece & Cyprus



### Captain's Cap, Cotton, White

Code	71047	71048
Size	M (57)	L (60)



### Canvas Hat

Code	71049	71050	71051
Size	S (55)	M (57)	L (59)



### Greek Fisherman Cap, Handmade

Code	71043	71044	71045	71046
Colour	Black		Navy Blue	
Size	M (57)	L (60)	M (57)	L (60)

## Gloves

**LALIZAS**

### Gloves 5 & 2 Finger Cut, Amara

The brand new Amara Leather LALIZAS gloves are suitable for every water or land activity. They come in two models, in 2 or 5 Finger Cut, and are made of Amara leather, neoprene and a special extra durable fabric. The special Velcro above the wrist ensures ultimate fit.

Both the 2 and 5 finger cut models are extremely durable and soft, and the extra Amara leather below the fingers and palm makes them the ideal choice for marine use, especially when dealing with ropes and winches.



### Gloves 5 Finger Cut, Amara

Code	71688	71689	71690	71691	71692
Size	S	M	L	XL	XXL



### Gloves 2 Finger Cut, Amara

Code	71693	71694	71695	71696	71697
Size	S	M	L	XL	XXL





### Gloves for Sailing 5 Finger Cut, Kevlar Type

Soft and comfortable 5 finger cut gloves with Kevlar type palm reinforcement for best grip and durability. We've combined Kevlar type and its advantages, with the very best soft Amara leather and elastic spandex in order to create the 'ultimate' sailing glove in grip and fit.

Code	40103	40105	40106	40107	40108	40663
Size	XS	S	M	L	XL	XXL



### Full Finger Gloves Neoprene, 2mm, Black

Full finger neoprene gloves are your essential ally against cold and wind in water sport activities. Your hands are sealed with 2mm neoprene for protection and flexibility in cold waters. Your palm and fingers are covered with smooth Amara leather for excellent grip of ropes, fishing guns, paddles and other sea-sport equipment.

Code	70569	70570	70571	70572	70573	70574	70575
Size	XXS	XS	S	M	L	XL	XXL

### Gloves Sizing Measurements

Dimensions are in cm

#### Gloves 5 Finger Cut, Amara

Size	S	M	L	XL	XXL
Length	18,5	19,05	19,5	20,6	21,1
Palm	21,8	23,1	23,8	24,6	25,9
Wrist	18,8	19,3	20,3	20,8	21,3

#### Gloves for Sailing 5 Finger Cut, Kevlar Type

Size	XS	S	M	L	XL	XXL
Length	15,5	17,5	18	18,5	19	19,5
Palm	9,5	10,5	11	11,5	12	12,5
Wrist	7,5	9	9,5	10	10,5	11

#### Gloves 2 Finger Cut, Amara

Size	S	M	L	XL	XXL
Length	21,1	21,6	22,1	23,1	23,6
Palm	21,8	23,1	23,8	24,6	25,9
Wrist	18,8	19,3	20,3	20,8	21,3

#### Full Finger Gloves Neoprene, 2mm

Size	XXS	XS	S	M	L	XL	XXL
Length	24,1	25	25,5	26	26,5	27,5	28
Palm	8,9	9,5	10	11	11,5	12	12,5
Wrist	7,6	8,5	9	9,5	10	11	11,5

## Dry Bags & Bags



### Dry Bags

The dry bag is an ideal product for river rafters and every "sea-man". The LALIZAS dry bags are remarkably strong and leakproof. Made of incredibly strong PVC. A three-roll watertight closure system keeps everything inside clean and dry. Available in two colours, red and clear. The see-through model helps the user to locate the items he requires. Also available in four sizes.

Code	Dimensions (mm)	Liters	Colour
10001	400 x 250	5	Clear
10002	600 x 300	12	Clear
10003	700 x 350	18	Clear
10004	800 x 500	55	Clear
10011	400 x 250	5	Red
10012	600 x 300	12	Red
10013	700 x 350	18	Red
10014	800 x 500	55	Red



The wide range of Lalizas' dry bags allows you freedom of choice according to your needs



To ensure maximum dryness roll the top of the bag down (closure system) at least three times



Clip the buckle in



When everything is ready, the bag may be carried or stored



## Dry Bags Ténéré

The new heavy-duty dry bag Ténéré is an ideal choice for kayaking, canoeing and rafting lovers but also for every "sea man" as its improved three-roll watertight closure system ensures that all the contents stay clean and dry. This hot air welded dry bag is made of durable PVC Tarpulin 500D, 0.55mm thick, which makes it suitable for great load and heavy-duty activities. Ténéré is wipe-clean, easy to store and have a shoulder strap that makes it handy to carry on shore. Additionally, the 30Lt and 40Lt capacity models have an extra handle welded on the product. "Ténéré" bags are available in sand, red and yellow colour and in 6 different sizes.

Code	Dimensions (mm)	Liters	Colour	With handle
70291	400x200	5	Sand	
70292	550x200	10	Sand	
70293	500x250	15	Sand	
70294	660x250	20	Sand	
70295	600x300	30	Sand	•
70296	740x300	40	Sand	•
70297	400x200	5	Red	
70298	550x200	10	Red	
70299	500x250	15	Red	
70300	660x250	20	Red	
70301	600x300	30	Red	•
70302	740x300	40	Red	•
70303	400x200	5	Yellow	
70304	550x200	10	Yellow	
70305	500x250	15	Yellow	
70306	660x250	20	Yellow	
70307	600x300	30	Yellow	•
70308	740x300	40	Yellow	•



Handle  
(in 30L & 40L)



new

## LALIZAS Dry Bag for Distress Signals/ Pyrotechnics



- Dimensions: Ø16 x 48 cm
- Material: Transparent PVC

\* Distress Signals not included

Code | 74636

## Dry Bags for Handhelds

The ultimate dry bag for the protection of your handheld electronic equipment (GPS, VHF, mobile phone). Made of durable vinyl, it has clear front panel, which allows you to see displays and button logos and access most functions, without removing the bag. Furthermore, each dry bag has a lanyard loop. Depending on the air captured and the weight of the equipment inside, the bags may or may not float. Although Lalizas Dry Bags are made to withstand harsh conditions, it is suggested that you test for waterproofness regularly to detect any pinhole leaks.



Code	Description	Dimensions (cm)	
		A	B
10440	Dry Bag for mobile phone	19	10
10441	Dry Bag for small VHF	35	10
10442	Dry Bag for VHF	40	10
10443	Dry Bag for small GPS	23	9,5
10444	Dry Bag for GPS	30	12,5

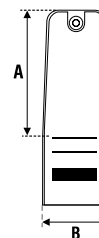

The sizes shown are when the bag is empty.



### Dry Briefcase

LALIZAS Dry Briefcase has been designed especially for the protection of your boat's documents. Made of durable vinyl, it has clear front panel, which allows you to see the contents of the bag. Furthermore each dry bag has a lanyard loop. The Dry Briefcase has the advantage of floating on the water, depending, however, on the air captured and the weight of the contents. It features a 100% waterproof seal with Velcro.

The ultimate protection for your boat's documents.

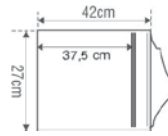

The dimensions shown are when the bag is empty.



Code | 10450

### Under Seat Storage Bag, Ténéré Sit & Store

The under seat storage bag provides you with the extra storage space that is so necessary on any boat. It is made of PVC Tarpulin and has been designed to fit to any seat. It also features a shoulder strap which allows you to carry the bag when you leave the boat. The top of the bag is padded to "soften the ride" on the wooden seat. It is water resistant, while the waterproof zipper keeps the storage area dry. It is available in grey colour.

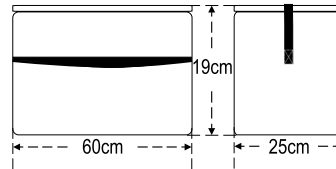

Code | 70895

### Lifejackets Dry Bag

- Simple and easy-to-use Lifejackets Dry Bag
- The most "intelligent" and waterproof storage solution for all the necessary safety equipment of your boat
- Made of durable transparent material, without any unnecessary seams
- It meets the minimum space consumption requirements
- It offers the ability of immediate use in case of an emergency or a boat inspection
- Specially designed for storing foam lifejackets of 100N & 150N
- Can safely store all hand and smoke signals required by regulations, in the available space between the lifejackets' neck grooves



\*Lifejackets not included

Code	Size	Dimensions (cm)	Suitable for LALIZAS Lifejackets		
			70991 (100N)	70993 (150N)	70159 (Solas '74)
71220*	1	93x57x36	4	3	5
71221*	2	93x68x36	6	4	7
71222*	3	93x93x36	9	6	10

Clothing & Accessories

new

### Waterproof Bag



Code | 196107

Dimensions: L660xW400xH480mm

**TR90 Sunglasses**

The TR90 sunglasses line by LALIZAS has been created to satisfy the most demanding needs of yours. The TR 90 material used in the frames of the sunglasses makes them safer against the extreme temperatures and more durable to continuous and harsh use. Additionally, the lenses used are polarized and thus the glare and eyes strain are reduced substantially. The modern design, as well as, the specialized manufacturing, makes the sunglasses ideal for use in sports, but also in other activities which involve prolonged sun exposure.



**Sunglasses, TR90, Polarized  
1.10mm, Black**



Code | 71033

**Sunglasses, TR90, Polarized  
1.10mm, Black**



Code | 71034

**Sunglasses, TR90,  
Polarized 1.10mm, Black**



Code | 71035

**Sunglasses, TR90,  
Polarized 1.10mm, Grey**



Code | 71036

**TR90**

The TR 90 material is a transparent polyamide with good heat resistance and excellent fatigue behaviour. It is lightweight, resistant to stress cracking and stands up well against UV exposure. That is why it is commonly used for the creation of sport and other impact-resistant eyewear frames. Additionally, due to the fact that it contains no plasticizer and resists cosmetic chemicals and perspiration, it offers a very good alternating bending strength and it can enhance the design and performance of sport and safety spectacle frames. It also exhibits low moisture absorption and dimensional stability, while its outstanding weathering stability, makes it particularly suitable for eyewear frames

**UV Protection**

The most important benefit that sunglasses should provide is protection from ultraviolet radiation (UV), which contributes to various eye diseases. Ultraviolet radiation has been linked to cataracts, benign growths on the eyes surface, cancer of the eyelid and of skin around the eyes and photokeratitis (snow blindness), a temporary but painful sunburn of the eye's surface. UV protection is the most important feature to take into consideration while looking for sunglasses. The FDA, the government agency that oversees sunglass manufacture and sales in the U.S., recommends that customers should look for sunglasses with lenses that block 99-100% of UVA and UVB radiation (100% is best) and therefore provide UV 400 or 100% UV protection.

**“POLARIZED” Lens**

The bright sunlight is reflected on many surfaces that surround us, such as water, snow, pavement, dust, buildings, ice, sand, wet road surfaces and windshields and resulting to an annoying glare for the eyes that reduce contrast and visual sharpness. The eyes cannot eliminate reflective glare independently. In order for the eyes to focus, they allow the access of even the slightest light and in this way various types of light “penetrate” the eyes, including the bright sunlight. The result is tired eyes, headaches, poor vision and sun damage to the eyes. Even if the eyes can’t “apprehend” the UV rays, they should be of concern, because of their long term damaging effects on the eyes. Polarized lenses are designed to substantially reduce or even eliminate reflective glare by selectively absorbing the light waves travelling in all directions except the vertical plane. At the same time UV rays are blocked. Bear in mind that the only thing that regular lens without polarizing film does, is just to darken the eyesight without protecting the eyes. In other words, polarized lenses are ideal for anybody who wants to avoid glare and to improve their vision in the sunlight.

Available only in Greece & Cyprus



**Croakies Arc Combo XL/XXL,  
Adjustable, 2 Pairs of Ends**

Code | 63435



**Croakies  
Solids Mix**

Code | 63437



# Cleaning & Maintenance



Whether you own a small, medium or large boat, you need to take care its regular and proper maintenance in order to sustain its longevity and high value.

Keep your boat clean and leave a layer of protection with IOSSO cleaning products that you will find at MARINA Stores. Remove dirt, rust, stains, bad smells, and clutter on surfaces and keep your boat in perfect condition till your next voyage.

<b>Thinners</b> _____	<b>390</b>	<b>Multi-Tools &amp; Cutters</b> _____	<b>393-394</b>
<b>Varnish</b> _____	<b>390-391</b>	<b>Pocket Knives</b> _____	<b>394</b>
<b>Teak Care</b> _____	<b>391</b>	<b>Polyurethanes</b> _____	<b>394</b>
<b>Nonskid Products</b> _____	<b>391</b>	<b>Glues &amp; Repair Kits</b> _____	<b>394-395</b>
<b>General Use Tapes</b> _____	<b>391-392</b>	<b>Polishing &amp; Waxing</b> _____	<b>395</b>
<b>Teak Drain Plugs</b> _____	<b>392</b>	<b>Cleaning Products</b> _____	<b>395-397</b>
<b>Boat Lettering &amp; Signs</b> _____	<b>392-393</b>	<b>Boat Brushes &amp; Handles</b> _____	<b>398-399</b>
<b>Tool Kits</b> _____	<b>393</b>	<b>Buckets</b> _____	<b>399</b>

## Thinners



### EPIFANES Brush thinner for One-component Paint & Varnish

EPIFANES thinner for paint and varnish is a pure white spirit for thinning one-part paints and varnishes applied by brush. Just add some product in increments, always in accordance with the product instructions per case.

<b>Code</b>	99221	99222	99223
<b>Package</b>	500ml	1lt	5lt

## Varnish

### EPIFANES Poly-urethane Clear Gloss, 2 Components, with UV Filter



A high gloss, two-component, polyester saturated, aliphatic urethane finish with excellent outdoor durability. Contains UV filter. To be used on intact existing poly-urethane varnish systems, as a complete varnish system on bare dimensionally stable wood (i.e. marine plywood), as a build-up coat prior to a one-component varnish system, as a protective coat on epoxy resins or as an intermediate coat on epoxy resins when a one-component finish is desired. Suitable for fresh and salt water, for interior and exterior use. Mixing ratio is 2 parts of component A to one part of component B by weight. Each can is partially full. Pour the reactor (B) into the can of base (A) and stir thoroughly. Allow to activate for 20-30 minutes before use. Police after mixing 3-4 hours at 20° C. (70 o F). Temperature should be between 15° C and 27° C (60o - 80o F) during application. For brush/roller or spray application use the appropriate thinner. **Recoatable:** After 24 hours at 18oC (6oF) Coverage: 750gr is sufficient for 9sq. meters (100sq.feet)

<b>Code</b>	98782
<b>Package</b>	750gr

### EPIFANES Rapidclear



Superior quality, semi-gloss wood finish based on modified alkyd/urethane resins and UV filters. It is a quick and easy alternative to conventional varnish, since it can provide excellent protection in all climates. It is ideal for long term protection and enhancement of all interior and exterior marine and household woods above the waterline. EPIFANES Rapidclear provides an enhancing UV protecting film. It bonds extremely well to teak and other oily woods, preventing discolouration and emphasises the natural grain of the wood. It can be used for renewing weathered areas, prior to a varnish or as a full system for those requiring a quick an easy semi-gloss finish with excellent breathing properties, flexibility, maximum durability, UV protection and longevity. Apply by brush, foam brush, roller or spray 3 to 4 coats. Three to four coats are sufficient to most conditions. Sanding between coats is not required. If top coated with varnish, sand with 220 grit dry abrasive paper. Easy touch up and maintenance.

**Thinner:** Brush application - Do not thin Spray application- Use the appropriate thinner

**Recoatable:** After 5-6 hours at 18°C (65°F)

**Coverage:** 750ml is sufficient for 10 sq.meters

<b>Code</b>	98787
<b>Package</b>	750ml

### EPIFANES Woodfinish Gloss, High Gloss, with UV Filter



A clear, high gloss varnish-like finish with excellent adhesion to new teak and other oily woods. To be used on teakwood, iroko and as an alternative for continuous maintenance of wood oil systems, for interior and exterior work above the waterline in both fresh and salt water environments. When applied on non-oily wood that does not need to "breathe", a minimum 8-10 coats are required. Not suitable for bankirai. For brush or spray application use the appropriate thinner.

**Recoatable:** After 24 hours at 18oC (65oF). No sanding required if recoated within 72hours

**Coverage:** One liter is sufficient for 12sq.meters (130sq.feet)

<b>Code</b>	98780
<b>Package</b>	1lt

### EPIFANES Woodfinish, Matte



A clear satin finish for use over Epifanes Woodfinish Gloss (one component). It provides a beautiful, satin sheen for interior use. For brush or spray application use the appropriate thinner.

**Recoatable:** After 12 hours at 18°C (65°F)

**Coverage:** One liter is sufficient for 12sq.meters (130sq.feet)

<b>Code</b>	98781
<b>Package</b>	1lt

### EPIFANES Clear Varnish, High Gloss



A clear, high gloss, traditional one-component varnish, based on tung oil, phenol and alkyd resin with excellent outdoor durability, containing an ultra violet filter protecting the wood against discolouration. For use on bare wood, inside and outside above the waterline. For brush or spray application use the appropriate thinner.

**Recoatable:** After 24 hours at 18°C (65°F)

**Coverage:** One liter is sufficient for 14sq.meters (150sq.feet)

<b>Code</b>	98772	98773	98774	98775
<b>Package</b>	250ml	500ml	1lt	5lt





**EPIFANES Rubbed Effect Varnish, Poly-urethane Resin**

A quick drying, clear, one-component, interior satin finish, based on a polyurethane/alkyd resin. It gives superior protection against alcohol and other aggressive household chemicals. Apply as a finish coat over several build-up coats of EPIFANES Clear Gloss Varnish. For brush or spray application use the appropriate thinner.

**Recoatable:** After 12 hours at 18°C (65°F) **Coverage:** One liter is sufficient for 13sq.meters (140sq.feet).

Code	98776	98777
Package	500ml	1lt



Teak Care

**EPIFANES Teak Oil Sealer**

An impregnating oil based on linseed oil and alkyd resin. It protects teakwood from discolouration by weather or pollutants. It is ideal for the maintenance of teak decks. Film build-up must be avoided. Apply with a wide brush or lint free cloth. Use the appropriate thinner.

**Recoatable:** Wet-on-wet  
**Coverage:** 8-10sq.meters (85-100sq.feet)

Code	98786
Package	1lt



**TEAK WONDER Teak Dressing Sealer (Silicone Sealer)**

It keeps the splendid golden appearance without having to wash the teak every day with fresh water. By applying this silicon based product, you seal the pores of the wood, preventing the penetration of the dust and dirt that darken it, and also protecting the natural teak oils against the ultraviolet rays that oxidise and discolour them. The dressing also prevents liquids such as diesel, oil, fish blood, and paints from penetrating the wood, making subsequent cleaning easier. They don't smell, don't become shiny or slippery, don't stick, dry rapidly and do not make or build up the surface.

Code	98863	98864
Package	1lt	4lt



**TEAK WONDER Teak Cleaner & Brightener**

By applying the two products contained in each bottle one after the other, you wash away the grey colour that has accumulated in the wood, rediscovering the splendid golden of the teak. All in a few minutes and without removing millimeters of precious wood from the deck, as occurs during sanding. Neither of these two liquids is aggressive or caustic and therefore does not damage rubber, paint or stainless steel fittings.

Code	Description
98865	Combo Pack Cleaner & Brightener, 2x1lt
98866	Teak Cleaner, 4lt
98867	Teak Brightener, 4lt



98865



98866



98867

Nonskid Products



**Non-slip Tape, with Elasticity**

Non-slip tape for outdoor and indoor use. High quality adhesive and strong durability, available in black or white color. Great resistance to moisture and water. Ideal for deck, stairs, bathrooms, corridors etc. Ideal for boating, home, work places, warehouses, etc.

Code	Dimensions	Colour
11848	25mm x 5m	Black
11849	25mm x 5m	Grey



General Use Cases



**Masking Tape, White**

It is a general-purpose tape, suitable for holding, sealing, as well as surface protecting. It has been designed for indoor use but also for extended outdoor use, since it can withstand up to 80°C temperature. It is supplied in white colour and different sizes.



Code	Dimensions
11851	20mm x 50m
11852	25mm x 20m
11853	50mm x 50m

**Marine Duct Tape**

Multi-purpose, waterproof cloth duct tape, with a strong hold due to fabric reinforcement, suitable for repairs and insulation. It offers excellent durability and strong welding power. This Duct tape can be used in various indoor or outdoor jobs and repairs. Very good adhesion to all types of surfaces. Available in different colours and two sizes.



Code	Dimensions	Colour
11545	50mm x 5m	Black
11546	50mm x 5m	White
11547	50mm x 5m	Red
11548	50mm x 5m	Blue
11549	50mm x 5m	Silver
11550	50mm x 50m	Black



## General Use Tapes



### Mounting Tape, White



Nailing on the boat is over with the double-sided adhesive tape. It is suitable for mounting pictures or any other decoration on most types of dry and smooth surfaces, you don't need nails when decorating your boat.

Code	Dimensions
11850	2mm x 18mm x 1.6m

### Instructions of Use

Use 10cm (4") of tape for every 227gr of the item to be mounted. The tape is suitable for objects with maximum weight up to 900gr.

1. Cut the tape at the necessary length. Do not remove the protective liner.
2. Press the tape on the back of the object to be mounted. Press firmly on the liner for a better outcome.
3. Remove the liner and press firmly the object on the wall.



**Note:** If you wish to remove the mounted object, insert a knife behind the mounted object and cut the tape between the two surfaces. Don't pull the object, in order to avoid damaging the surface or the object.

### Vinyl Foam Thermal & Sound Insulating Tape, Black



The thermal & sound insulating tape is suitable for the pipeline freezing resistance, insulation and decoration. Generally, it is used whenever a specific area or place needs to be insulated in order to be protected by the variations of temperature or even to protect the people on board by undesirable sounds. It can also be used between the hull and the sole boards, so as to minimize the squeaking noises. It is available in 2 different sizes.



Code	Dimensions
11854	50mm x 5m
11855	25mm x 5m

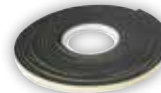

### Marine Neoprene Tape Hatchseal, Black

Self-adhesive neoprene tape with thermal & insulation properties. It also prevents sound, dust and insects. Easily fitted into doors, lazarettes, spotlights, and wherever you wish to use it. Useful accessory that eliminates heat loss in the winter and stops cool air currents from escaping in the summer. Available in two dimensions.

Code	Dimensions
11551	3m x 19mm x 3mm
11552	3m x 19mm x 6mm

## Teak Drain Plugs

### Wood Drain Plug

Code | 71965

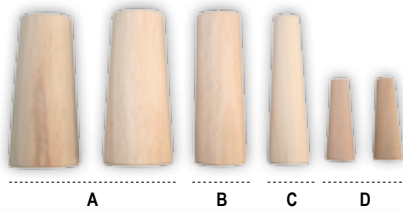

	Number of pieces	Max Ø (mm)	Small Ø (mm)	Length
A	2	51	38	110
B	1	38	33	110
C	1	30	19	110
D	2	22	13	62

## Boat Lettering & Signs



### Letter Case

This case has been designed for the convenient and effective display of the letters, used to mark the boats. It is made of durable vinyl. It is available in grey colour with 36 clear front panels, which allows the customers to see the letters easily, and choose the ones needed. On the top there is a clear pocket (10x45cm) where retailers can place the logo of their shop. No letters are supplied with the letter case.

Code | 10451

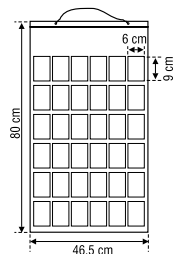

### Numbers & Letters, Black, 7cm

Code	97717	97718	97719	97720	97721	97722	97723	97724	97725	97726	97727	97728	97729	97730	97731	97732	97733	97734	97735	97736	97737
Letter	A	B	C	D	E	F	G	H	I	J	K	L	M	N	O	P	Q	R	S	T	U
Code	97738	97739	97740	97741	97742	97743	97744	97745	97746	97747	97748	97749	97750	97751	97752	97753	97754	97755	97756	97757	
Letter/ Number	V/A	W	X	Y	Z	Γ	Δ	Θ	Ξ	Π	Σ	Φ	Ψ	Ω	0	1	2	3	4	5	
Code	97758	97759	97760	97761	Code	97762						97763									
Letter/ Number	6	7	8	9	Description	Kit of greek - english letters (5) & numbers (5), black						Kit of english letters (5) & numbers (5), black									





Silicone Stickers Ø80mm

No Paper in the Toilet



Code | 95758

No Shoes



Code | 95759

No Bras



Code | 95760

No Swimsuits



Code | 95761

PVC Stickers Ø135mm



No Shoes

Code | 10150



No Smoking

Code | 10160



No Swimsuits

Code | 10170



No Harassing the Captain

Code | 10180



No Bras

Code | 10190

Tool Kits

new



Marine Tool Kit Professional

The Professional Marine Tool Kit (45 pcs) is suitable for dealing with most common repairs on a boat. Equipped with all the necessary tools, such as screwdrivers, pliers, spanners and many others, it is definitely useful for work on the deck, on the engine, or on electrical and electronic appliances. All tools are made of durable chrome vanadium material; they are non-corrosive and designed for long-term use.



Code	11474
Description	Basic
Tools	28*pcs



The Professional Marine Tool Kit includes:

Tool	Pieces	Tool	Pieces
Hex key: 2.5-3-4-5-6-8-10mm, CRV	7	6" Long nose plier, CRV	1
Torx key: T9-T10-T15-T20-T25-T27-T30-T40, CRV	8	8" Diagonal plier, CRV	1
Screwdriver: SL5*75;SL6*100;PH1*75;PH2*100, CRV	4	8" Lock plier, CRV	1
Double open wrench: 6-7, 8-9, 10-11, 12-13, 14-15, 16-17, 18-19, 22-24, CRV	8	10" Adjustable wrench, CRV	1
300g Machinist hammer	1	1/2" Socket set in plastic holder: 1/2" Socket, 10-11-12-13-14-15-17-19-22-24mm; 1/2" Ratchet handle; 1/2" Extension bar 5", CRV	12
8" Combination plier, CRV	1		

Multi-Tools & Cutters

Bolt Cutter, 90cm

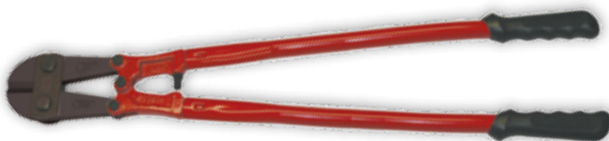

Code | 72199

Cable Cutter, 60cm



Code | 73602



## Multi-Tools & Cutters



**Marine Multi-Function Tool, Red**

Code | 10200

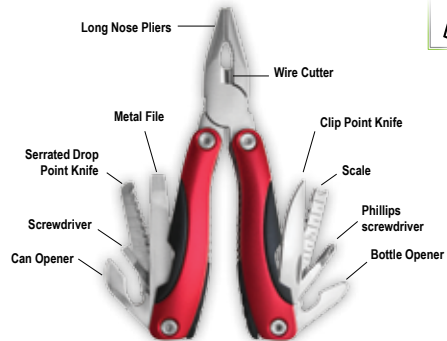

## Pocket Knives

**SkipperMate Knife, INOX, L:11cm**



Code | 11476

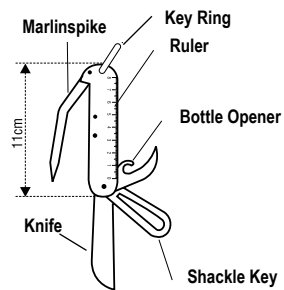

**SkipperMate Knife, INOX, L:9,5cm**



Code | 11477

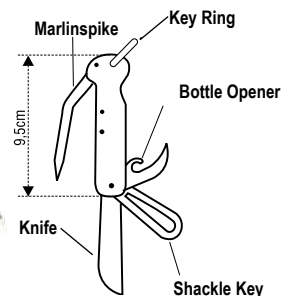

## Polyurethanes



**Sika Polyurethane, 1 Component, 300ml, for Wooden Surfaces, Sikaflex 290Dc, Black**

Code | 63224



**Sika Polyurethane, 1 Material, 300ml, for Collusion-General Use, Sikaflex 291, Black**

Code	63227	63228
Colour	Black	White



**Sika Polyurethane, 1 Material, 70ml, for general use, Sikaflex 291i, Black**

Code	63225	63226
Colour	Black	White

## Glues & Repair Kits

new



Code | 74705



**Repair Kit for Inflatable Boats**

- It includes:**
- PVC Fabric, 2pcs: 150x200mm grey & 150x200mm white
  - Neoprene Fabric, 1pc: 150x200mm black
  - Glue tube 20gr
  - Key for valves





**Repair Kit for Neoprene/Rubber Fabrics**



Code | 72437

- Package Includes:**
- Cleaner - 30ml
  - Hardener/Cross linker - 15ml
  - Primer G.O. - 30ml
  - Glue (PO 40) - 100ml
  - Fabric (neoprene polyester 10x30cm)
  - Brush

- Application for**
- Life rafts
  - Tender boats
  - Fenders
  - Other neoprene & rubber products

**Repair Kit for TPU/PVC/EVA Fabrics**



Code | 72436

- Package Includes:**
- Cleaner - 30ml
  - Hardener/Cross linker - 15ml
  - Glue (PO 40) - 100ml
  - Fabric (Nylon TPU 10x30cm & PVC 10x30cm)
  - Brush

- Application for**
- Life rafts
  - Tender boats
  - Inflatable Fenders
  - Other TPU, PVC & EVA products

Polishing & Waxing

Available only in certain countries



**IOSSO Gel Coat Restorer Quick Gloss K1**

Removes water spots, rust and strong dirt from hard plastic/ polyester and gel coat surfaces. Restores shine and smoothness to the applied surface. Use by hand or with a buffing wheel. Also suitable for painted surfaces and transparent plastics (plexiglass, PVC, etc.).

Code	71116
Package	500 ml



**IOSSO Fiberglass & Metal Polishing Cream**

This easy-to-use polishing cleaner removes oxidation, tarnish, surface rust, and leaves a brilliant shiny protective coating instead. Recommended for use on all metals, plexiglas, hard plastics and painted surfaces. Can be applied in gel coat as well. It restores the colour to the frosted fiberglass surfaces and protects the applied area for months. After application no wax is required. You can use it on plexiglass and painted surfaces, but also to remove dulls, surface dust and oxidation from metals such as chromium, aluminium, magnesium, stainless steel, bronze and copper.

Code	71115
Package	250 ml



**IOSSO Clear Plastic Restorer Glitter**

Fiberglass & Plastic Cleaner/Reconditioner. Cleans plexiglas and hard plastic/ polyester surfaces and eliminates thin scratches. Applied only with a buffing wheel. Also suitable for glass and transparent surfaces.

Code	71117
Package	250 ml



**IOSSO Multi Use Polishing Cream, 50 ml**

Professional non-abrasive polishing product; cleans, protects and polishes the surfaces. Gives again colour to stained fibrous glass surfaces, preserving them for a long time. Removes all types of oxidation, tar and surface rust dirt. Ideal for fibrous glass (gel coat), plexiglass, epoxy painted, metallic (stainless steel, aluminium, copper, brass), chromium plated and magnesium alloys surfaces. It does not request any further polishing actions. For professional use only.

Code | 71728

Cleaning Products

Available only in certain countries



**BARDHAL Diesel Fuel Injector Cleaner**

A professional cleaner for the maintenance of diesel fuel injectors. It keeps the efficiency of the injection system, reduces fuel consumption and the maintenance costs.

- Cleaning and protection of the entire supply system (sprayers, pumps, valves, & chamber)
- Avoids instability at minimum speeds
- Prevents disruption of sprayers & pumps
- Refers to the efficiency of sprayers, ensuring optimum spraying of oil reduces fouling
- Reduces pollution & noise

Code	71139
Package	300 ml



**IOSSO Bilge Cleaner Custom**

A concentrated and bio-degradable cleaner for bilges, engine rooms, garages, and similar use. Dissolves oils, grease, gasoline, and similar remains. Can be used as it is, or slightly-diluted with water.

Code	71121	71122
Package	1lt	4lt



**IOSSO Sea Weeds Remover Decap-Out**

Waterline & hulls sea-weeds remover. Antivegetative descaler for non-metal hulls, keels & tubes. Removes quickly any sort of limes, lime stones, barnacles, sea-weeds and dirt. Suitable also for bathrooms, toilets, tiles and ceramic surfaces. Unsuitable for metal appliances.

Code	71123
Package	1lt



Available only in certain countries



### IOSSO Foamy Metal Cleaner

Universal cleaner, suitable for a wide range of metals, such as stainless steel, copper, brass, silver, gold. Removes superficial oxidations (rust) from hard surfaces and keeps metal bright & shiny.

Code	71126
Package	750 ml



### IOSSO Powerful Cleaner for Inflatable Boats & General Use 123 Via

A powerful cleaner for inflatable boats and general marine use. Removes the remains of petrochemicals, sunscreen, creams, ink, bird droppings and restores the original shine of the buoy. Apply without adding water.

Code	71118
Package	750 ml



### IOSSO Concentrated Powerful Detergent Magic Cleaner

A concentrated & multi-use cleaner for all surfaces, such as wood, plastic, polyester, and even sails. An Eco-friendly biological product, without chlorine that can be diluted with sea water as well.

Code	71124	71125
Package	1lt	4lt



### IOSSO Protective Spray Wax for Inflatable Boats Raft Wonder, 750ml

Code	63763
------	-------



Available only in certain countries

### Descaling condenser 1lit CLIN AZUR



Package	1 lt
---------	------

### Black water treatment CLIN AZUR



#### Functions:

- Stops bad smells.
- Accelerate the organic wastes biodegradation.

#### Features:

- Effervescent tablets highly concentrated with enzymes.
- Non toxic and non caustic.

Package	24 tabs
---------	---------

### Grey waters tanks treatment CLIN AZUR



#### Functions:

- Stops bad smells.
- Degrade and liquefies oils, organic and vegetal greases.

#### Features:

- Active formulation highly concentrated with enzymes.
- Non toxic and non caustic.

Package	1 lt
---------	------

### Oxalic acid CLIN AZUR



#### Functions:

- Cleans, degreases and bleaches the teak.
- Can be used as a multi-purpose cleaner and deoxidizer.

#### Features:

- Oxalic acid cristals

Package	1 lt
---------	------

### Gel-coat restorer 204 CLIN AZUR



#### Functions:

- Removes stains, light scratches, restores original colour and shine.
- For fiberglass, gelcoat, stainless steel and painted surfaces.

#### Features:

- Coarse rubbing compound.
- Silicon and PTFE free

Package	1 kg   250gr
---------	--------------

### Concentrated hull & deck cleaner CLIN AZUR



#### Functions:

- Cleans.
- Degrease.
- Renew.

#### Features:

- For painted surfaces, hulls, superstructures, ropes, etc.
- Concentrated formulation very effective.

Package	1 lt   5 lt
---------	-------------

### Biodegradable concentrate shampoo CLIN AZUR



#### Functions:

- Cleans.
- Protects.
- Brings a glossy finish with no stains.
- Leaves a water repellent film.

#### Features:

- For gelcoat, painted surfaces and varnished.
- Green apple scent.

Package	1 lt   5 lt
---------	-------------

### Fender cleaner and restorer CLIN AZUR



#### Functions:

- Cleans and removes salt, dirt and black stains.

#### Features:

- Based on vegetal solvents.
- Excellent results without altering the rubber.

Package	1 lit
---------	-------

### Sails & canvas cleaner CLIN AZUR



#### Functions:

- Cleans heavy fabric types like sails, awnings, ...

#### Features:

- Concentrated formulation.
- Low foaming and very effective.

Package	1 lit
---------	-------

### Stainless steel polish paste 100ml CLIN AZUR



#### Functions:

- Shines and protects chrome, stainless steel and copper.

- Deoxidizes.
- Erase surface scratches.



### 220 Chrome & stainless steel polish, 250ml

#### Features:

- Acts like a liquid rubber.





Available only in certain countries

**Teak Cleaner CLIN AZUR**



- Functions:**
- Deep cleans teak and exotic woods.
  - Removes the tasks and degreased.
- Features:**
- Alkaline detergent.
  - Safe for fibers and joints.
  - Prepares teak in step 2 (Clin'Azur 201).

Package | 1 lt | 5 lt

**Teak Brightener CLIN AZUR**



- Functions:**
- Renovates and brightens teak.
  - Brings a radiant sandy color.
- Features:**
- Acide solution.
  - Use after Clinazur 200 Teak cleaner.

Package | 1 lt | 5 lt

**Rust streaks remover CLIN AZUR**



- Functions:**
- Deoxidized and removes rust stains.
  - Removes yellow stain.
  - Do not damage the gelcoat.
- Features:**
- Work on plastics, gelcoat, painted surfaces and metal

Package | 1 lt

**Professional multi-purpose cleaner, CLIN AZUR**



- Functions:**
- Cleans.
  - Degrease.
  - Perfume.
  - Multi-purpose.
- Features:**
- Work for engines, bilges, floors, rims, coachworks, plastic or painted surfaces, enamel, stainless steel, etc.
  - Leave a pleasant sea scent.
  - Ready to use.

Package | 700 ml

**Water proofing for fabrics 500ml CLIN AZUR**



- Functions:**
- Protects and treats fabrics.
  - Treats the fibre's heart.
  - Available for fabrics, clothes etc.
- Features:**
- Long time action.
  - Ready to use.

Package | 500 ml

**Leather nutrient cream CLIN AZUR**



- Functions:**
- Cleans, nourishes and protects leathers and vinyls.
  - Prevents drying and premature aging.
- Features:**
- Stabilized and neutral nutrient cream.
  - Pleasant scent.
  - Works on all kinds of leather even the soft ones.

Package | 500 ml

**Black streaks remover 1lit. CLIN AZUR**



- Functions:**
- Cleans.
  - Degrease.
  - Perfume.
  - Multi-purpose.
- Features:**
- Work for engines, bilges, floors, rims, coachworks, plastic or painted surfaces, enamel, stainless steel, etc.
  - Leave a pleasant sea scent.

Package | 1 lit

**Non skid deck cleaner CLIN AZUR**



- Functions:**
- Cleans and removes salt, dirt and crime.
  - For all non skid deck, covers and vinyl.
- Features:**
- Concentrated formulation.

Package | 1 lt | 5 lt

**Polish with reflon, 500ml, CLIN AZUR**



- Functions:**
- High shine finish.
  - Long Lasting Protection.

Package | 500 ml

**Inflatable boats cleaner CLIN AZUR**



- Functions:**
- Cleans and removes salt, dirt, grime and black stains.
- Features:**
- Availabe for all kind of tenders.

Package | 1 lt | 5 lt

**240 Sredstvo za čišćenje aluminija 1lit**



- Functions:**
- Restores and deoxidizes tarnished anodized aluminium.
  - Instant action without efforts.
- Features:**
- For anodized aluminium only.

Package | 1 lt

**Rust converter 250ml CLIN AZUR**



- Functions:**
- Neutralizes rust.
  - Converts the rust in a protective barrier on all ferrous metals.
  - Ideal as a primer before painting.

Package | 250 ml | 1 lit

**Bio. treatment chemical toilets, CLIN AZUR**



- Functions:**
- Accelerate the biodegradation of organic wastes.
  - Removes bad smells.

- Features:**
- Bioenzymatic action.
  - Non toxic and non caustic.
  - Leave a sweet cheery scent.

Package | 1 lit





## Boat Cleaning Set

The set consists of one wash brush (50904), one scrub brush (50905), one hook and one telescopic handle. The boat brushes are used for gentle or hard cleaning respectively. They are made of polypropylene body and PVC bristles to resist better against the salt and the sun. The nylon hook is light, with small length and large angle for easier and better hooking. The brushes and hooks by are made of thread, in order to be fitted to the handle. The telescopic handle is 110cm long and can extend up to 200cm, so that you can adjust it accordingly. It is made of anodised aluminium for more durability and longevity. These cleaning products have been designed according to your needs, for your own convenience.

Code | 50906



## Boat Wash Brush Flow Thru, Medium Bristle, Yellow

Made of dense medium bristles that retain water and create rich foam, making it ideal for cleaning surfaces with no persistent dirt. It incorporates a screw thread to attach any of the plain or telescopic handles (57340-2). Even more, its improved design with flow-thru system allows you to attach the relevant handle (57344) and have a constant flow of water right at the point you are cleaning. Unlike traditional wooden brushes, this one is made of polypropylene body - 20,3cm in length - and PVC bristles 6,5cm long, offering more durability and greater resistance to sun and salt water. Finally, its white silicone bumper will protect your boat surfaces from any damage during cleaning.

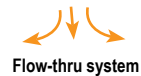

Code | 50904

## Boat Wash Brush Flow Thru, Bi-Level, Medium Bristle, Yellow

Ideal to clean all parts of the boat. It features a two level surface brush. One of the surfaces allows you to hold it like all brooms and clean horizontal surfaces, like the deck. The second surface allows you to hold the handle parallel to the surface you are cleaning, which is very convenient when cleaning surfaces like the freeboard. Its dense medium bristles retain water and create rich foam, making it ideal for cleaning surfaces with no persistent dirt. It incorporates a screw thread to attach any of the plain or telescopic handles (57340-2). Even more, its improved design with flow thru system allows you to attach the relevant handle (57344) and have a constant flow of water right at the point you are cleaning. It is made of polypropylene body - 25,4cm in length - and PVC bristles 6,5cm long, offering more durability and greater resistance to sun and salt water. Finally, its white silicone bumper will protect your boat surfaces from any damage during cleaning.



Flow-thru system

Code | 57345

## Boat Scrub Brush Flow Thru, Hard Bristle, White

Ideal for scrubbing surfaces where stubborn and persistent dirt exists, since it is made of hard bristles for fast and effective cleaning. As with the medium brush, the scrub brush also incorporates a screw thread to attach any of the plain or telescopic handles (57340-2). Additionally, it features flow-thru system, which allows you to attach the relevant handle (57344) and have a constant flow of water through them right at the point you are cleaning. It is highly resistant to the marine environment, since it is made of polypropylene body 20,3 cm long and 5cm PVC bristles. Finally, it features white silicone bumper, which will protect your boat surfaces from any damage during cleaning.

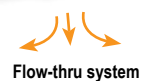

Flow-thru system

Code | 50905





## Boat Brush Flow Thru, 4 sides, yellow

The 4-side boat brush ideal for cleaning all surfaces on the boat. Unlike wooden brooms, this has greater resistance to corrosion by the sun, salt and detergents due to its construction material. With flow-thru system that allows water to pass through the boat brush.

Code | 70689



## Boat Hooks

Alternatively, the boat hook head (57343) is also available. It is lighter, reinforced for extra strength, with a wider opening, which allows you to capture objects more easily. This hook head can be used with the plain (57340) or telescopic tubes (57341 - 57342), which are sold separately. All LALIZAS boat hooks are manufactured following the highest standards. The hooks are made of Nylon and the poles of high-quality anodised aluminium for longer life.

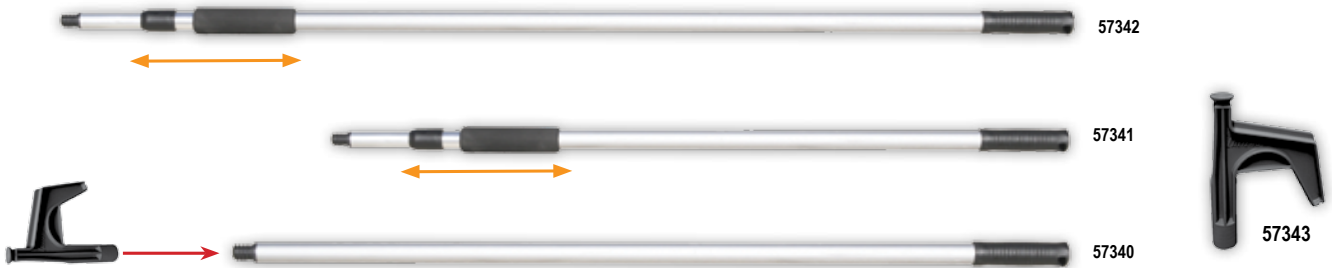

Code	Description	Diameter (cm)	Length (cm)	
			Min	Max
57340	Aluminum Tube for hook/broom	2,5	130	
57341	Aluminum Tube Telescopic for hook/broom	2,2 - 2,5	110	175
57342		2,2 - 2,5	170	305
57343	Hook with Thread - Black	2,2	-	

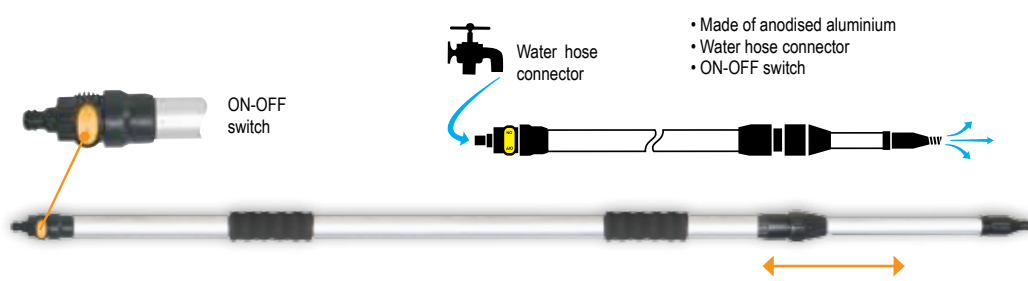

## Telescopic Handle Flow Thru for Boat Brush

Code	57344
Length (cm)	127 - 220
Diameter (cm)	2,5 - 3,2

## Buckets



### Marine Bucket, Black

Code	72059	90598
Capacity (lt)	7,5	10
Material	rubber	plastic

### Fabric Bucket



Code	99203
Capacity (lt)	8
Diameter (cm)	24
Height (cm)	22



**A**

Adjuster	
Cover	230
Hatch	195
Stay	244
<b>Anchor</b>	
Bow-roller	83
Roller	83,86
Ropes	84
<b>Anchors</b>	
Bruce	81
CQR	81
Danforth	81
Delta	81
Folding	81
Grapple	81
Hall Type C	81
Rocna	82
Sea	34, 35
Vulcan	82
<b>Anodes</b>	
Conical	148
Honda	151
Hull	149
Inboard	149
Max prope	148
Mer cruiser	150
Mercury	150
OMC/Johnson	149,151
Propeller	148
Suzuki	151
Volvo	150
Yamaha	151
Yanmar	150
<b>Antenna</b>	
Base	258,259
Cable	258
Connector	258
Splitter	256
<b>Antennas</b>	
AIS	258
Radio	256
Internet	257
Television	256
VHF	256,257
<b>Ashtray</b>	<b>357</b>

**B**

Lifejacket Storage	18,387
Under seat	387
<b>Bailers</b>	<b>52,156,168</b>
<b>Barbecue</b>	
Accessories	350
Gas	349
Grill	350
<b>Barometer</b>	<b>356-357</b>
<b>Barrel Bolt</b>	<b>214-215</b>
<b>Base</b>	
Antenna	258,259
Hook type	239
Horseshoe lifebuoy	30
Life jacket light	23
Life raft	52
Lifebuoy light	24, 30
Outboard engine	134-135
Quick release	226-227
Rail support	204,212,213,355
Rod	373-374
Seat	219-220

Switch	340
Table	221
Telescopic	227
Top slide	225-226
Trash bag	203,355
<b>Bathyscope</b>	<b>373</b>
<b>Battery</b>	
Box	344-345
Case	201,345
Cover	344
Holder Tray	344-345
Lead terminal	344
Switch	345
<b>Belts</b>	
Lifejacket	15
Safety	14
<b>Bimini</b>	<b>222-224</b>
<b>Bimini Accessories</b>	<b>226</b>
<b>Binoculars</b>	<b>261-262</b>
<b>Black Ball</b>	<b>59</b>
<b>Black Cone</b>	<b>59</b>
<b>Blade for Paddles</b>	<b>123-124</b>
<b>Blocks</b>	<b>240-244</b>
<b>Boat Mover</b>	<b>120</b>
<b>Bolt Cutter</b>	<b>393</b>
<b>Books</b>	<b>268-269</b>
<b>Boots</b>	
Long-Leg	383
Neoprene	382
<b>Bosun's Chair</b>	<b>246</b>
<b>Bow Stop</b>	<b>171</b>
<b>Breathing Apparatus</b>	<b>53</b>
<b>Brushes</b>	<b>398-399</b>
<b>Bucket</b>	<b>80,399</b>
<b>Buckles</b>	<b>247</b>
<b>Bulbs</b>	<b>322-330,346-347</b>
<b>Buoy</b>	
Diving	105,371
For mussel farming	103
Marking	101-105,371
Mooring	101,103,376
<b>Buoyancy Aids</b>	<b>20-23</b>

**C**

Cable	
Control	140
Grommet	138-139
Outlet	334
Terminal	334,335
<b>Cables</b>	<b>334</b>
<b>Clam Cleats</b>	<b>245</b>
<b>Can Holder</b>	<b>204,356</b>
<b>Canopy</b>	
Adjustable strap	226,247
Aluminium	223
Clamp-on	225
Clevis fork	225
Connector	226-227
Cover for connector	227
Deck hinge	225-226
Eye end	225
Fabric	227
Fastener	218,227
Flushmount	225
Hinge	226
Hook	245
Mounting clip	225
Mounting 1-Wing	225
Mounting 2-Wings	225
Rowlock	226

Rowlock attachment	226
Sailboat	224
Stainless Steel	222
Suction disc	225
T - Fitting	213

**Canvas Hats** 384**Cap**

Captain's	384
Fisherman	384
Jockey	384

**Carpets** 231**Case**

Drink	202,354
Folding	203,355
For control panel	201,338
For deck filler	128,197,200
For electric power shore center	340
For fire extinguisher	56,202
For mixer tap	200,283
For shower/head	199-201,279-281
For toilet paper	199,292
General use	203-204,354-355
Mobile/VHF	203,354
Unbreakable	372
With battery switch	128,197,345
With deck filler	279-280,282-283
With net	204,355
With shower head	280
With water inlet/outlet	282-284

**Chain**

Connector	80
-----------	----

**Chains**

Galvanized	79-80
Inox	80

**Chairs** 218-219**Charge Controller** 343**Charts** 251,263-265,268**Chocks** 208**Cleaners** 395-396**Cleaning Products** 395-396,398**Cleat**

Deck	209
Flat line	208
Open base	209
Polyamide	209
Pull-up	209
U Bolt	209

**Clinometer** 246**Clip**

Adjustable	107
Folding	107
For pedestal	220
Mounting	225
Plastic	24,124
Support	27,107,124

**Clock** 356-357**Compass** 252-255**Connector**

Anchor	82
Brass	295-296
Female	158-159,341
Male	158-159

**Cooker** 351-352**Coolers**

Isothermal	352
Spare Parts	352

**Copper Sleeves** 236**Cord Sets** 341-342

<b>Cover</b>	
Boat	229
Console	229
Engine	133,228
Inflatable Lifejacket	14
Isotherm	202,354
Laser	168,230
Latch	215
Optimist	230
Power Inlet	341
Radio/Mp3	201-260
Stanchion	212
Tarpaulin	228
<b>Cup</b>	<b>353</b>
<b>Cushion</b>	<b>220</b>
<b>Cutlery</b>	<b>353</b>
<b>Cylinder</b>	
Compressed Air	53
CO <sub>2</sub>	13
<b>Davits</b>	<b>169</b>
<b>Deck</b>	
Chair	221
Clip	206
Filler	126-127,195-197
Hatches	191-194
Ventilation Systems	198
<b>Deck Plate</b>	
Round	189
With Pressure Lock	190
With Removable Bag	190
<b>Delta Ring</b>	<b>236,247</b>
<b>Director's Chair</b>	<b>221</b>
<b>Dividers</b>	<b>262</b>
<b>Drain</b>	
Plug	120,162,304-306,392
Socket	119,162,302,305-306
<b>Drains</b>	<b>298,301</b>
<b>Dry</b>	
Bags	18,56,385-387
Briefcase	120,387
<b>E EBD</b>	<b>52</b>
<b>Elbow Fittings</b>	<b>295</b>
<b>Ends</b>	
Eye	225-226
<b>EPIRB</b>	<b>60-61</b>
<b>Exhaust</b>	<b>161</b>
<b>Extension</b>	
Outboard Engine	134
Tiller	246
<b>Eyewear Retainers</b>	<b>388</b>
<b>Fairleads</b>	<b>209,238,244</b>
<b>Fan</b>	<b>357</b>
<b>Fastener</b>	
Door	214
Grommet Nut	217
Hatch	215
Hexagon nut	217
Sail	218,227

<b>Faucet</b>	<b>283</b>
<b>Fender</b>	
Adjuster	100
Basket	100
Cover	97,99
Hook	100,215
Profile	100
Valve Adapter	100
<b>Fenders</b>	
Bow	95,98,99
Center Hole	95
Clip-on	97
Dock	98,101
Heavy duty	94
Inflatable	96
Multipurpose	97
Optimist	95,167
Rope Through	95
Round	93
Stern	97,98
Utility	94
<b>Fins</b>	<b>370</b>
<b>Fire Blanket</b>	<b>56</b>
<b>Fire Extinguishers</b>	<b>55</b>
Brackets	55
<b>Fire Hose</b>	<b>53</b>
<b>Fire Hose Coupling</b>	<b>54</b>
<b>Fireman Axe</b>	<b>54</b>
<b>First Aid Box</b>	<b>51,62</b>
<b>Fishfinders</b>	<b>249-252</b>
<b>Fishing</b>	
Basket for longline	375
Flashing Light	375
Floats	103,376
Knife	371
Needle for fishing net	375
Reel for fishing line	375
Waders	381
<b>Fitting</b>	
Corner	212
For tank vent	156
Inlet	298
Outlet	303
Rail	213
Terminal	213
T-Shape	212-213,296
<b>Flag Pole</b>	
Base	212,232
Plug in	232
Polyamide	232
Stainless steel	232
<b>Flags</b>	<b>231</b>
<b>Flashing Light</b>	<b>375</b>
<b>Float Switch</b>	
Automatic	272-273
Electrical	273
<b>Footrest</b>	<b>111</b>
<b>Fuel</b>	
Valve	156
Vertical Sender	167
<b>Funnel</b>	
Extension	156
Filter	156
<b>Furling Ties</b>	<b>235</b>
<b>Fuse Holder</b>	<b>338-339</b>
<b>Fuses</b>	<b>91,338-339</b>
<b>Gangways</b>	<b>115</b>

<b>Gauge</b>	
Fuel level	167
Meter	126
Waste	167
<b>Glasses</b>	<b>353</b>
<b>Gloves</b>	<b>384,385</b>
<b>GPS</b>	<b>249-250,251-252</b>
<b>Grated Water Intake</b>	<b>296</b>
<b>Guide for Collision Regulations</b>	<b>266</b>
<b>Handle</b>	
Inflatable boat	119
Plastic	107,123
Ring Pull	216
Steering Wheel	138
<b>Handles</b>	
Aluminium for hook/brush	107,399
Chrome plated	216
Flow-Thru	399
Inox	216
Plastic	216
<b>Handrails</b>	<b>215-216</b>
<b>Hardcote &amp; PTEE</b>	<b>246</b>
<b>Hasp</b>	<b>211</b>
<b>Hatch</b>	
Adjuster	195
Cover	199
Door	179
Fastener	214-215
For VHF/RadioCD	190-191
Gasket	192,194-195
Handle	194,198,215-216
Insect Screen	194-195
Inspection	186-187,189,191-192
Key Handle	192
Lock	214
Opening Stay	182
Rectangular	174-184,186,188
Storage	175-185,187,190-191,198-199
<b>Headlamp</b>	<b>333</b>
<b>Hinge</b>	
Ladder	108,110
Polyamide	210
Reversed	210-211
Right	210-211
Stainless Steel	210-211
<b>Hob-Unit</b>	<b>351</b>
<b>Hook</b>	
Aluminium	106,376
Cabin	215
Carabiner	239
Fastener	215
Fender	215
For inflatable boat	120,225,230
Multi-purpose	203,214,238,355
Pelikan	237-238
Pine	106
Plastic	107
Safety	14
S-Hook	239
Snap	237-238
Spinnaker	238
Spring	238-239
Stainless Steel	239,376
Swivel eye snap	238
Telescopic	106,376
Trigger	238

With thread	107,124
Fishing	376
<b>Horn</b>	
Electric Air	165-166
Electromagnetic	165-166
Fog	58
Head only	164
Mouth	58
Refill canister	58,164
Set with canister	58,164
Stainless Steel	164
Switch	340
<b>Horseshoe</b>	
Case	30
Holder	30
<b>Hose</b>	
Accessories	159,293-294,307
Boat Sanitary	294
Exhaust	294
Fuel	159
Liquid Discharge & Water Delivery	293-294
Stainless Steel	212,225
<b>Hose Clamp</b>	
Inox	294
<b>Hydrostatic Release</b>	
For Life raft	49
<b>Immersion Suits</b>	<b>35</b>
<b>Impellers</b>	
Bukh	143
Caterpillar	144
Chrysler-Force	141
Cummins	148
Diesel	144
Evinrude	140
Garoni	148
Honda	140
Jabsco	147-148
Johnson	140,146
Mercruiser	143
Mercury	141
Oberdorfer	145
Onan	144
Perkins	143
Renault	142
Sherwood	143
Sole	141
Suzuki	141
Tohatsu	141
Volvo-Penta	145
Westerbeke	144
Yamaha	142
Yanmar	142
<b>Inflatable Boats</b>	<b>117-118</b>
<b>Inflatable Boat</b>	
Davits-Roll Bars	128,169
Drain Sockets	119,162,305,306
Handle	119,
Paddles	122-123
Repair kit	121,394-395
Storage	120,387
Transom Pads	133,
Valves	120
<b>Inspection Device</b>	<b>36</b>
<b>International Marine</b>	<b>232</b>

<b>Jacket</b>	
Fishermen	381
Inshore Sailing	379

<b>Key Chains</b>	<b>140,357</b>
<b>Knives</b>	
Diving	371
Marine	394

<b>Labels for Switch Panels</b>	<b>337</b>
---------------------------------	------------

<b>Ladder</b>	
Connection	110
Base	111
Hey hole plate	108,110
Hinge	108
Mounting Bracket	108
Support	110

<b>Ladders</b>	
Aluminium	108,111
Bow	109,114
Folding	109-113
Platform	113-114
Raft	109
Rope	108
Safety	31
Stainless Steel	108,111-112
Telescopic	112,114
Transom	110-111
<b>Lamp</b>	<b>331</b>
<b>Laser Cover</b>	<b>168,230</b>
<b>Letter Case</b>	<b>392</b>
<b>Letters</b>	<b>392</b>

<b>Lifebuoy</b>	
Holder	26-27
Horseshoe	29
Light	24-25
Ring	26-28,51
<b>Lifebuoy Ring</b>	
Case	29
Container	28
Non-SOLAS	26
Set	27
SOLAS	26
<b>Lifejacket</b>	
Cover	14
Dry bags	18, 387
Lights	23-24
Re-arm Kit	13
Sprayhood	13

<b>Lifejackets</b>	
Child	16
Belt	15
Inflatable	5-12
ISO Foam	5,16-17,20
Kid's	17
Solas	11-12,18-19
Work vest	20

<b>Liferaft</b>	
Base	50,52
Food/Water	50
Hydrostatic Release	49
Lashing	49
Light	333
Valve	52

<b>Liferafts</b>	
ISO	36-46
SOLAS	46-48
<b>Lifesaving Apparatus</b>	<b>34</b>
<b>Light</b>	
Base	24,30,119,322-323,
Cap	333
Courtesy	332
Dome	172,329,331-333
Flood	333
LED Tape	332
Lifebuoy	24-25
Lifejacket	23-24
Liferaft	49,333
Solar	331
Underwater	332
<b>Line Thrower</b>	<b>57</b>
<b>Log Books</b>	<b>269</b>

<b>Mask</b>	<b>369-370</b>
<b>Megaphone</b>	<b>58,260</b>

<b>Mooring</b>	
Buoy	101-103
Ring	28
Rubber compensator	86
Spring	86
<b>Mosquito Repellent</b>	<b>357</b>

<b>Motor</b>	
Flusher	135
Lock	134,214
Trolley	135
<b>Mugs</b>	<b>353</b>
<b>Multi-Function Tool</b>	<b>394</b>

<b>Navigation Lights</b>	
All-Round	318,320-322,327-328,330
Bi-colour	315,317,319-322,324,326-330,
Combination	328-329
Fixed	326-327
Folding	323,
Masthead	315,319-320-321,324-330,
Plug-in	323
Pole	314,323
Port & Starboard	314-316,319-322,324-330,
Portable	119,322
Stern	315,317,320-322,324-330
Telescopic	323,
Tri-colour	317-318,320-322,330
<b>Navigation Plotter</b>	<b>249-252</b>
<b>Nets for Bowrail</b>	<b>213</b>

<b>Oarlock</b>	
Holder	125
Polymide	125
Set	125
Socket	119,124,125
<b>Oil Extractor</b>	<b>161</b>
<b>Oil Measurer</b>	<b>156</b>
<b>Optimist</b>	
Accessories	168,230
Cover	168,230

Deck Collar	168
Fenders	167
Hiking Straps	168,230
<b>Outboard</b>	
Safety Lock	134,214
Tiller	134
<b>Outboard Engines</b>	<b>129-131</b>
Propellers	132
Propeller guard	132
Oils	136

## Pad

Outboard Transom	132,133
Stainless Steel	205,206
Transom	133

<b>Pad Eyes</b>	<b>205</b>
-----------------	------------

## Paddles

Blades	123
Buoyant	52, 121
Clip Holder	24, 107,124
Collar	123,124
End cap	123
Dismountable	123
Double Palm Grip	121
For Inflatable Boat	122,123
Handle	107,123
Kayak	122,123
Oarlocks	124,125
Palm Grip	122
Standard	122
Support clip	107,124
Telescopic	122,123
With Hook	122,123
With Removable Blade	121

<b>Padlocks</b>	<b>214</b>
-----------------	------------

Parallel Ruler	262
----------------	-----

Pilot Maps	265
------------	-----

Pin	237
-----	-----

Plastic Ties	159
--------------	-----

Plates	353
--------	-----

Platforms	114-115
-----------	---------

## Plug

Brass	295-296
Drain	119,162,305-306
Electric	341

Pole	230
------	-----

Polishing Cream	395
-----------------	-----

Polyurethane	394
--------------	-----

Portlight	193
-----------	-----

Power Inverter	343
----------------	-----

Press Stud	227
------------	-----

Pressure Switches	275
-------------------	-----

Primer Bulbs	157,320-323,328-330,
--------------	----------------------

Protractor	263
------------	-----

Pull Pin	227
----------	-----

## Pumps

Accessories	126
Automatic Water	277
Bilge	271-272
Double Action	125,126
Electric	125,275-277
Foot Pump	119,125,274
Hand	274
Impellers	143-148
Macerator	278
Oil Change	161
Suction	157,278

Spare Parts	275-277
-------------	---------

Water	274-275,277-278,374
-------	---------------------

Water / Fuel	272
--------------	-----

Watertight	375
------------	-----

<b>Radar Reflector</b>	<b>59</b>
------------------------	-----------

Radio-CD Housing	201,260
------------------	---------

Radio/MP3	260,367
-----------	---------

Rail support	30, 100
--------------	---------

Raincoats & Rainsuits	380
-----------------------	-----

Ratchet Tie-Downs	15, 171,226
-------------------	-------------

Reducer	295-296
---------	---------

Refill Canister	58
-----------------	----

## Repair Kit

For foot pump	274
---------------	-----

For hand bilge pump	274
---------------------	-----

For inflatable boat	121,394-395
---------------------	-------------

Rescue System	25, 31, 33
---------------	------------

## Ring

Delta	236,247
-------	---------

D-Ring	236,247
--------	---------

Round	236
-------	-----

## Rod

Base	374
------	-----

Holder	373-374
--------	---------

Holding Ring	373
--------------	-----

Storage Rack	373
--------------	-----

Support flush mount	373
---------------------	-----

Support side mount	373
--------------------	-----

Roll Bar	128
----------	-----

Roller	171,366
--------	---------

## Rope

Anchor	84
--------	----

Crusing	234
---------	-----

Dyneema	234,375
---------	---------

Engine Starter	134
----------------	-----

Fender	100
--------	-----

Floating	30
----------	----

Longline Fishing	374
------------------	-----

Mooring	84-86
---------	-------

Multiple use	235
--------------	-----

Polyester	234
-----------	-----

Scotta	234
--------	-----

Ski	366
-----	-----

Stretchcord	235
-------------	-----

Superline Braided	234,375
-------------------	---------

Tow Rope	366
----------	-----

Wind-surf	234
-----------	-----

Rope Stopper	245
--------------	-----

Rudder Retaining Clip	246
-----------------------	-----

<b>Safety Harness</b>	<b>33</b>
-----------------------	-----------

Safety Line	14, 33
-------------	--------

## Screen

Door Insect	195
-------------	-----

Fly/Mosquito	194
--------------	-----

Hatch Insect	195
--------------	-----

## Screws

Chipboard	217
-----------	-----

Hexagon	217
---------	-----

Self-tapping	217
--------------	-----

Slotted countersunk head	216
--------------------------	-----

Scupper	160
---------	-----

Sea Guide	265
-----------	-----

Sensors	250
---------	-----

## Shackle

"D" type	80,206-207
----------	------------

"Ω" type	80,207
----------	--------

Clevis pin	208
------------	-----

Galvanised	84
------------	----

Halyard	207
---------	-----

Polyamide	238
-----------	-----

Long	207
------	-----

Snap	207
------	-----

Twist	207
-------	-----

U Shape	208
---------	-----

Sheaves	244
---------	-----

Shock Cord olive	234
------------------	-----

## Shoes

Deck	383
------	-----

Sportive	383
----------	-----

## Shower

Head	279
------	-----

Hose	279
------	-----

Sump System	281
-------------	-----

Tank	290
------	-----

Smoke Detectors	60
-----------------	----

Smoke Signals	57
---------------	----

Signaling Mirror	51, 58-59
------------------	-----------

Silencer	161
----------	-----

## Ski

Rope	366
------	-----

Transom Mount	366
---------------	-----

Ski Tubes	361-365
-----------	---------

Snorkel	369
---------	-----

Sockets	341-342
---------	---------

Solar Panels	342
--------------	-----

Solvents	390
----------	-----

## Spares

For EEBD	52
----------	----

Speakers	261,346,367-368
----------	-----------------

Sprayhood	11,13
-----------	-------

Spreader Boots	245
----------------	-----

## Steering Wheel

Adaptor	137
---------	-----

Bezel Kit	136
-----------	-----

Cable	137
-------	-----

Control side mount	139
--------------------	-----

Handle bar	138
------------	-----

Helm	136-137
------	---------

Steering Wheels	137,138
-----------------	---------

Steps	108,111
-------	---------

Stickers	393
----------	-----

Storage Bottle	57,155
----------------	--------

Straight Coupling	295
-------------------	-----

Strap Buckle	20, 226
--------------	---------

Strum box	312
-----------	-----

Strainers	312
-----------	-----

Sunglasses	388
------------	-----

## SUP

Boards	360
--------	-----

Paddle	360
--------	-----

Surveillance System	257
---------------------	-----

Synthetic Skin Cleaner	
------------------------	--

Swimming Goggles	368
------------------	-----

## Switch Panel

Base	335
------	-----

Function Labels	335,337
-----------------	---------

Key	335-337,339
-----	-------------

Switch Panels	336-338
---------------	---------

## Switches

Battery	345
---------	-----

Electric toilet flush	292
-----------------------	-----

Ignition Starter	139
------------------	-----

Kill Switch	139
-------------	-----

On/Off/Mon	335,337-340
------------	-------------

Pump	273,335
------	---------

Push/Pull Button	340
------------------	-----

Windlass	335
----------	-----

Swivels	83
---------	----

**T**

Aluminium	221
Bottom Plate	220
Pedestal	221
Support bracket	221
Top	220
Top Plate	220

**Tank**

Accessories	52, 152-157, 167, 285, 287, 289, 344
Flexible	289
Fuel	152-155
Fuel Vent	160
Plate	285
Waste	285, 288
Water	284-287, 289-290
Water pump	278
With Spout	154
<b>Tap</b>	<b>283, 284</b>

**Tapes**

Duct	247, 391
Masking	247, 391
Mounting	247, 392
Neoprene	247, 392
Nonslip	247, 391
Solas	35
Thermal & Sound Insulating	247, 392

**Tarpaulin Cover** 228**Teak**

Cleaner	391
Sealer	391

**Tee Connection** 212, 213**Thermal Blankets** 51**Thermal Switches** 337-338**Thermometer** 356-357**Thimbles** 84**Thru-Hull Fitting**

Brass	307
Elbow	289, 301, 303
Flush flange	297
Set	301
Standard flange	299
Straight	289-297, 303
Telescopic	302
Threaded	299, 302
With hose barb	300-301
With non-return valve	302, 304

**Thruster**

Control Panel	92
Radio remote control	93

**Thrusters**

Electric Retractable	90
Electric Tunnel	87
Hydraulic Retractable	90-91
Hydraulic Tunnel	88-89
Ignition Protected	88
Stern Pod	89

**Thinners** 390**Toilet**

Base	290
Case/Holder for Paper	199, 292
Chemical	290
Cleaning Fluid	290
Disinfectant Sanitizing Unit	293
Electric	291
Manual	291
Repair kit	291-292
Spare kit	290, 292
Switch	292
<b>Tool Kit</b>	<b>393</b>
<b>Torches</b>	<b>333</b>

**Trailer**

Female plug	172
Jockey wheel	172
Lights	172, 333
Male plug	172
Spare Tire Mounts	172
Spool keel roller	171
Wheel for jockey	172
Winch cable	171

**Trim Tabs**

Engine	135
--------	-----

**Trousers**

Fisherman	381
Sailing	379

**Tube**

Inox	212, 225
Socket	213

**Turnbuckles** 237**USB Charger** 341**V**

Inflating adaptor	126
Key	119, 126
Water tank	52

**Valves**

Anti-vent loop	292
Ball	306, 307
Inflating	120
Non-return	120, 162, 303-305
Shut-off	155
Water tank	52
Way	155, 156
"Y" Type	306

**Varnishes** 390-391**Vent**

Bilge blower	160, 310, 343
Clamshell	308
Double	308
Fuel tank	160
Rectangular	308
Round	307
Solar powered	311
With flange	307
With water outlet	308

**Ventilator**

Cabin	311-312
Connector	308-310
Cover	308
Tank	159
Shaft drills	309
Stainless steel	311-312

**Ventilators** 160-161, 310-312**VHF** 252**VHF Micro Bracket** 259**W**

Washer	217
Water Accumulator	277
Water and food	50
Water Intake	304-305
Water Toys	369
Waterproof Connection Box	339

**Wax** 395**Webbing** 227, 247**Welcome Mats** 231**Wetsuits**

Neoprene	370, 382
----------	----------

**Whistle** 58**Winch**

Strap	170
Trailer	170

**Winch Handle**

Aluminium	79, 235
Case	236
Floating	79, 235
Holder	236
Glass reinforced PA	79, 235

**Wind Indicator** 245**Windlass**

Capstans	73-74
Chain Counter	75-76, 92
Chain Pipe	75
Chain Stopper	75
Control Switch	76-77
Gypsy	78
Footswitch	77
Hand held Control	76
Handle	235
Maintenance Kit	77
Radio Control	75-77
Stern Base	70

**Windlasses**

Horizontal	70-73
Vertical	65-70

**Windshield Wipers** 162-163**Wiper****Arms/Blades** 163-164**Wire Rope**

Clip	236
Stainless steel	236

**Workwear** 380





Safety

Anchoring, Docking & Mooring

Boats, Engines & Accessories

Deck Equipment

Sailing Hardware

Electronics & Navigation

Plumbing & Ventilation

Electrical Equipment

Interior Equipment & Galley

Watersports & Fishing

Clothing & Accessories

Cleaning & Maintenance



## Retail Stores Network

### GREECE

#### PIRAEUS

3 Gounari, PC 18531,  
Tel.: +30 210 4177020, Fax.:+30 210 4226273,  
e-mail:peiraias@marinastores.gr

#### GERAKAS

78 Marathonos Av. , PC 15344,  
Tel.: +30 210 6617910,  
e-mail: gerakas@marinastores.gr

#### PATRA

50 Iroon Politechniou, PC 26441  
Tel. : +30 2610 462065,  
e-mail: patra@marinastores.gr

#### THESSALONIKI

103 Themistokli Sofouli Avenue, PC 55131,  
Tel : +30 2310 417858,  
e-mail thessaloniki1@marinastores.gr

### CYPRUS

#### LEMESOS

Franklinou Roosvelt Avenue 166, 3045,  
Tel.: +357 25384999, Fax: +357 25384488,  
e-mail: limassol@marinastores.gr

### MONTENEGRO

#### CRNA GORA, TIVAT

Gornji Kalimanj II br. 15,  
Tel: +382 68 063 222,  
e-mail: tivat@lalizas.com /  
montenegroinfo@lalizas.com

#### CRNA GORA, BAOŠIĆI

Druga Baošićka 33  
Tel: +382 67 00 22 10,  
e-mail: baosici@lalizas.com

### CROATIA

#### MEGASTORE SPLIT

Lovački put 1  
Tel: +385 21 490 709,  
e-mail: split@lalizas.com

#### ZAGREB

Cvjetna Cesta 11  
Tel.: +385 1 618 3342,  
e-mail: zagreb@lalizas.com

#### PULA

Riva 14  
Tel.: +385 52 210 904,  
e-mail: pula@lalizas.com

#### MEGASTORE RIJEKA

Zdravka Kučića 38b, Vežica - Rijeka  
Tel: +385 51 343 173,  
e-mail: rijeka@lalizas.com

#### MEGASTORE ŠIBENIK

Borajska cesta bb,  
Tel.: +385 22 212 268,  
e-mail: sibenik@lalizas.com

#### MEGASTORE ZADAR

Franka Lisice 91  
Tel: +385 23 302 147,  
e-mail: zadar@lalizas.com

#### DUBROVNIK

Na Skali 4, Mokošica  
Tel.: +385 20 454 079,  
e-mail: dubrovnik@lalizas.com

Obala pape Ivana Pavla II. br.24, Gruž

Tel.: +385 20 313 063, e-mail: gruz@lalizas.com

#### MAKARSKA

Kralja Zvonimira 3  
Tel.: +385 21 679 389,  
e-mail: makarska@lalizas.com